

P/N LEGEND

A12514	WR-S-XP	N	L	X	T1	T	00	R
①	②	③	④	⑤	⑥	⑦	⑧	⑨

① Series No.  
 ② Connector type: WR=Right angle  
 ③ Mounting type: S=SMT TYPE  
 ④ No. of circuits  
 ⑤ N=Halogen Free  
 ⑥ Material: L=LCP ;  
 ⑦ Color: N=Natural ; B=Black  
 ⑧ Plating code for contacts:  
 T1=Matte Tin-plated;  
 ⑨ Plating code for solder tabs:  
 T=Matte Tin-plated;  
 ⑩ Option code: 00=Standard  
 ⑪ Packing code: R=Tape & Reel

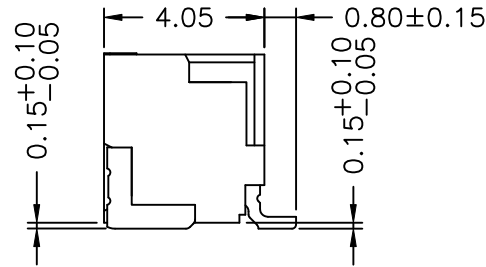
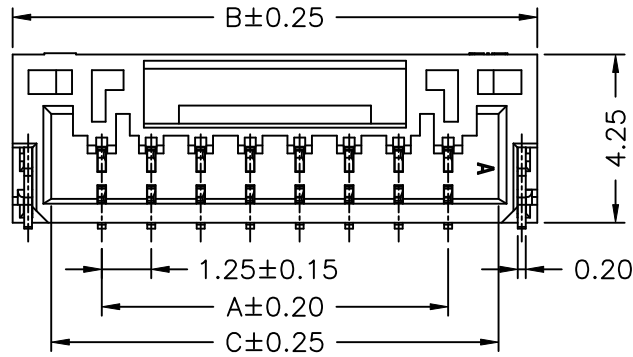

SPECIFICATIONS

Current Rating: 1A AC,DC  
 Voltage Rating: 50V AC,DC  
 Temperature Range: -25°C ~ +85°C  
 Contact Resistance: 30mΩ Max.  
 Insulation Resistance: 100MΩ Min.  
 Withstanding Voltage: 500V AC/minute  
 Pin Material: Phosphor Bronze  
 Solder Tabs: Brass

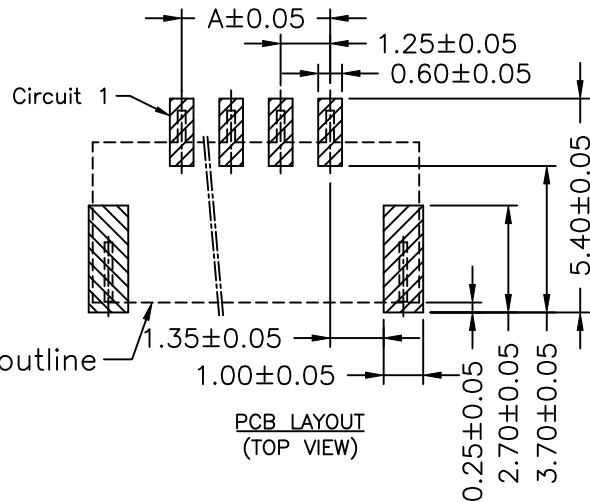

Circuit No.	Dimensions			Circuit No.	Dimensions		
	A	B	C		A	B	C
02P	1.25	5.75	3.80	09P	10.00	14.50	12.55
03P	2.50	7.00	5.05	10P	11.25	15.75	13.80
04P	3.75	8.25	6.30	11P	12.50	17.00	15.05
05P	5.00	9.50	7.55	12P	13.75	18.25	16.30
06P	6.25	10.75	8.80	13P	15.00	19.50	17.55
07P	7.50	12.00	10.05	14P	16.25	20.75	18.80
08P	8.75	13.25	11.30	15P	17.50	22.00	20.05

							燦達電子工業股份有限公司 JOINT TECH ELECTRONIC IND. CO., LTD.		
				UNIT	SCALE	SHEET	TITLE:		
B0	EN202210181201	2022.12.06	劉建芳	mm	1:1	1 of 3	1.25mm PITCH 90° WAFER-SMT TYPE		
A5	EN202206071082	2022.06.08	徐貴湖	DRAWN BY	徐富永	APPROVED BY			徐富永
A4	EN202204201026	2022.04.14	徐貴湖						
A3	EN20220331988	2022.02.18	徐貴湖	2020.06.17	2020.06.17				
A2	EN20210312583	2021.04.22	鄭小嬌	GENERAL TOLERANCE					
A1	EN20210113550	2021.03.23	鄭小嬌	X.X±0.25	ANGLE±				
A0	NEW RELEASE	2020.06.17	鄭小嬌	X.XX±0.15			DRAW NO.:	REV.	
REV.	DESCRIPTION	DATE	NAME	X.XXX±0.05			A12514WR-S-XPXXXXXXXR	B0	



# 塑膠各PIN外觀差異

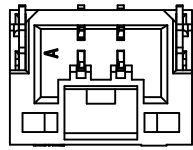

02P

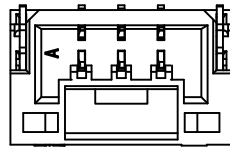

03P

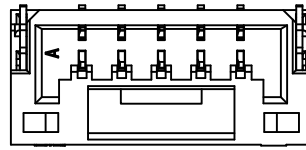

04~05P

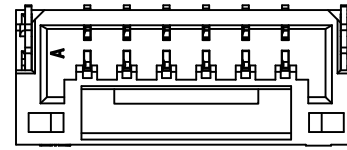

06P

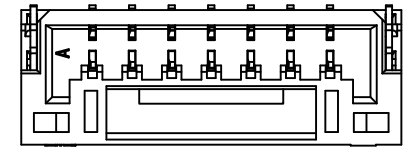

07P

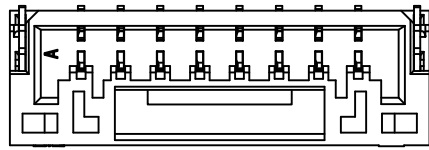

08P

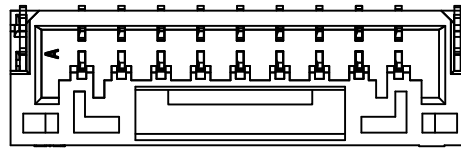

09P

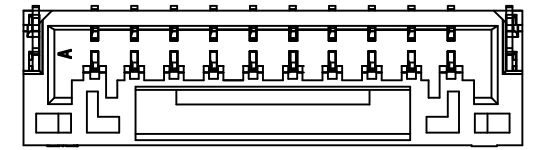

10P

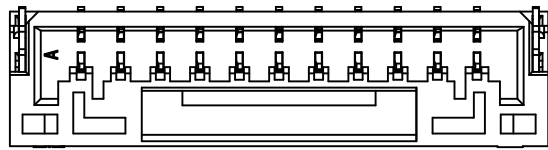

11P

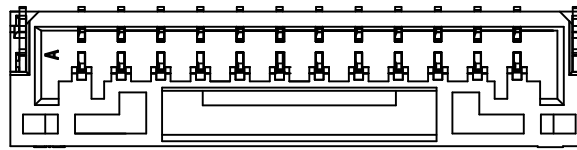

12P

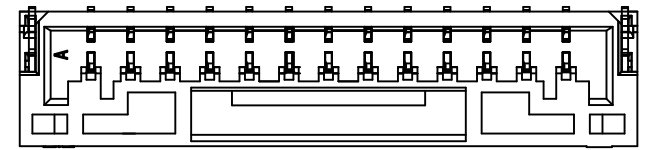

13P

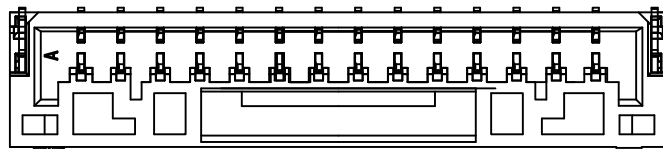

14P

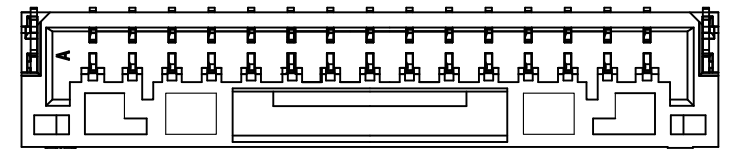

15P

				 燦達電子工業股份有限公司 JOINT TECH ELECTRONIC IND. CO., LTD.			
				UNIT	SCALE	SHEET	TITLE:  <b>1.25mm PITCH</b> <b>90° WAFER-SMT TYPE</b>  DRAW NO.: A12514WR-S-XPNXXXXXXXXR
B0	EN202210181201	2022.12.06	劉建芳	mm	1 : 1	2 of 3	
A5	EN202206071082	2022.06.08	徐貴湖	DRAWN BY 徐富永	APPROVED BY 徐富永	2020.06.17	
A4	EN202204201026	2022.04.14	徐貴湖				
A3	EN20220331988	2022.02.18	徐貴湖	GENERAL TOLERANCE			
A2	EN20210312583	2021.04.22	鄭小嬌	X. X±0.25	ANGLE±		
A1	EN20210113550	2021.03.23	鄭小嬌	X. XX±0.15			
A0	NEW RELEASE	2020.06.17	鄭小嬌	X. XXX±0.05			
REV.	DESCRIPTION	DATE	NAME				REV. B0

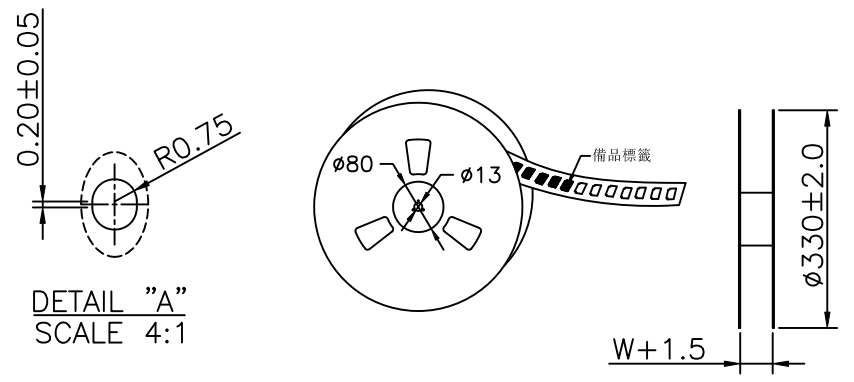
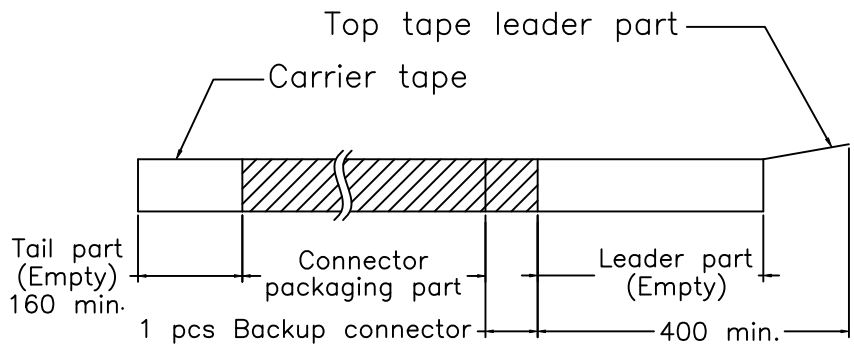
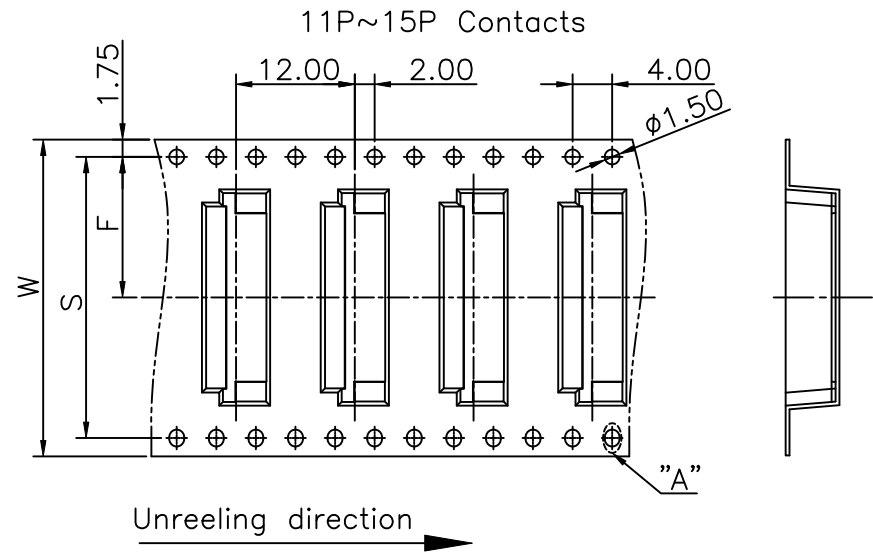
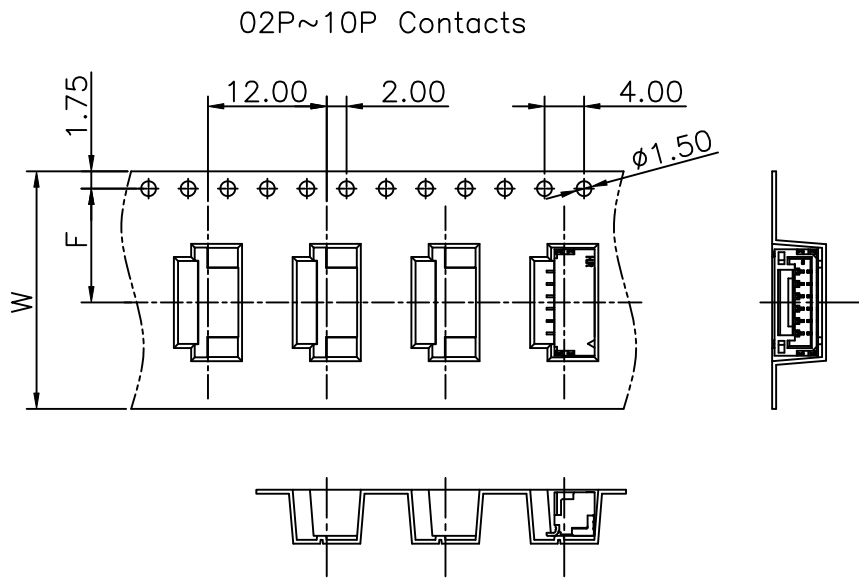

Number of Contacts	W±0.3	F±0.1	S±0.1	Q'ty/Reel
02P	16.00	7.50	/	1,000
03P				
04P				
05P				
06P				
07P	24.00	11.50		
08P				
09P				
10P	32.00	14.20	28.40	
11P				
12P				
13P				
14P				
15P	44.00	20.20	40.40	

							燦達電子工業股份有限公司 JOINT TECH ELECTRONIC IND. CO., LTD.		
				UNIT	SCALE	SHEET	TITLE:		
B0	EN202210181201	2022.12.06	劉建芳	mm	1:1	3 of 3	1.25mm PITCH 90° WAFER-SMT TYPE TAPING SPEC.		
A5	EN202206071082	2022.06.08	徐貴湖	DRAWN BY	徐富永	APPROVED BY			徐富永
A4	EN202204201026	2022.04.14	徐貴湖						
A3	EN20220331988	2022.02.18	徐貴湖	2020.06.17	2020.06.17				
A2	EN20210312583	2021.04.22	鄭小嬌	GENERAL TOLERANCE					
A1	EN20210113550	2021.03.23	鄭小嬌	X. X±0.25	ANGLE±				
A0	NEW RELEASE	2020.06.17	鄭小嬌	X. XX±0.15					
REV.	DESCRIPTION	DATE	NAME	X. XXX±0.05					
							DRAW NO.:	REV.	
							A12514WR-S-XPNXXXXXXXR	B0	

## X-ON Electronics

Largest Supplier of Electrical and Electronic Components

*Click to view similar products for [Headers & Wire Housings](#) category:*

*Click to view products by [Joint Tech](#) manufacturer:*

Other Similar products are found below :

[0015917161](#) [0022155065](#) [57102-F02-18ULF](#) [58102-G61-06LF](#) [582553-1](#) [01.001.5753.1](#) [0050291907](#) [02.125.8002.8](#) [609-3404](#) [61062-3](#)  
[CSU011177004](#) [622-0430](#) [622-3653LF](#) [63453-116](#) [636-1030](#) [636-1427](#) [636-3427](#) [636-4007](#) [641938-9](#) [644827-2](#) [65495-038](#) [65692-001LF](#)  
[65781-018](#) [65781-047](#) [65817-010LF](#) [65817-015LF](#) [67095-007LF](#) [67601157](#) [68631-112](#) [68645-018](#) [699319-000](#) [70.362.1628.0](#) [70-4210](#) [70-4226B](#) [70-4853B](#) [71.350.2428.0](#) [733-134](#) [733-162](#) [760-3052](#) [MHR-64-VUAL](#) [80.063.4001.1](#) [800-90-001-10-001000](#) [801-43-002-10-013000](#)  
[801-43-006-10-002000](#) [803-43-024-10-001000](#) [803-93-012-10-001000](#) [8-1437020-4](#) [819-22-004-30-001101](#) [820-22-006-30-001101](#)  
[821-22-002-10-001101](#)