

TO MAKE SURE THE CAP CAN BE PUT ON THE MIDPOINT FOR 04P TO 15P.

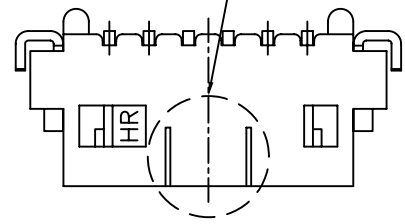

Circuit 1 0.95±0.10

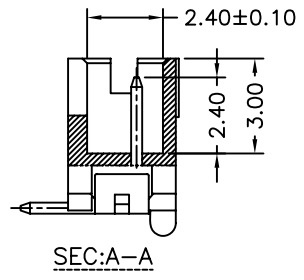
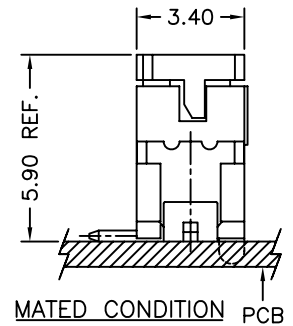
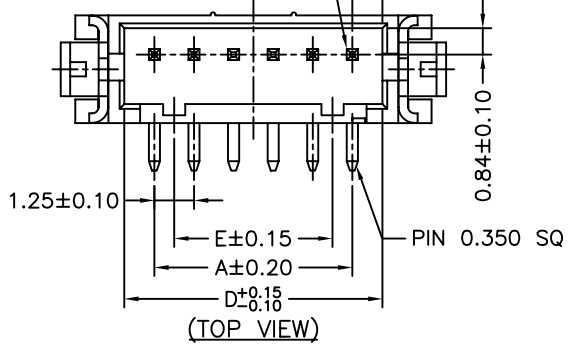

P/N LEGEND

A1252					WV-SF-XP					XXX				
①	②	③	④	⑤	①	②	③	④	⑤	①	②	③	④	⑤
① Series No.														
② Connector type: WV=Vertical														
③ Mounting type: SF=SMT with boss														
④ No. of circuits														
⑤ Option code:														
D01=Contacts/Gold-flash and Solder tabs/Gold-flash Color: Natural(Beige)														
D11=Contacts/Gold-flash and Solder tabs/Gold-flash Color: Natural(Black)														

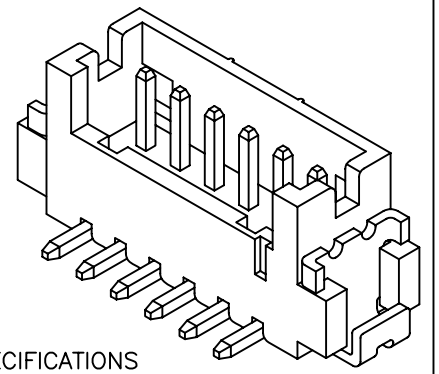

SPECIFICATIONS

Current Rating: 1A AC,DC
 Voltage Rating: 150V AC,DC
 Temperature Range: -25°C ~ +85°C
 Contact Resistance: 30mΩ Max.
 Insulation Resistance: 500MΩ Min.
 Withstanding Voltage: 500V AC/minute
 Pin Material: Brass
 Solder Tabs: Phosphor Broze
 Wafer: Nylon 6T,UL94V-0
 Cap: Nylon 6T,UL94V-0

Circuit No.	Dimensions				
	A	B	C	D	E
02P	1.25	4.15	6.25	3.15	---
03P	2.50	5.40	7.50	4.40	1.25
04P	3.75	6.65	8.75	5.65	2.50
05P	5.00	7.90	10.00	6.90	3.75
06P	6.25	9.15	11.25	8.15	5.00
07P	7.50	10.40	12.50	9.40	6.25
08P	8.75	11.65	13.75	10.65	7.50
09P	10.00	12.90	15.00	11.90	8.75
10P	11.25	14.15	16.25	13.15	10.00
11P	12.50	15.40	17.50	14.40	11.25
12P	13.75	16.65	18.75	15.65	12.50
13P	15.00	17.90	20.00	16.90	13.75
14P	16.25	19.15	21.25	18.15	15.00
15P	17.50	20.40	22.50	19.40	16.25

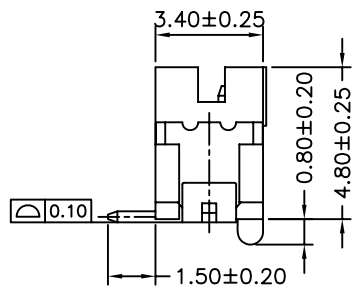
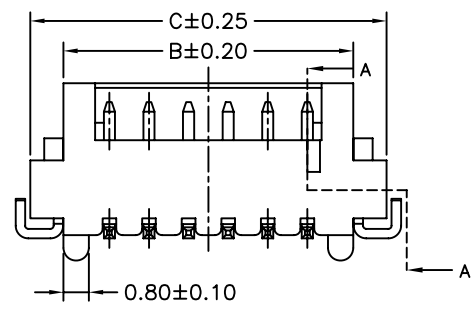
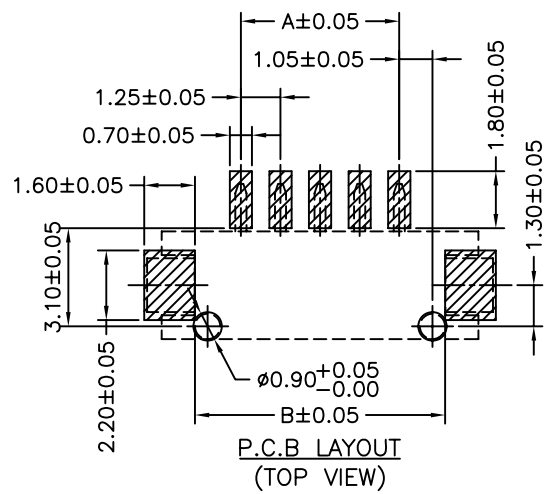

						燦達電子工業股份有限公司 JOINT TECH ELECTRONIC IND. CO., LTD.	
		UNIT	SCALE	SHEET		TITLE:	
		mm	1 : 1	1 of 2		1.25mm PITCH 180° SINGLE ROW WAFER- SMT TYPE	
		DRAWN BY		APPROVED BY		DRAW NO. :	
		李勤		董正一		A1252WV-SF-XP	
		2006.05.31		2006.05.31		REV. A5	
		GENERAL TOLERANCE					
A5	EN1208210276	2012.09.12	陳錦展	X.X±0.25	ANGLE±		
A4	EN1202060018	2012.02.06	陳錦展	X.XX±0.15			
A3	EN1106240218	2011.06.24	陳敏	X.XXX±0.05			
A2	EN1012010279	2010.12.01	陳錦展				
REV.	DESCRIPTION	DATE	NAME				

X-ON Electronics

Largest Supplier of Electrical and Electronic Components

Click to view similar products for [Headers & Wire Housings](#) category:

Click to view products by [Joint Tech](#) manufacturer:

Other Similar products are found below :

[57102-F02-18ULF](#) [58102-G61-06LF](#) [0009485154](#) [009176003701906](#) [0050291907](#) [02.125.8002.8](#) [609-3404](#) [61062-3](#) [622-0430](#) [622-3653LF](#)
[63453-116](#) [636-1030](#) [636-1427](#) [636-3427](#) [636-4007](#) [641938-9](#) [644827-2](#) [65495-038](#) [65692-001LF](#) [65781-018](#) [65781-047](#) [65817-010LF](#)
[65817-015LF](#) [66207-023LF](#) [67016-026LF](#) [67095-007LF](#) [68631-112](#) [68645-018](#) [68648-049](#) [699319-000](#) [70.362.1628.0](#) [70-4210](#) [70-4226B](#)
[70-4853B](#) [707-5020](#) [707-5028](#) [71.350.2428.0](#) [71961-016LF](#) [733-134](#) [754199-000](#) [760-3052](#) [787-8014-00](#) [FCN-367T-T012/H](#) [80.063.4001.1](#)
[800-90-001-10-001000](#) [800-90-010-10-002000](#) [801-43-002-10-013000](#) [801-43-006-10-002000](#) [803-41-018-10-001000](#) [803-43-014-20-](#)
[001000](#)