

REV.	B4	EN1609220001	2016.09.22	周傑亮	GENERAL TOLERANCE	ANGLES	
B3	EN1105260153	2011.05.26	陳敏	X.XX±0.25	2007.12.26	DRAWN BY 歐陽小強 謝瑞清 APPROVED BY 1 : 1   1 of 2 mm SCALE SHEET	
B2	EN1012140291	2010.12.14	陳敏	X.XX±0.15	2007.12.26		
B1				X.XX±0.05			
DRAW NO.:		A1253 WRA-S-XP		DRAWN BY		TITLE:	
REV.		A1253WRA-S-XP		DRAWN BY		TITLE:	

**燦達電子工業股份有限公司**  
 JOINT TECH ELECTRONIC IND. CO., LTD.

1.25mm PITCH  
 90° WAFER-SMT TYPE,  
 WITHOUT BOSS

Circuit	Dimensions		
	No.	A	B
02P	1.25	7.45	3.50
03P	2.50	8.70	3.50
04P	3.75	9.95	3.50
05P	5.00	11.20	3.50
06P	6.25	12.45	3.50
07P	7.50	13.70	3.50
08P	8.75	14.95	3.50
09P	10.00	16.20	3.50
10P	11.25	17.45	3.50
11P	12.50	18.70	5.00
12P	13.75	19.95	5.00
13P	15.00	21.20	5.00
14P	16.25	22.45	5.00
15P	17.50	23.70	5.00
20P	23.75	29.95	5.00
25P	30.00	36.20	6.00
30P	36.25	42.45	6.00

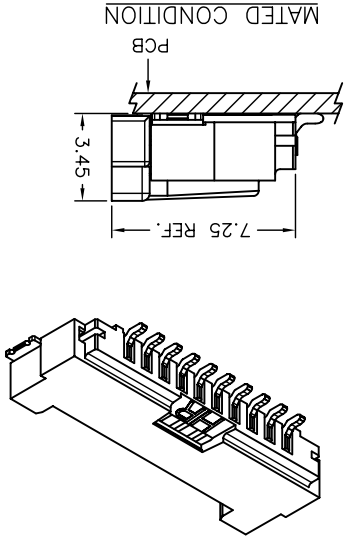

**P/N LEGEND**

A1253 WRA-S-XP XXX  
 ① Series No.  
 ② Connector type: WR=Right angle A Type  
 ③ Mounting type: S=SMT Type  
 ④ No. of circuits  
 ⑤ Option code:  
 Blank=Contacts/Matte Tin-plated  
 D01=Contacts/Gold-flash and Solder Tabs/Matte Tin-plated  
 D02=Contacts/Gold-flash and Solder tabs/Gold-flash  
 D20=Contacts/Gold-flash and Solder tabs/Gold-flash with Mylar  
 C=Contacts/Matte Tin-plated  
 Solder Tabs/Matte Tin-plated With Mylar

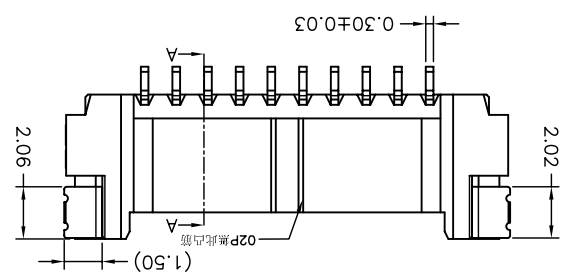
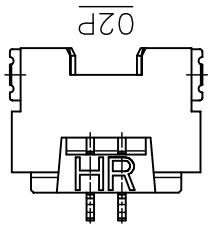
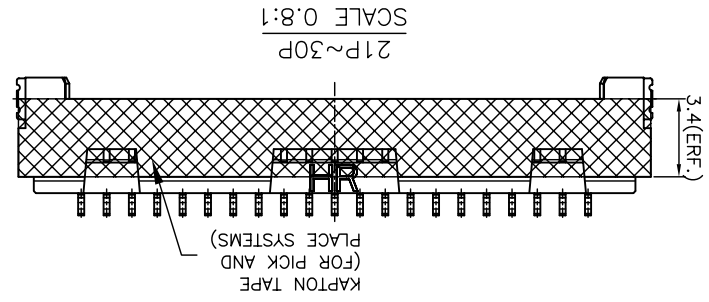
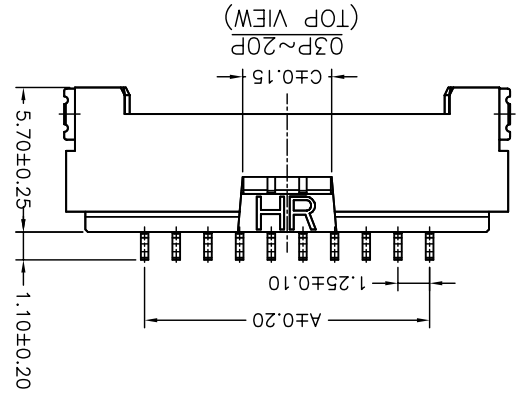
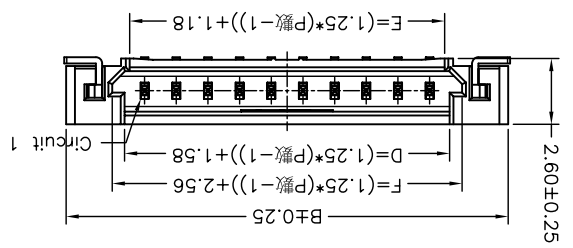
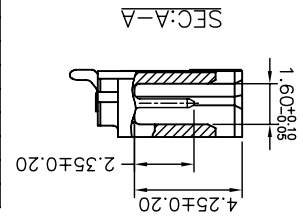
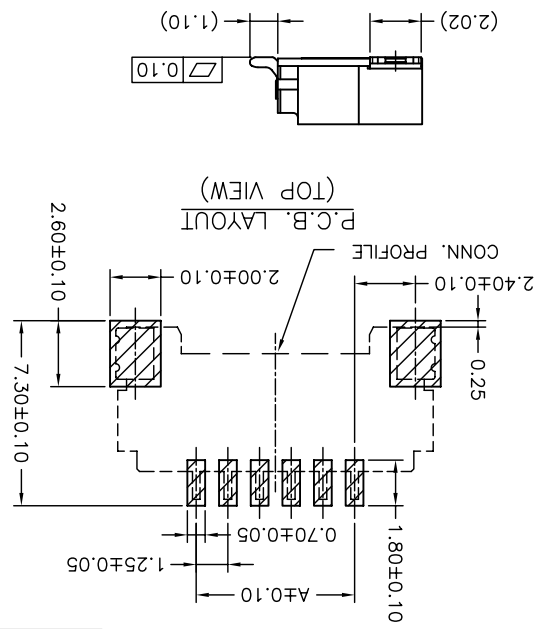

1 2 3 4

A B C D

Number of Contacts	WF±0.3	FF±0.1	S±0.1	Q'ty/Reel
02P	16	7.50	1,000	1,000
03P	24	11.50	1,000	1,000
04P	24	11.50	1,000	1,000
05P	24	11.50	1,000	1,000
06P	24	11.50	1,000	1,000
07P	24	11.50	1,000	1,000
08P	32	14.20	28.40	1,000
09P	32	14.20	28.40	1,000
10P	32	14.20	28.40	1,000
11P	32	14.20	28.40	1,000
12P	32	14.20	28.40	1,000
13P	44	20.20	40.40	1,000
14P	44	20.20	40.40	1,000
15P	44	20.20	40.40	1,000
20P	44	20.20	40.40	1,000
25P	56	26.20	52.40	1,000
30P	56	26.20	52.40	1,000

NOTE:  
Material:Transparent  
Anti-static Polystyrene.

REV.	DESCRIPTION	DATE	NAME	DATE	NAME
B4	EN160922001	2016.09.22	周傑亮	2016.09.22	周傑亮
B3	EN1105260153	2011.05.26	陳敏	2011.05.26	陳敏
B2	EN1012140291	2010.12.14	陳敏	2010.12.14	陳敏
B1					

DRAWN BY	謝瑞清	2007.12.26	GENERAL TOLERANCE
APPROVED BY	歐陽小強	2007.12.26	
UNIT	mm	SCALE	1 : 1
SHEET	2 of 2	TITLE:	90° WAFER-SMT TYPE, WITHOUT BOSS TAPING SPEC.
REV.	B4	DRAW NO.:	A153WRA-S-XP

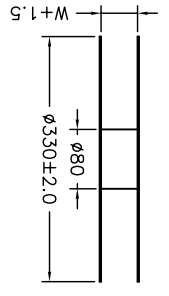
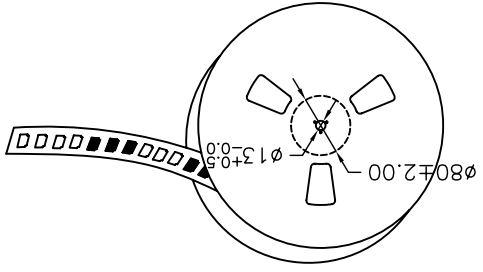
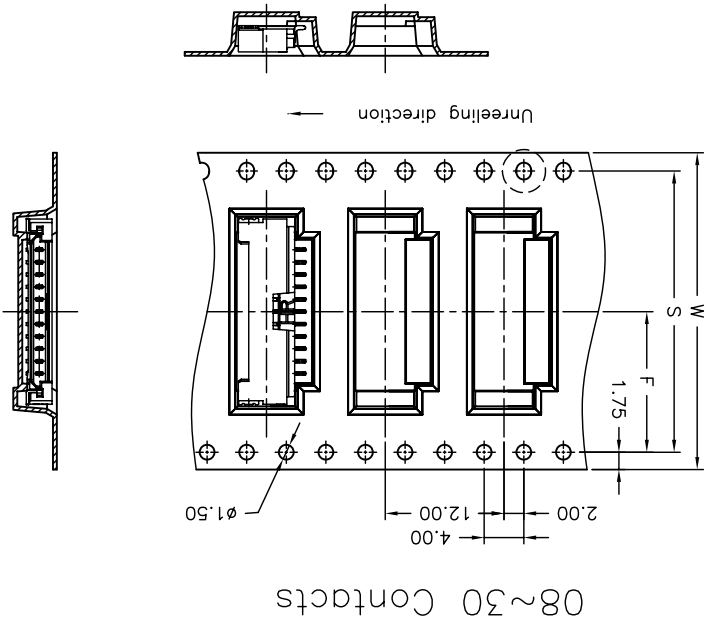
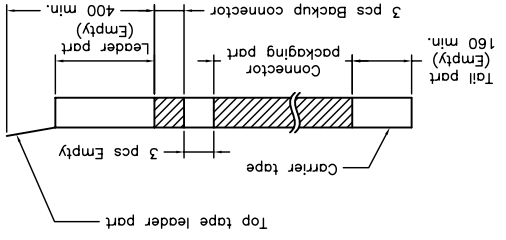
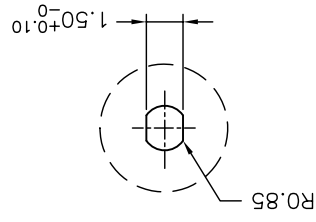
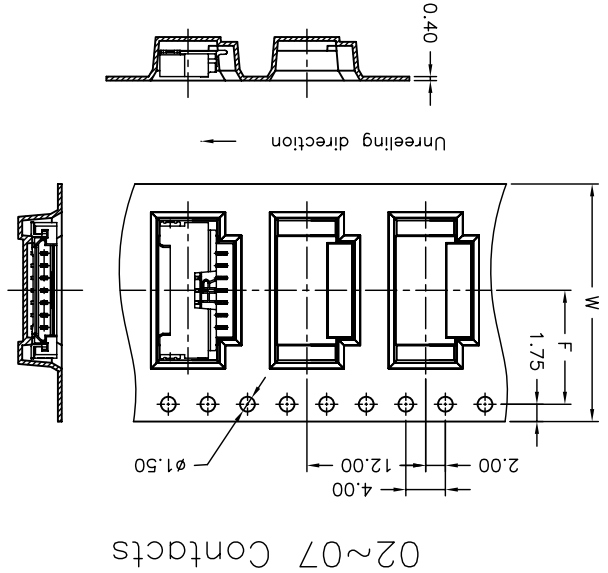

燦達電子工業股份有限公司  
JOINT TECH ELECTRONIC IND. CO., LTD.

## X-ON Electronics

Largest Supplier of Electrical and Electronic Components

*Click to view similar products for [Headers & Wire Housings](#) category:*

*Click to view products by [Joint Tech](#) manufacturer:*

Other Similar products are found below :

[95000-104TRLF](#) [10135584-644402LF](#) [DF62W-EP2022PCA](#) [95000-106TRLF](#) [DF62W-2022SCA](#) [DF62W-EP2022PC](#) [2203348](#) [DF62W-2022SC](#) [1084018](#) [1029039](#) [1084017](#) [802-10-012-10-002000](#) [1112640](#) [1112639](#) [891-007-9SS-BST1T](#) [000-34000](#) [0008550134](#) [0009482033](#) [0009507031](#) [57102-F02-18ULF](#) [57102-S06-03LF](#) [57202-S52-04LF](#) [PCN6-15S-2.5E](#) [0039019024](#) [58102-G61-06LF](#) [582553-1](#) [0009485154](#) [0009508121](#) [0022285053](#) [0050291907](#) [018731A](#) [LY20-4P-DT1-P1E-BR](#) [02.125.8002.8](#) [60101931](#) [60598-1 \(Cut Strip\)](#) [M1625-3R/100](#) [61062-3](#) [61082-181009](#) [CSU011177004](#) [636-1427](#) [638009-1](#) [641938-9](#) [641991-4](#) [644168-1](#) [644827-2](#) [647662-1](#) [65039-019ELF](#) [65692-001LF](#) [65781-018](#) [65781-047](#)