

|      |    |             |               |      |            |      |    |           |  |            |
|------|----|-------------|---------------|------|------------|------|----|-----------|--|------------|
| REV. | B3 | DESCRIPTION | EN10011900040 | DATE | 2011.06.08 | NAME | 陈敏 | X.XX±0.15 | ANGLE  |            |
|      |    |             |               |      |            |      |    | X.XX±0.05 |  |            |
|      |    |             |               |      |            |      |    |           | GENERAL TOLERANCE  |            |
|      |    |             |               |      |            |      |    |           | 2004.10.12   | 2004.10.12 |
|      |    |             |               |      |            |      |    |           | 修正一  |            |
|      |    |             |               |      |            |      |    |           | APPROVED BY  |            |
|      |    |             |               |      |            |      |    |           | DRAWN BY   |            |
|      |    |             |               |      |            |      |    |           | 1 : 1  | 1 of 2     |
|      |    |             |               |      |            |      |    |           | mm   |            |
|      |    |             |               |      |            |      |    |           | SCALE  | SHEET      |
|      |    |             |               |      |            |      |    |           | TITLE:   |            |
|      |    |             |               |      |            |      |    |           |  燦達電子工業股份有限公司<br>JOINT TECH ELECTRONIC IND. CO., LTD. |            |
|      |    |             |               |      |            |      |    |           | 1.25mm PITCH<br>90° WAFER-SMT TYPE,<br>ULTRA LOW PROFILE,<br>WITHOUT BOSS  |            |
|      |    |             |               |      |            |      |    |           | DRAW NO.: A1253WR-S-XP   |            |
|      |    |             |               |      |            |      |    |           | REV. B3  |            |

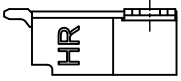

P.C.B. LAYOUT

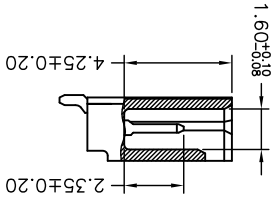
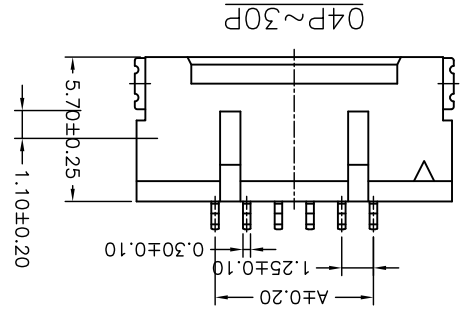
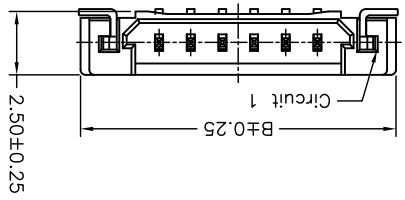
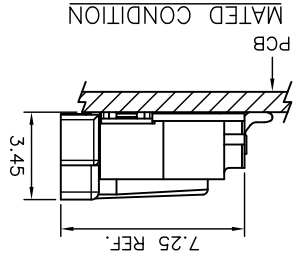
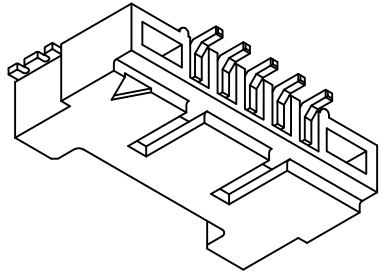
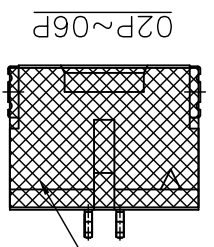
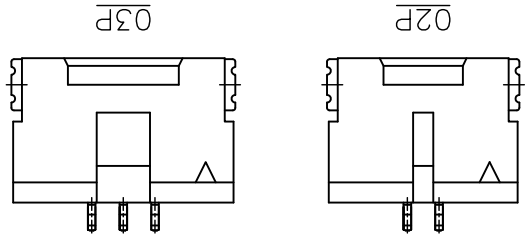
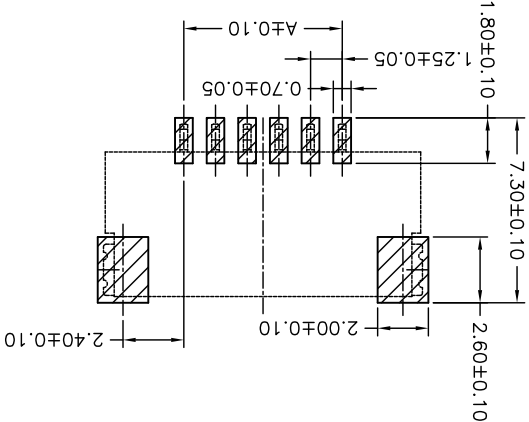

KAPTON TAPE  
(FOR PICK AND  
PLACE SYSTEMS)

| Circuit | Dimensions |       | Circuit    | Dimensions |       |
|---------|------------|-------|------------|------------|-------|
|         | A          | B     |            | A          | B     |
| 10P     | 11.25      | 17.45 | 30P        | 36.25      | 42.45 |
| 09P     | 10.00      | 16.20 | 25P        | 30.00      | 36.20 |
| 08P     | 8.75       | 14.95 | 21P        | 24.00      | 31.20 |
| 07P     | 7.50       | 13.70 | 20P        | 23.75      | 29.95 |
| 06P     | 6.25       | 12.45 | 15P        | 17.50      | 23.70 |
| 05P     | 5.00       | 11.20 | 14P        | 16.25      | 22.45 |
| 04P     | 3.75       | 9.95  | 13P        | 15.00      | 21.20 |
| 03P     | 2.50       | 8.70  | 12P        | 13.75      | 19.95 |
| 02P     | 1.25       | 7.45  | 11P        | 12.50      | 18.70 |
|         |            |       | No. A      | No. B      |       |
|         |            |       | Dimensions |            |       |

**SPECIFICATIONS**  
 Current Rating: 1A AC,DC  
 Voltage Rating: 150V AC,DC  
 Temperature Range: -25°C ~ +85°C  
 Contact Resistance: 30mΩ Max.  
 Insulation Resistance: 500MΩ Min.  
 Withstanding Voltage: 500V AC/minute  
 Pin Material: Brass  
 Solder Tabs: Brass  
 Material: Nylon 6T,UL94V-0  
 Color: Natural(Beige)

**P/N LEGEND**  
 A1253 WR-S-XP XXX  
 ① Series No.  
 ② Connector type: WR=Right angle  
 ③ Mounting type: S=SMT  
 ④ No. of circuits  
 ⑤ Option code:  
 Blank=Contacts/Matte Tin-plated and  
 Solder tabs/Matte Tin-plated Without Mylar  
 D01=Contacts/Gold-flash and  
 Solder tabs/Gold-flash  
 S01=Contacts/Matte Tin-plated and  
 Solder tabs/Matte Tin-plated With Mylar

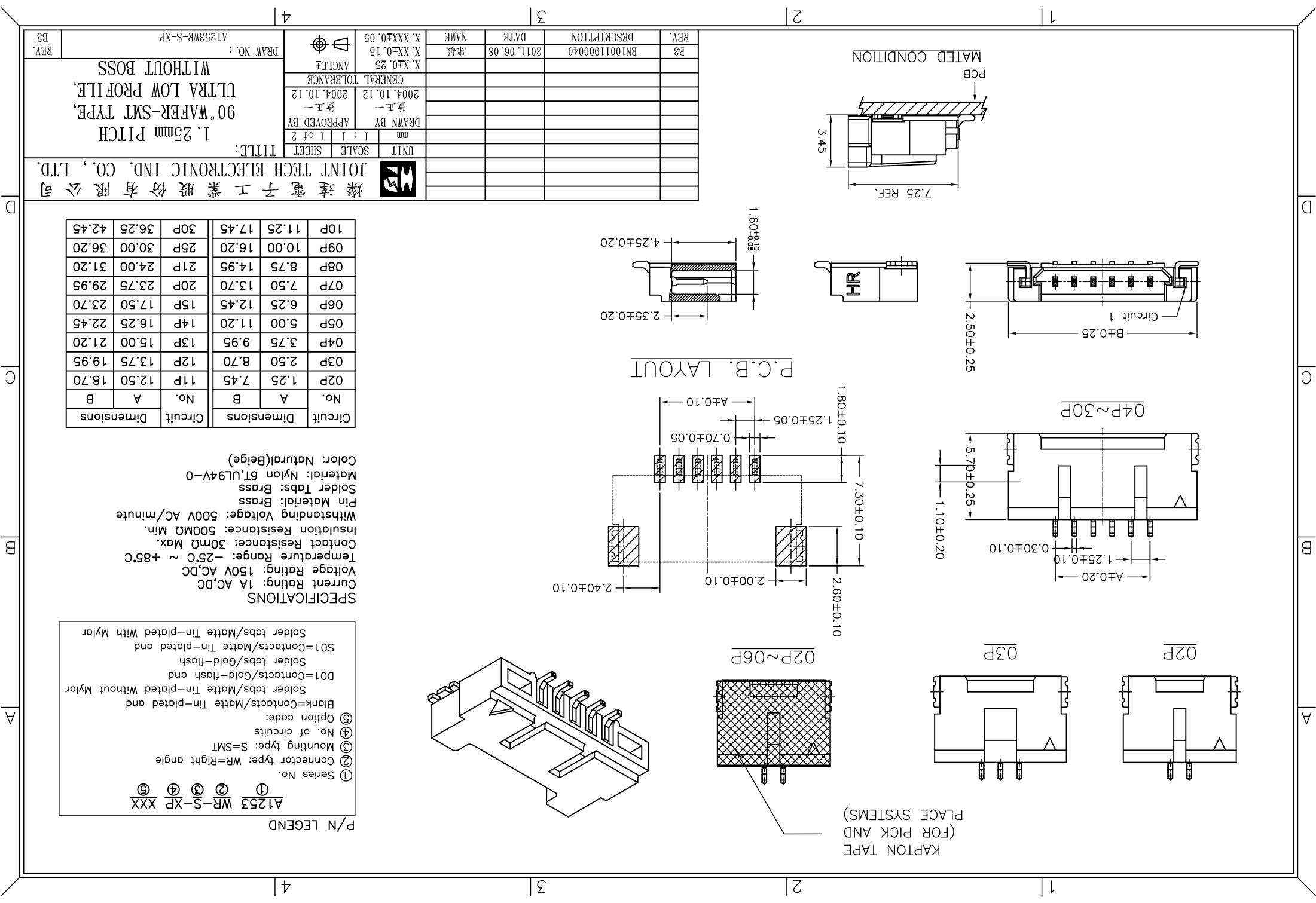

## X-ON Electronics

Largest Supplier of Electrical and Electronic Components

*Click to view similar products for [Headers & Wire Housings](#) category:*

*Click to view products by [Joint Tech](#) manufacturer:*

Other Similar products are found below :

[95000-104TRLF](#) [10135584-644402LF](#) [DF62W-EP2022PCA](#) [95000-106TRLF](#) [DF62W-2022SCA](#) [DF62W-EP2022PC](#) [2203348](#) [DF62W-2022SC](#) [1084018](#) [1029039](#) [1084017](#) [802-10-012-10-002000](#) [1112640](#) [1112639](#) [891-007-9SS-BST1T](#) [000-34000](#) [0008550134](#) [0009482033](#) [0009507031](#) [57102-F02-18ULF](#) [57102-S06-03LF](#) [57202-S52-04LF](#) [PCN6-15S-2.5E](#) [0039019024](#) [58102-G61-06LF](#) [582553-1](#) [0009485154](#) [0009508121](#) [0022285053](#) [0050291907](#) [018731A](#) [LY20-4P-DT1-P1E-BR](#) [02.125.8002.8](#) [60101931](#) [60598-1 \(Cut Strip\)](#) [M1625-3R/100](#) [61062-3](#) [61082-181009](#) [CSU011177004](#) [636-1427](#) [638009-1](#) [641938-9](#) [641991-4](#) [644168-1](#) [644827-2](#) [647662-1](#) [65039-019ELF](#) [65692-001LF](#) [65781-018](#) [65781-047](#)