

REV.	B3	DESCRIPTION	EN10011900040	DATE	2011.06.08	NAME	陈敏	X.XX±0.15	ANGLE	
								X.XX±0.05		
									GENERAL TOLERANCE	
									2004.10.12	2004.10.12
									修正一	
									APPROVED BY	
									DRAWN BY	
									1 : 1	1 of 2
									mm	
									SCALE	SHEET

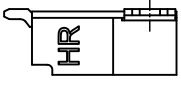
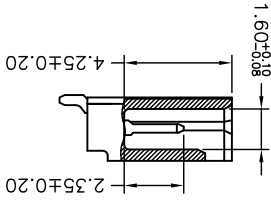
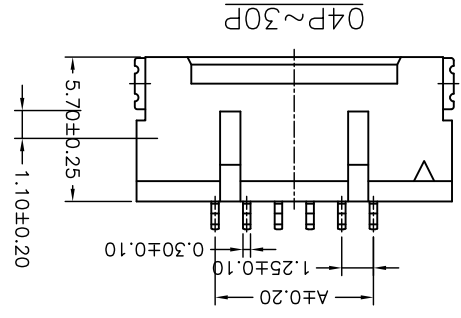
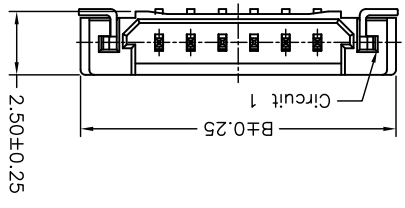
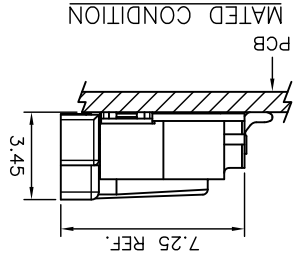

**燦達電子工業股份有限公司**  
**JOINT TECH ELECTRONIC IND. CO., LTD.**

**1.25mm PITCH**  
**90° WAFER-SMT TYPE,**  
**ULTRA LOW PROFILE,**  
**WITHOUT BOSS**

REV. B3

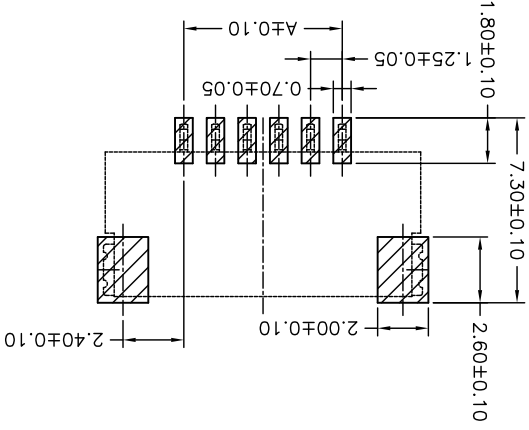

P.C.B. LAYOUT



Circuit	Dimensions		Circuit	Dimensions	
	A	B		No.	Dimensions
10P	11.25	17.45	30P	36.25	42.45
09P	10.00	16.20	25P	30.00	36.20
08P	8.75	14.95	21P	24.00	31.20
07P	7.50	13.70	20P	23.75	29.95
06P	6.25	12.45	15P	17.50	23.70
05P	5.00	11.20	14P	16.25	22.45
04P	3.75	9.95	13P	15.00	21.20
03P	2.50	8.70	12P	13.75	19.95
02P	1.25	7.45	11P	12.50	18.70
			A	B	

**SPECIFICATIONS**  
 Current Rating: 1A AC,DC  
 Voltage Rating: 150V AC,DC  
 Temperature Range: -25°C ~ +85°C  
 Contact Resistance: 30mΩ Max.  
 Insulation Resistance: 500MΩ Min.  
 Withstanding Voltage: 500V AC/minute  
 Pin Material: Brass  
 Solder Tabs: Brass  
 Material: Nylon 6T,UL94V-0  
 Color: Natural(Beige)

**P/N LEGEND**  
 A1253 WR-S-XP XXX  
 ① Series No.  
 ② Connector type: WR=Right angle  
 ③ Mounting type: S=SMT  
 ④ No. of circuits  
 ⑤ Option code:  
 Blank=Contacts/Matte Tin-plated and  
 Solder tabs/Matte Tin-plated Without Mylar  
 D01=Contacts/Gold-flash and  
 Solder tabs/Gold-flash  
 S01=Contacts/Matte Tin-plated and  
 Solder tabs/Matte Tin-plated With Mylar

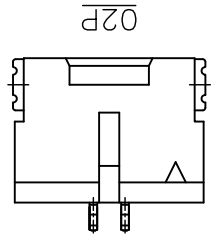
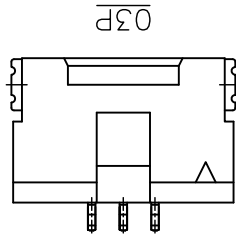
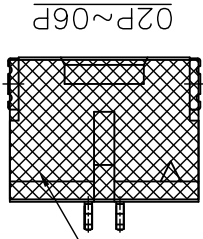
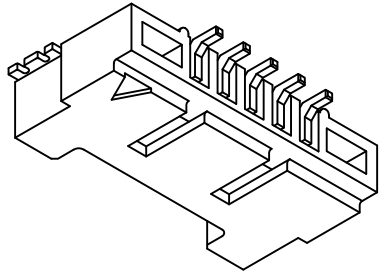

KAPTON TAPE  
 (FOR PICK AND  
 PLACE SYSTEMS)

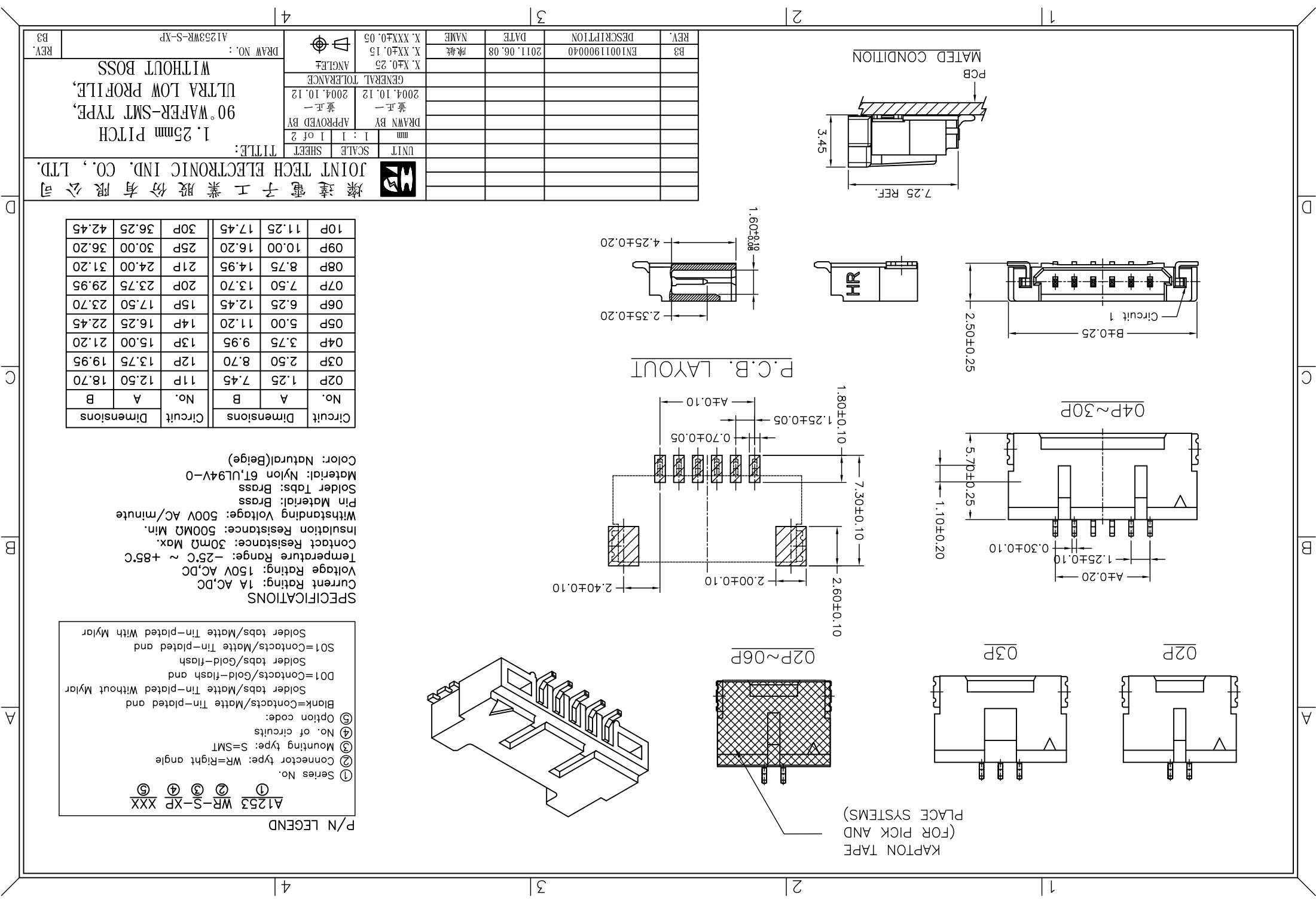

## X-ON Electronics

Largest Supplier of Electrical and Electronic Components

*Click to view similar products for [Headers & Wire Housings](#) category:*

*Click to view products by [Joint Tech](#) manufacturer:*

Other Similar products are found below :

[95000-104TRLF](#) [10135584-644402LF](#) [DF62W-EP2022PCA](#) [95000-106TRLF](#) [DF62W-2022SCA](#) [DF62W-EP2022PC](#) [2203348](#) [DF62W-2022SC](#) [1084018](#) [1029039](#) [1084017](#) [802-10-012-10-002000](#) [1112640](#) [1112639](#) [891-007-9SS-BST1T](#) [000-34000](#) [0008550134](#) [0009482033](#) [0009507031](#) [57102-F02-18ULF](#) [57102-S06-03LF](#) [57202-S52-04LF](#) [PCN6-15S-2.5E](#) [0039019024](#) [58102-G61-06LF](#) [582553-1](#) [0009485154](#) [0009508121](#) [0022285053](#) [0050291907](#) [018731A](#) [LY20-4P-DT1-P1E-BR](#) [02.125.8002.8](#) [60101931](#) [60598-1 \(Cut Strip\)](#) [M1625-3R/100](#) [61062-3](#) [61082-181009](#) [CSU011177004](#) [636-1427](#) [638009-1](#) [641938-9](#) [641991-4](#) [644168-1](#) [644827-2](#) [647662-1](#) [65039-019ELF](#) [65692-001LF](#) [65781-018](#) [65781-047](#)