

P.C.B LAYOUT (TOP VIEW)

P/N LEGEND

A1254 WR-S-XP N 6 X XX X XX X
 ① ② ③ ④ ⑤ ⑥ ⑦ ⑧ ⑨ ⑩ ⑪

- ① Series No.
- ② Connector type: WR=Right angle
- ③ Mounting type: S=SMT without post
- ④ No. of circuits
- ⑤ N=Halogen Free
- ⑥ Material: 6=Nylon 6T;
- ⑦ Color: B=Natural(Black); N=Natural(Beige)
- ⑧ Plating code for contacts:
T1=Matte Tin-plated; G2=Gold-plated 3u"
G1=Gold-flash 1u"
- ⑨ Plating code for solder tabs:
T=Matte Tin-plated; G=Gold-flash
- ⑩ Option code: 00=Standard
S2=For Wistron Tape & Reel
- ⑪ Packing code:
L=Tape & Reel(With Mylar)
R=Tape & Reel(Without Cap or Mylar)

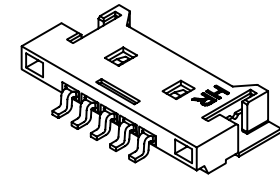

SPECIFICATIONS

Current Rating: 1A AC,DC
 Voltage Rating: 125V AC,DC
 Temperature Range: -25°C ~ +85°C
 Contact Resistance: 20mΩ Max.
 Insulation Resistance: 100MΩ Min.
 Withstanding Voltage: 500V AC/minute
 Pin Material: Brass
 Solder Tabs: Brass

Circuit No.	Dimensions				
	A	B	C	D	E
02P	1.25	7.65	8.07	---	2.90
03P	2.50	8.90	9.32	---	4.15
04P	3.75	10.15	10.57	2.50	5.40
05P	5.00	11.40	11.82	3.75	6.65
06P	6.25	12.65	13.07	5.00	7.90
07P	7.50	13.90	14.32	6.25	9.15
08P	8.75	15.15	15.57	7.50	10.40
09P	10.00	16.40	16.82	8.75	11.65
10P	11.25	17.65	18.07	10.00	12.90
11P	12.50	18.90	19.32	11.25	14.15
12P	13.75	20.15	20.57	12.50	15.40
14P	16.25	22.65	23.07	15.00	17.90
15P	17.50	23.90	24.32	16.25	19.15
16P	18.75	25.15	25.57	17.50	20.40
20P	23.75	30.15	30.57	22.50	25.40
30P	36.25	42.65	43.07	22.50	37.90

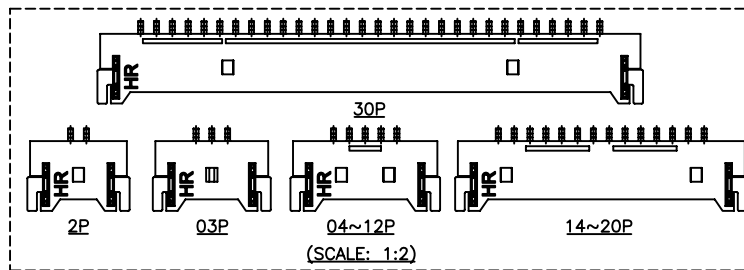

(SCALE: 1:2)

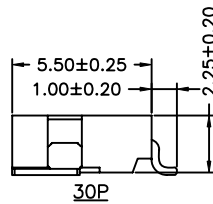
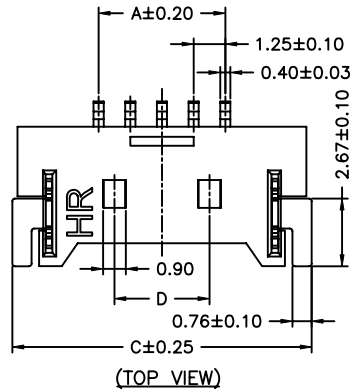

30P

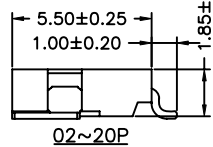
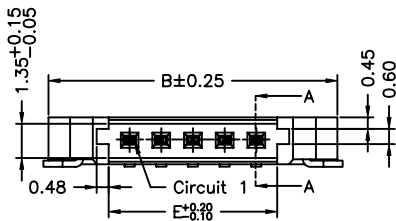

02~20P

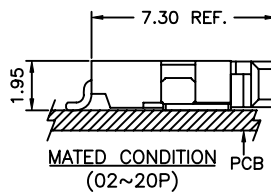

MATED CONDITION (02~20P)

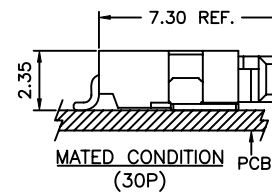

MATED CONDITION (30P)

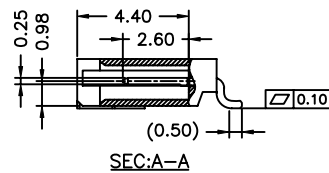
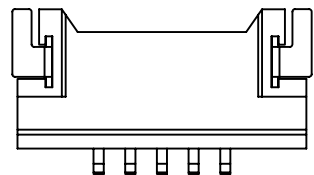

SEC:A-A

B3	EN1701160001	2017. 01. 16	賴永強	燦達電子工業股份有限公司 JOINT TECH ELECTRONIC IND. CO., LTD.	UNIT	SCALE	SHEET	TITLE: 1.25mm PITCH 90° WAFER-SMT TYPE, ULTRA LOW PROFILE
B2	EN1505140001	2015. 05. 14	黃培軍		mm	1 : 1	1 of 3	
B1	EN1504210004	2015. 04. 21	劉建芳		DRAWN BY	APPROVED BY		
B0	EN1407080001	2014. 06. 19	黃培軍		陳敏	董正一		
A5	EN1403190003	2014. 03. 19	唐騰鳳		2010. 02. 08	2010. 02. 08		
A4	EN1306280216	2013. 07. 01	陳錦展		GENERAL TOLERANCE			
A3	EN1306170197	2013. 06. 17	陳錦展		X. X±0.25	ANGLE±		
A2	EN1305080146	2013. 05. 08	陳錦展		X. XX±0.15	▽		
A1	EN1211280383	2012. 11. 28	陳錦展		X. XXX±0.05	DRAW NO. :		
A0	NEW RELEASE	2010. 02. 08	陳敏		A1254WR-S-XPXXXXXXX			
REV.	DESCRIPTION	DATE	NAME				REV. B3	



02~09 Contacts

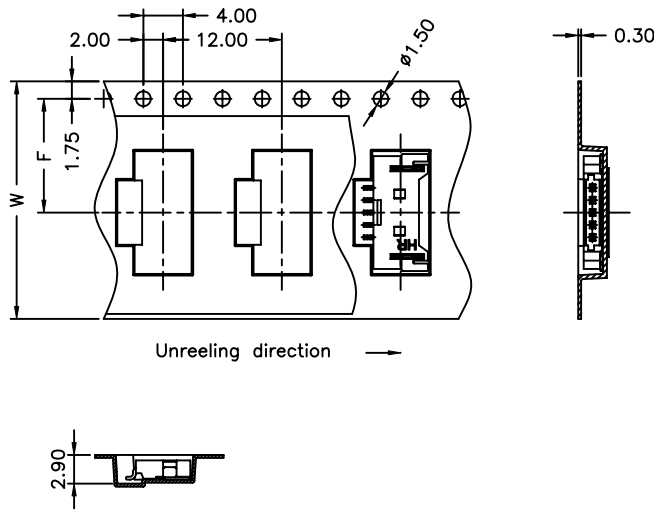

10~30 Contacts

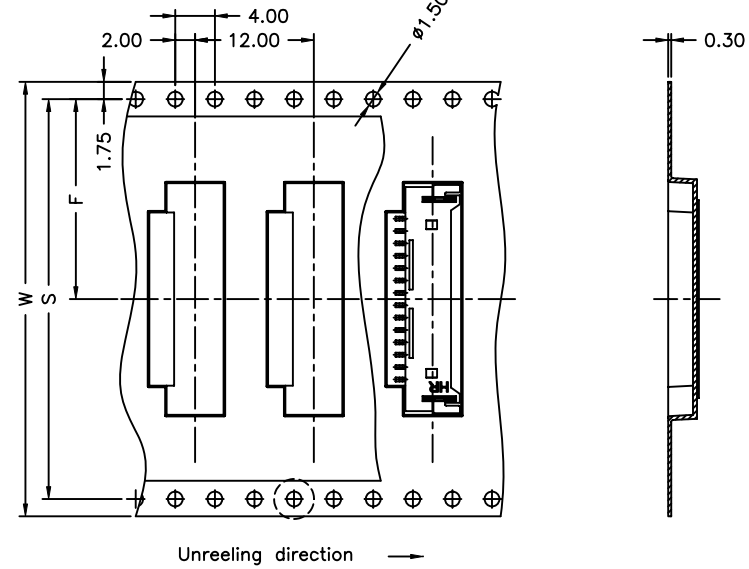

00包裝規格示意圖

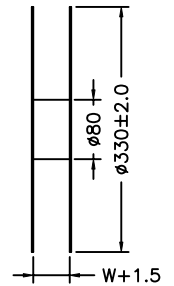
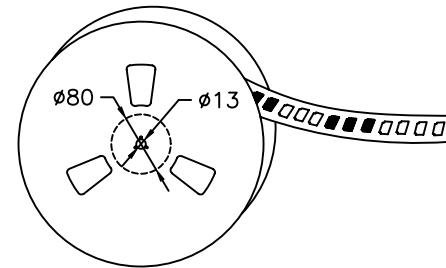
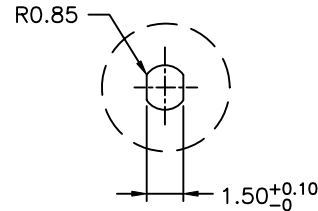
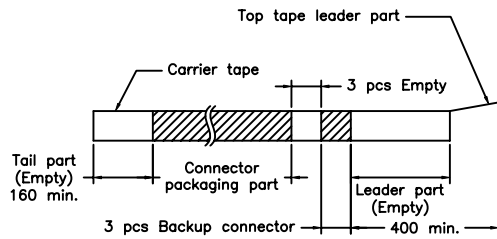

Number of Contacts	W±0.3	F±0.1	S±0.1	Q'ty/Reel
02P	16	7.50		1,500
03P	24	7.50		1,500
04P	24	11.50		1,500
05P	24	11.50		1,500
06P	24	11.50		1,500
07P	24	11.50		1,500
08P	24	11.50		1,500
09P	24	11.50		1,500
10P	32	14.20	28.40	1,500
11P	32	14.20	28.40	1,500
12P	32	14.20	28.40	1,500
14P	44	20.20	40.40	1,500
15P	44	20.20	40.40	1,500
16P	44	20.20	40.40	1,500
20P	44	20.20	40.40	1,500
30P	56	26.20	52.40	1,500

NOTE:
Material: Transparent
Anti-static Polystyrene.

REV.	DESCRIPTION	DATE	NAME	UNIT	SCALE	SHEET	TITLE:	DRAW NO.:	REV.
B3	EN1701160001	2017. 01. 16	賴永強	mm	1 : 1	2 of 3	燦達電子工業股份有限公司 JOINT TECH ELECTRONIC IND. CO., LTD. 1.25mm PITCH 90° WAFER-SMT TYPE, TAPING SPEC.	A1254WR-S-XPXXXXXXX	B3
B2	EN1505140001	2015. 05. 14	黃培軍						
B1	EN1504210004	2015. 04. 21	劉建芳						
B0	EN1407080001	2014. 06. 19	黃培軍						
A5	EN1403190003	2014. 03. 19	唐騰鳳						
A4	EN1306280216	2013. 07. 01	陳錦展						
A3	EN1306170197	2013. 06. 17	陳錦展						
A2	EN1305080146	2013. 05. 08	陳錦展						
A1	EN1211280383	2012. 11. 28	陳錦展						
A0	NEW RELEASE	2010. 02. 08	陳敏						
REV.	DESCRIPTION	DATE	NAME	X. X±0. 25	ANGLE±				



03 Contacts

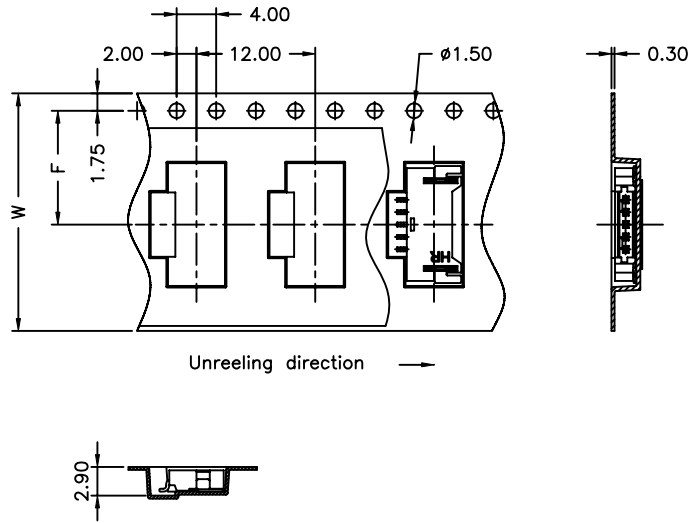

08~09 Contacts

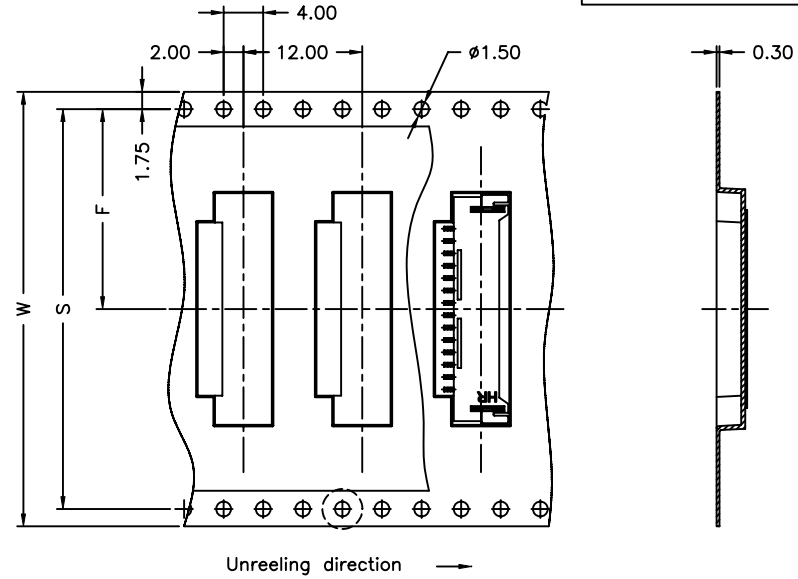

S2載帶寬不同包裝規格示意圖

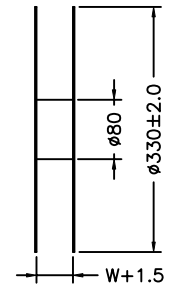
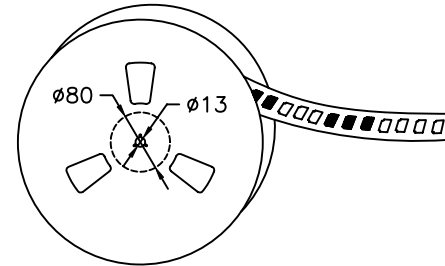
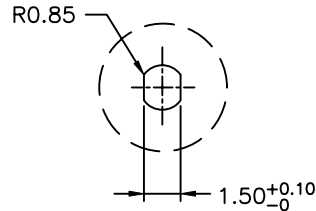
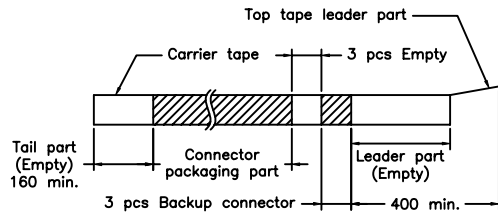

NOTE:
Material:Transparent
Anti-static Polystyrene.

Number of Contacts	W±0.3	F±0.1	S±0.1	Q'ty/Reel
03P	16	7.50		1,500
08P	32	14.20	28.40	1,500
09P	32	14.20	28.40	1,500

				燦達電子工業股份有限公司 JOINT TECH ELECTRONIC IND. CO., LTD.	
UNIT		SCALE	SHEET		TITLE:
mm		1 : 1	3 of 3		1.25mm PITCH 90° WAFER-SMT TYPE, TAPING SPEC.
DRAWN BY		APPROVED BY		DRAW NO. :	
陳錦展		吳國維			
2011.06.02		2011.06.02		A1254WR-S-XPNXXXXXXXXX	
GENERAL TOLERANCE					
B3	EN1701160001	2017.01.16	賴永強	X.X±0.25	ANGLE±
B2	EN1505140001	2015.05.14	黃培軍	X.XX±0.15	
REV.	DESCRIPTION	DATE	NAME	X.XXX±0.05	

X-ON Electronics

Largest Supplier of Electrical and Electronic Components

Click to view similar products for [Headers & Wire Housings](#) category:

Click to view products by [Joint Tech](#) manufacturer:

Other Similar products are found below :

[57102-F02-18ULF](#) [58102-G61-06LF](#) [0009485154](#) [009176003701906](#) [0050291907](#) [02.125.8002.8](#) [609-3404](#) [61062-3](#) [622-0430](#) [622-3653LF](#)
[63453-116](#) [636-1030](#) [636-1427](#) [636-3427](#) [636-4007](#) [641938-9](#) [65495-038](#) [65692-001LF](#) [65781-018](#) [65781-047](#) [65817-010LF](#) [65817-015LF](#)
[66207-023LF](#) [67016-026LF](#) [67095-007LF](#) [68631-112](#) [68645-018](#) [68648-049](#) [699319-000](#) [70.362.1628.0](#) [70-4210](#) [70-4226B](#) [70-4853B](#) [707-](#)
[5020](#) [707-5028](#) [71.350.2428.0](#) [71961-016LF](#) [733-134](#) [754199-000](#) [760-3052](#) [787-8014-00](#) [FCN-367T-T012/H](#) [80.063.4001.1](#) [800-90-001-](#)
[10-001000](#) [800-90-010-10-002000](#) [801-43-002-10-013000](#) [801-43-006-10-002000](#) [803-41-018-10-001000](#) [803-43-014-20-001000](#)
[803-43-024-10-001000](#)