

P/N LEGEND

- | A2001 WV-XP XXX | | | |
|--|---|---|---|
| ① | ② | ③ | ④ |
| ① Series No. | | | |
| ② Connector type: WV=Vertical | | | |
| ③ No. of circuits | | | |
| ④ Option code: | | | |
| 1=Nylon 66-V0, Color: White, Tin-plated | | | |
| 1BK=Nylon 66-V0, Color: Black, Tin-plated | | | |
| 1BL=Nylon 66-V0, Color: Blue(660C), Tin-plated | | | |
| 1GR=Nylon 66-V0, Color: Green(347C), Tin-plated | | | |
| 146=Nylon 46-V0, Color: Beige, Tin-plated | | | |
| 011=Nylon 46-V0, Color: Black, Tin-plated | | | |
| 16T=Nylon 6T-V0, Color: Beige, Tin-plated | | | |
| S1=Nylon 66+15%GF-V0, Color: White, Tin-plated | | | |
| 1NF=Nylon 66-V2,NO flame,Color: Natural,Tin-plated | | | |

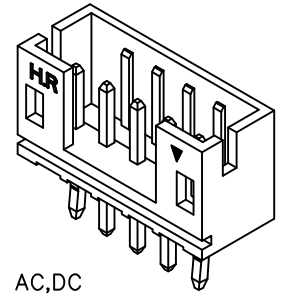

SPECIFICATIONS
 Current Rating: 2A AC,DC
 Voltage Rating: 100V AC,DC
 Temperature Range: -25°C ~ +85°C
 Contact Resistance: 10mΩ Max.
 Insulation Resistance: 1000MΩ Min.
 Withstanding Voltage: 800V AC/minute
 Pin Material: Brass

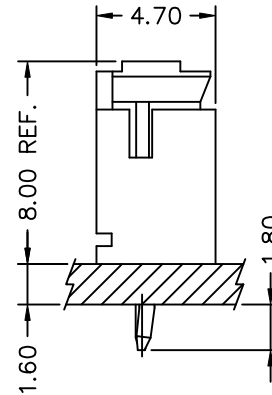
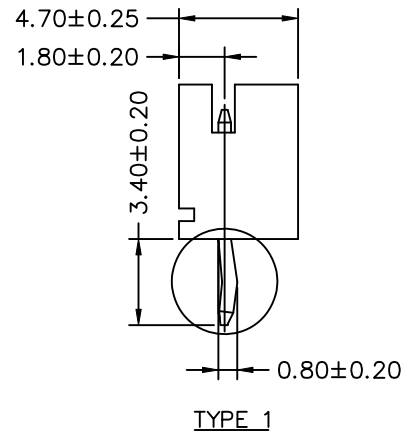
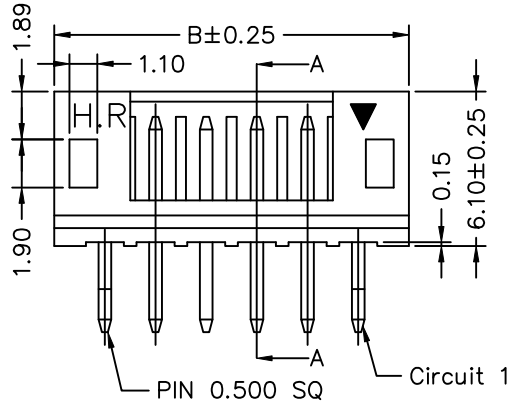

Circuit No.	Dimensions		
	A	B	C
02P	2.00	6.00	4.80
03P	4.00	8.00	6.80
04P	6.00	10.00	8.80
05P	8.00	12.00	10.80
06P	10.00	14.00	12.80
07P	12.00	16.00	14.80
08P	14.00	18.00	16.80
09P	16.00	20.00	18.80
10P	18.00	22.00	20.80
11P	20.00	24.00	22.80
12P	22.00	26.00	24.80
13P	24.00	28.00	26.80
14P	26.00	30.00	28.80
15P	28.00	32.00	30.80
16P	30.00	34.00	32.80
17P	32.00	36.00	34.80
18P	34.00	38.00	36.80

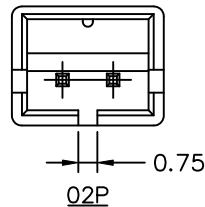
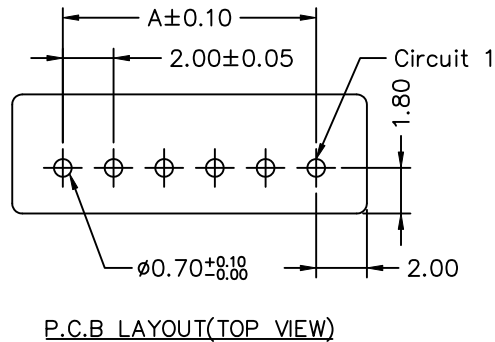

						燦達電子工業股份有限公司 JOINT TECH ELECTRONIC IND. CO., LTD.	
		UNIT	SCALE	SHEET	TITLE:		
		mm	1 : 1	1 of 1	2.00mm PITCH 180° WAFER, TYPE 1		
		DRAWN BY	APPROVED BY				
		李勤	呂長祈				
		2006.07.21	2006.07.21				
B1	取消紅色短料號	2017.04.14	任運宏	GENERAL TOLERANCE			
B0	EN1607250001	2016.06.23	楚新璋				
A5	EN1301220022	2013.01.22	郭木恩	ANGLE±		DRAW NO. :	
A4	EN1211080364	2012.11.13	陳錦展				
REV.	DESCRIPTION	DATE	NAME	X.X±0.25	X.XX±0.15	X.XXX±0.05	A2001WV-XP1

X-ON Electronics

Largest Supplier of Electrical and Electronic Components

Click to view similar products for [Headers & Wire Housings](#) category:

Click to view products by [Joint Tech](#) manufacturer:

Other Similar products are found below :

[57102-F02-18ULF](#) [58102-G61-06LF](#) [582553-1](#) [009176003701906](#) [01.001.5753.1](#) [0050291907](#) [02.125.8002.8](#) [609-3404](#) [61062-3](#)
[CSU011177004](#) [622-0430](#) [622-3653LF](#) [63453-116](#) [636-1030](#) [636-1427](#) [636-3427](#) [636-4007](#) [641938-9](#) [65495-038](#) [65692-001LF](#) [65781-018](#)
[65781-047](#) [65817-010LF](#) [65817-015LF](#) [66207-023LF](#) [67095-007LF](#) [67601157](#) [68631-112](#) [68645-018](#) [699319-000](#) [M90C108951C](#)
[70.362.1628.0](#) [70-4210](#) [70-4226B](#) [70-4853B](#) [707-5028](#) [71.350.2428.0](#) [71961-016LF](#) [733-134](#) [733-162](#) [754199-000](#) [760-3052](#) [80.063.4001.1](#)
[800-90-001-10-001000](#) [800-90-010-10-002000](#) [801-43-002-10-013000](#) [801-43-006-10-002000](#) [803-41-018-10-001000](#) [803-43-024-10-](#)
[001000](#) [803-93-012-10-001000](#)