

① Series No. A2004 WRA-2XNP XXX
 ② Connector type: WRA=Right angle A type
 ③ No. of circuits
 ④ Option code: Blank=Standard

P/N LEGEND

SPECIFICATIONS
 Current Rating: 3A AC,DC
 Voltage Rating: 250V AC,DC
 Temperature Range: -25°C ~ +85°C
 Contact Resistance: 10mΩ Max.
 Insulation Resistance: 1000MΩ Min.
 Withstanding Voltage: 800V AC/minute
 Pin Material: Brass/Gold-flash
 Material: Nylon 6T,UL94V-0
 Color: Natural(Beige)

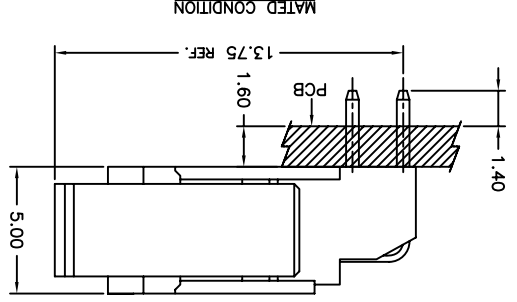
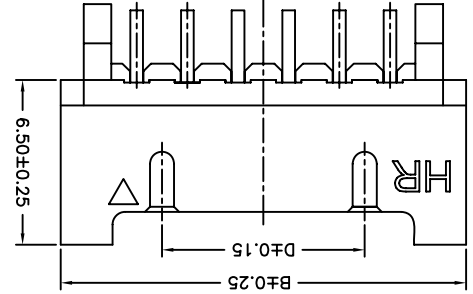
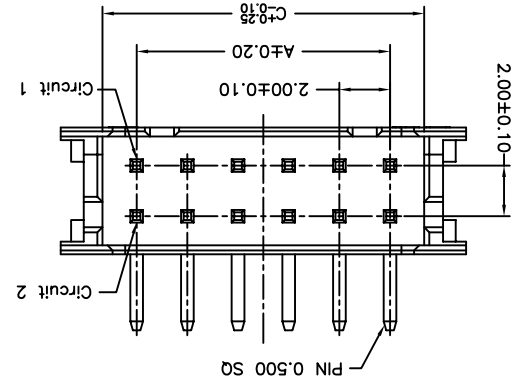
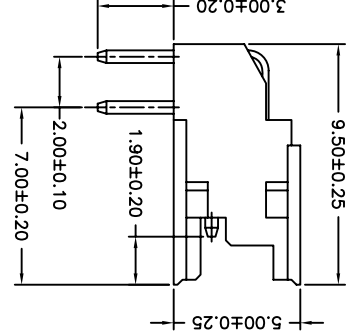
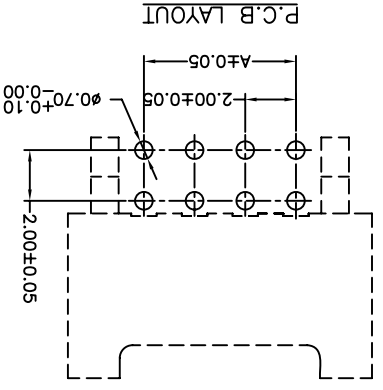
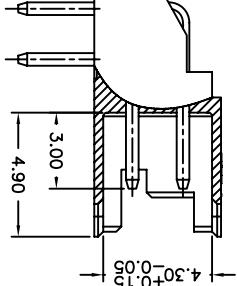
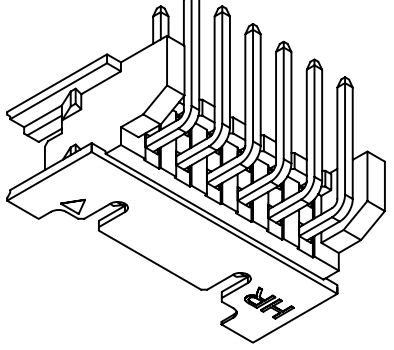

| | | | | | |
|---------|-------------|-----------------|-----------------|------------|-------------------|
| REV. A2 | EN112050511 | DATE 2011.12.05 | NAME 陳錦展 | X.XX±0.05 | ANGLE |
| | | | | X.XX±0.15 | GENERAL TOLERANCE |
| | | | | 2006.10.27 | 2006.10.27 |
| | | | DRAWN BY 歐陽小強 | 2006.10.27 | 2006.10.27 |
| | | | APPROVED BY 姜正一 | 2006.10.27 | 2006.10.27 |
| | | | | 1 | 1 |
| | | | | mm | 1 of 1 |
| | | | | | |
| | | | | UNIT | SCALE |
| | | | | | SHEET |
| | | | | | |

DRAW NO.: A2004WRA-2XNP

REV. A2

TITLE: 90° WAFER-LOCK TYPE 2.00mm PITCH

燦達電子工業股份有限公司
 JOINT TECH ELECTRONIC IND. CO., LTD.

| Circuit | Dimensions | | | | |
|---------|------------|-------|-------|-------|---|
| | No. | A | B | C | D |
| 2X02P | 2.00 | 8.00 | 4.70 | --- | |
| 2X03P | 4.00 | 10.00 | 6.70 | 2.00 | |
| 2X04P | 6.00 | 12.00 | 8.70 | 4.00 | |
| 2X05P | 8.00 | 14.00 | 10.70 | 6.00 | |
| 2X06P | 10.00 | 16.00 | 12.70 | 8.00 | |
| 2X07P | 12.00 | 18.00 | 14.70 | 10.00 | |
| 2X08P | 14.00 | 20.00 | 16.70 | 12.00 | |
| 2X09P | 16.00 | 22.00 | 18.70 | 14.00 | |
| 2X10P | 18.00 | 24.00 | 20.70 | 16.00 | |
| 2X11P | 20.00 | 26.00 | 22.70 | 18.00 | |
| 2X12P | 22.00 | 28.00 | 24.70 | 20.00 | |
| 2X13P | 24.00 | 30.00 | 26.70 | 22.00 | |
| 2X14P | 26.00 | 32.00 | 28.70 | 24.00 | |
| 2X15P | 28.00 | 34.00 | 30.70 | 26.00 | |
| 2X16P | 30.00 | 36.00 | 32.70 | 28.00 | |
| 2X17P | 32.00 | 38.00 | 34.70 | 30.00 | |
| 2X18P | 34.00 | 40.00 | 36.70 | 32.00 | |
| 2X19P | 36.00 | 42.00 | 38.70 | 34.00 | |
| 2X20P | 38.00 | 44.00 | 40.70 | 36.00 | |

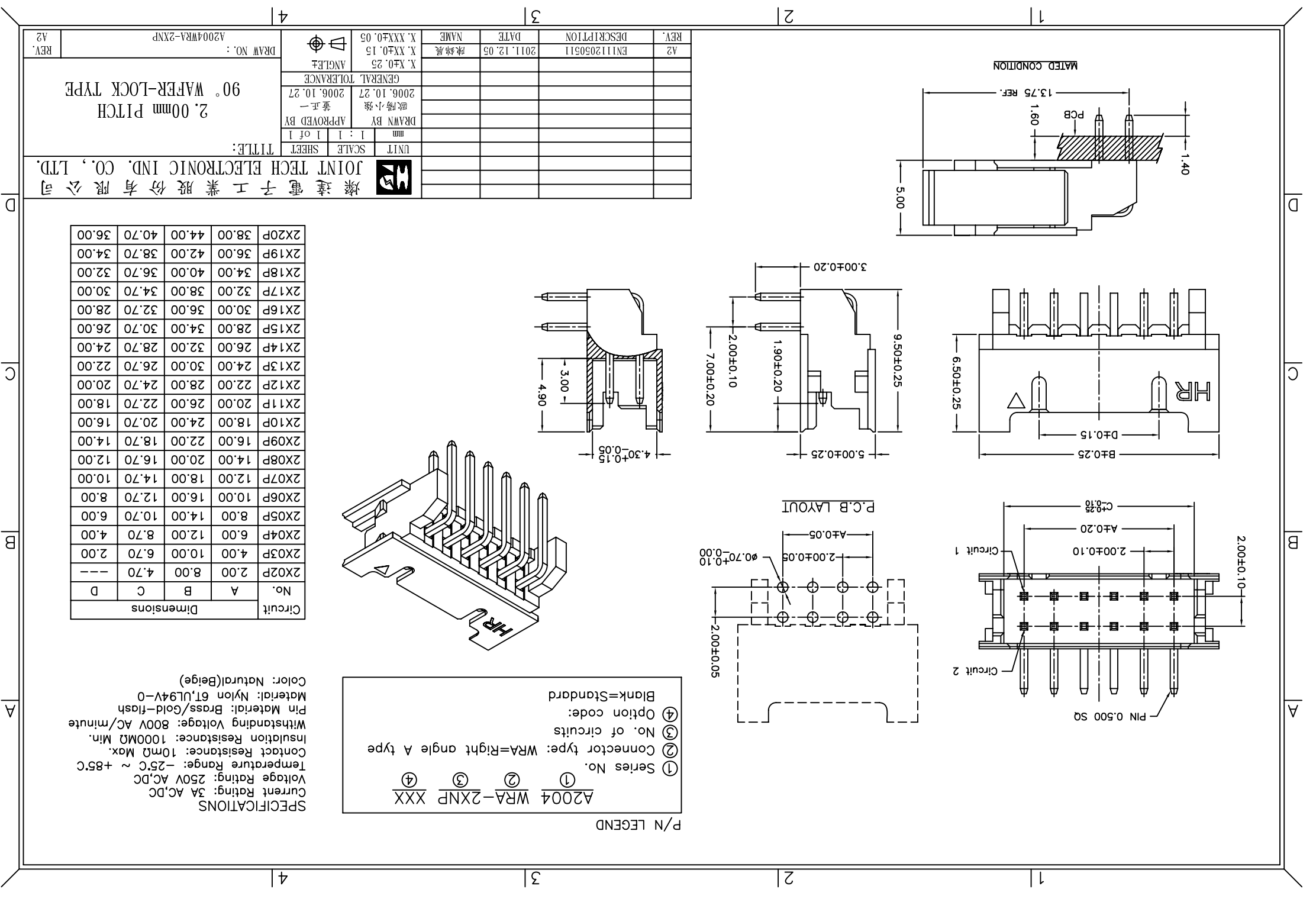

X-ON Electronics

Largest Supplier of Electrical and Electronic Components

Click to view similar products for [Headers & Wire Housings](#) category:

Click to view products by [Joint Tech](#) manufacturer:

Other Similar products are found below :

[95000-104TRLF](#) [10135584-644402LF](#) [DF62W-EP2022PCA](#) [95000-106TRLF](#) [DF62W-2022SCA](#) [DF62W-EP2022PC](#) [2203348](#) [DF62W-2022SC](#) [1084018](#) [1029039](#) [1084017](#) [802-10-012-10-002000](#) [1112640](#) [1112639](#) [891-007-9SS-BST1T](#) [000-34000](#) [0008550134](#) [0009482033](#) [0009507031](#) [57102-F02-18ULF](#) [57102-S06-03LF](#) [57202-S52-04LF](#) [PCN6-15S-2.5E](#) [0039019024](#) [58102-G61-06LF](#) [582553-1](#) [0009485154](#) [0009508121](#) [0022285053](#) [0050291907](#) [018731A](#) [LY20-4P-DT1-P1E-BR](#) [02.125.8002.8](#) [60101931](#) [60598-1 \(Cut Strip\)](#) [M1625-3R/100](#) [61062-3](#) [61082-181009](#) [CSU011177004](#) [636-1427](#) [638009-1](#) [641938-9](#) [641991-4](#) [644168-1](#) [644827-2](#) [647662-1](#) [65039-019ELF](#) [65692-001LF](#) [65781-018](#) [65781-047](#)