

1 |

2 |

3 |

4 |

P/N LEGEND

A2004	WRB	-2XNP	R	0	X	T1	N	XX	B
①	②	③	④	⑤	⑥	⑦	⑧	⑨	⑩

① Series No.
 ② Connector type: WRB=Right angle B Type
 ③ No. of circuits
 ④ R=Rohs
 ⑤ Material: 0=Nylon 66-V0
 ⑥ Color: R=Red(186C); L=Blue(287C)
 ⑦ Plating code for contacts: T1=Tin-plated
 ⑧ Plating code: N=Non-plating
 ⑨ Option code:
 00=Dim. F:3.00mm
 Y1=Dim. F:2.40mm
 ⑩ Packing code: B=Tray

SPECIFICATIONS
 Current Rating: 3A AC,DC
 Voltage Rating: 250V AC,DC
 Temperature Range: -25°C ~ +85°C
 Contact Resistance: 10mΩ Max.
 Insulation Resistance: 1000MΩ Min.
 Withstanding Voltage: 800V AC/minute
 Pin Material: Brass/Tin-plated
 Material: Nylon 66,UL94V-0

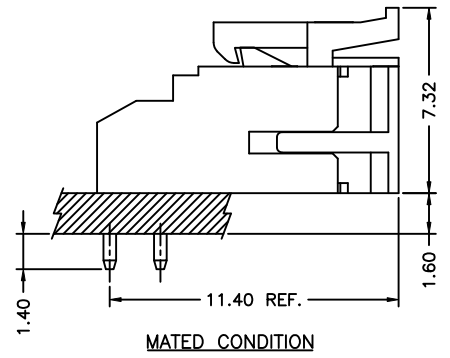
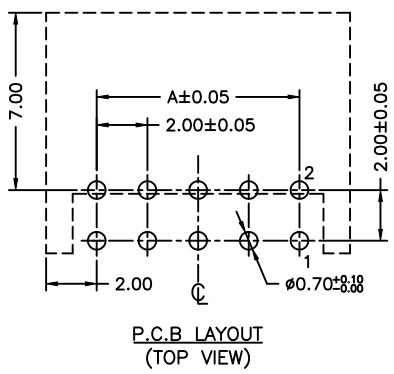
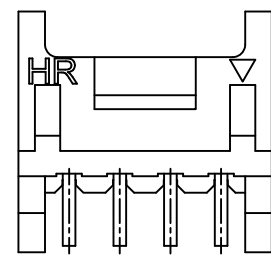
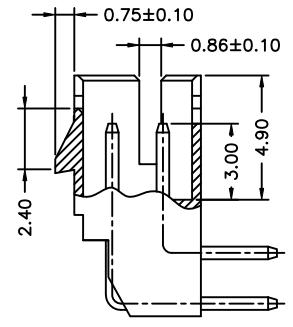
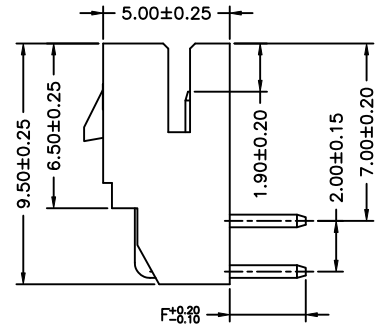
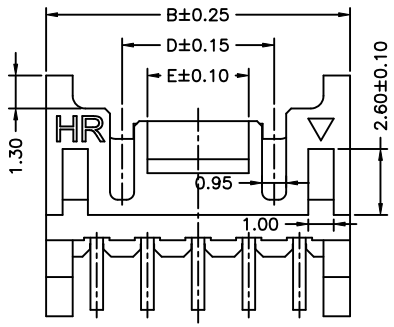
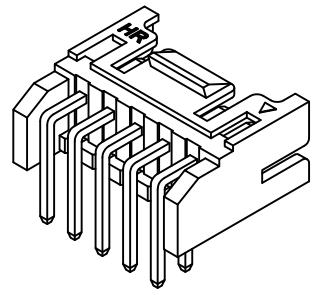
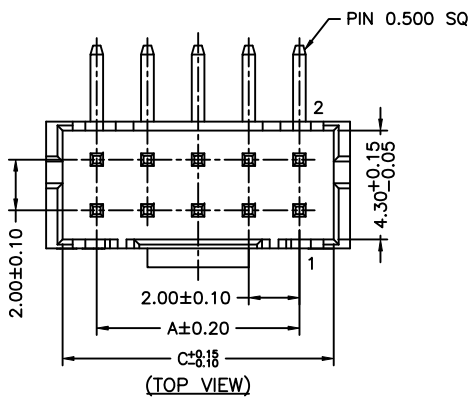

Circuit No.	Dimensions				
	A	B	C	D	E
2X02P	2.00	6.00	4.70	---	1.50
2X03P	4.00	8.00	6.70	---	3.00
2X04P	6.00	10.00	8.70	---	4.00
2X05P	8.00	12.00	10.70	6.00	4.00
2X06P	10.00	14.00	12.70	8.00	4.00
2X07P	12.00	16.00	14.70	10.00	5.00
2X08P	14.00	18.00	16.70	12.00	5.00
2X09P	16.00	20.00	18.70	14.00	5.00
2X10P	18.00	22.00	20.70	16.00	5.00
2X11P	20.00	24.00	22.70	18.00	5.00
2X12P	22.00	26.00	24.70	20.00	5.00
2X13P	24.00	28.00	26.70	22.00	5.00
2X14P	26.00	30.00	28.70	24.00	5.00
2X15P	28.00	32.00	30.70	26.00	5.00
2X16P	30.00	34.00	32.70	28.00	5.00
2X17P	32.00	36.00	34.70	30.00	5.00
2X18P	34.00	38.00	36.70	32.00	5.00
2X19P	36.00	40.00	38.70	34.00	5.00
2X20P	38.00	42.00	40.70	36.00	5.00
2X21P	40.00	44.00	42.70	38.00	5.00
2X22P	42.00	46.00	44.70	40.00	5.00



燦達電子工業股份有限公司
 JOINT TECH ELECTRONIC IND. CO., LTD.

UNIT	SCALE	SHEET	TITLE:
mm	1 : 1	1 of 1	
DRAWN BY	APPROVED BY		2.00mm PITCH 90° WAFER
劉建芳 2015.06.26	陳彥兆 2015.06.26		
GENERAL TOLERANCE			DRAW NO. : A2004WRB-2XNPRXXXXXXXXX
X. X±0.25	ANGLE±		
X. XX±0.15	▽		REV. AO
X. XXX±0.05	⊕		
AO	NEW RELEASE	2015.06.26	劉建芳
REV.	DESCRIPTION	DATE	NAME

1 |

2 |

3 |

4 |

X-ON Electronics

Largest Supplier of Electrical and Electronic Components

Click to view similar products for [Headers & Wire Housings](#) category:

Click to view products by [Joint Tech](#) manufacturer:

Other Similar products are found below :

[0015917161](#) [0022155065](#) [57102-F02-18ULF](#) [58102-G61-06LF](#) [582553-1](#) [01.001.5753.1](#) [0050291907](#) [02.125.8002.8](#) [609-3404](#) [61062-3](#)
[CSU011177004](#) [622-0430](#) [622-3653LF](#) [63453-116](#) [636-1030](#) [636-1427](#) [636-3427](#) [636-4007](#) [641938-9](#) [65495-038](#) [65692-001LF](#) [65781-018](#)
[65781-047](#) [65817-010LF](#) [65817-015LF](#) [67095-007LF](#) [67601157](#) [68631-112](#) [68645-018](#) [699319-000](#) [70.362.1628.0](#) [70-4210](#) [70-4226B](#) [70-](#)
[4853B](#) [71.350.2428.0](#) [733-134](#) [733-162](#) [760-3052](#) [MHR-64-VUAL](#) [80.063.4001.1](#) [800-90-001-10-001000](#) [801-43-002-10-013000](#)
[801-43-006-10-002000](#) [803-43-024-10-001000](#) [803-93-012-10-001000](#) [8-1437020-4](#) [819-22-004-30-001101](#) [820-22-006-30-001101](#)
[820-22-008-30-001101](#) [821-22-002-10-001101](#)