

Ordering Information:

A2100WV-XP *
1 2

- 1-Part No.
- 2-Style:
 - 1-Type 1
 - 2-Type 2
 - 3-Type 3

SPECIFICATIONS

Current Rating: 3A AC,DC
 Voltage Rating: 300V AC,DC
 Temperature Range: -25°C ~ +85°C
 Contact Resistance: 20mΩ Max
 Insulation Resistance: 100MΩ Min
 Withstanding Voltage: 1000V AC/minute
 Pin Material: Brass/Tin-plated
 Material: Nylon 66,UL94V-0
 Pantone Color: 153C~154C

Ordering Information & Dimensions

PART NO.	Dimensions	
	A	B
A2100WV-02P	2.00	6.00
A2100WV-03P	4.00	8.00
A2100WV-04P	6.00	10.00
A2100WV-05P	8.00	12.00
A2100WV-06P	10.00	14.00
A2100WV-07P	12.00	16.00
A2100WV-08P	14.00	18.00
A2100WV-09P	16.00	20.00
A2100WV-10P	18.00	22.00
A2100WV-11P	20.00	24.00
A2100WV-12P	22.00	26.00
A2100WV-13P	24.00	28.00
A2100WV-14P	26.00	30.00
A2100WV-15P	28.00	32.00

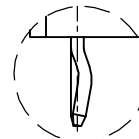
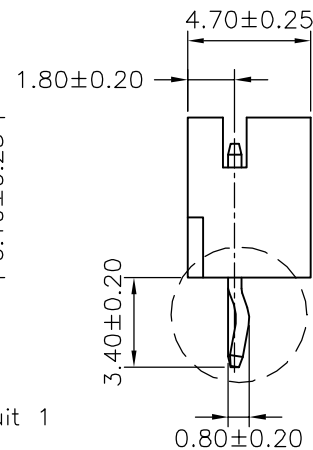
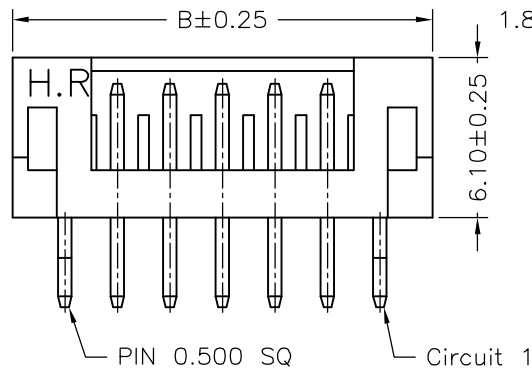
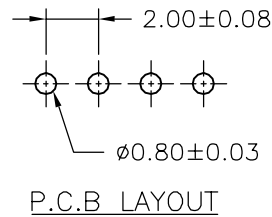
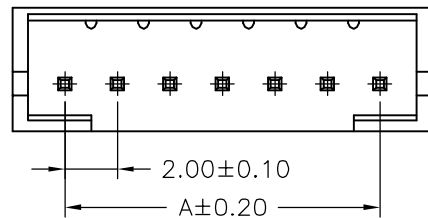

TYPE 1

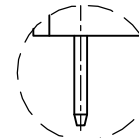

TYPE 3

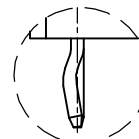

TYPE 2

UNIT	SCALE	SHEET	TITLE:
mm		1 of 1	2.00mm PITCH 180° WAFER
DRAWN BY		APPROVED BY	
董正一		董正一	
2001.02.01		2001.02.01	
GENERAL TOLERANCE			
B1	REVISE	2009.04.23	X. X±0.25
B0	NEW RELEASE	2006.01.07	X. XX±0.15
REV.	DESCRIPTION	DATE	X. XXX±0.05
DRAW NO.:			REV.
A2100WV-XPX			B1

X-ON Electronics

Largest Supplier of Electrical and Electronic Components

Click to view similar products for [Headers & Wire Housings](#) category:

Click to view products by [Joint Tech](#) manufacturer:

Other Similar products are found below :

[95000-104TRLF](#) [10135584-644402LF](#) [DF62W-EP2022PCA](#) [95000-106TRLF](#) [DF62W-2022SCA](#) [DF62W-EP2022PC](#) [2203348](#) [DF62W-2022SC](#) [1084018](#) [1029039](#) [1084017](#) [802-10-012-10-002000](#) [1112640](#) [1112639](#) [891-007-9SS-BST1T](#) [000-34000](#) [0008550134](#) [0009482033](#) [0009507031](#) [57102-F02-18ULF](#) [57102-S06-03LF](#) [57202-S52-04LF](#) [PCN6-15S-2.5E](#) [0039019024](#) [58102-G61-06LF](#) [582553-1](#) [0009485154](#) [0009508121](#) [0022285053](#) [0050291907](#) [018731A](#) [LY20-4P-DT1-P1E-BR](#) [02.125.8002.8](#) [60101931](#) [60598-1 \(Cut Strip\)](#) [M1625-3R/100](#) [61062-3](#) [61082-181009](#) [CSU011177004](#) [636-1427](#) [638009-1](#) [641938-9](#) [641991-4](#) [644168-1](#) [644827-2](#) [647662-1](#) [65039-019ELF](#) [65692-001LF](#) [65781-018](#) [65781-047](#)