

P/N LEGEND

A7925	WV	-F	-XP	R	N	N	XX	N	00	G
①	②	③	④	⑤	⑥	⑦	⑧	⑨	⑩	⑪

① Series No.
 ② Connector type: WV=Vertical
 ③ Mounting type: F=With boss
 ④ No. of circuits
 ⑤ R=RoHs
 ⑥ Material: N=Nylon66-V0, NO FLAME
 ⑦ Color: N=Natural
 ⑧ Plating code for contacts:
 T1=Tin-plated 80u" MIN over Nickel-plated 30u" MIN
 HC=Gold-plated 8u" MIN on contact area,
 Matte Tin-plated 80u" MIN on solder area
 over Nickel-plated 30u"
 ⑨ Plating code: N=Non-plating
 ⑩ Option code: 00=Standard
 ⑪ Packing code: G=Bag

SPECIFICATIONS
 Current Rating: 13A~30A AC,DC
 Voltage Rating: 600V AC,DC
 Temperature Range: -55°C ~ +85°C
 Contact Resistance: 5mΩ Max.
 Insulation Resistance: 1000MΩ Min.
 Withstanding Voltage: 2500V AC/minute
 Pin Material: High conductivity copper alloy

Circuit No.	Dimensions	
	A	B
02P	7.92	17.22
03P	15.84	25.14
04P	23.76	33.06
05P	31.68	40.98

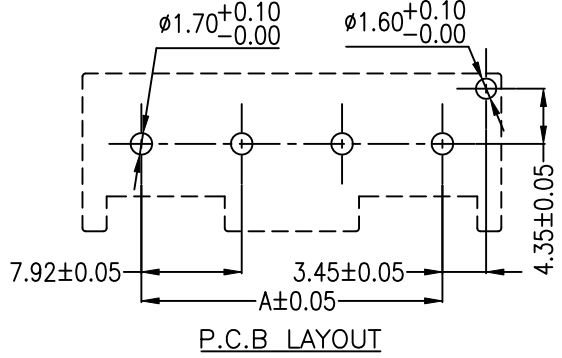
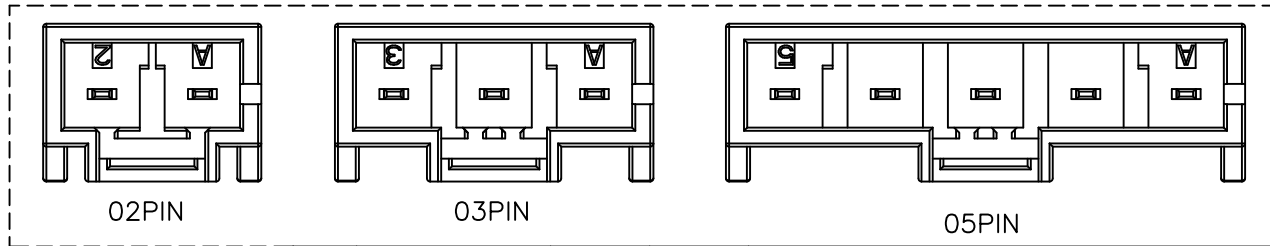
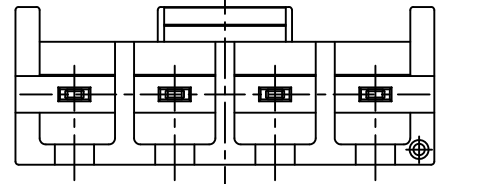
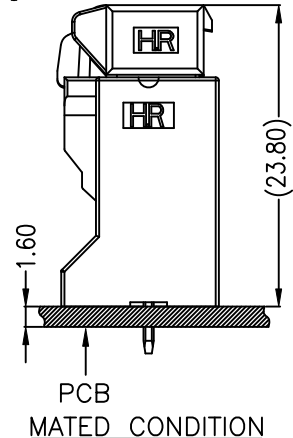
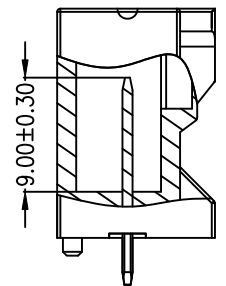
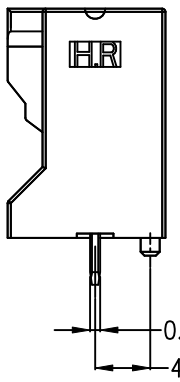
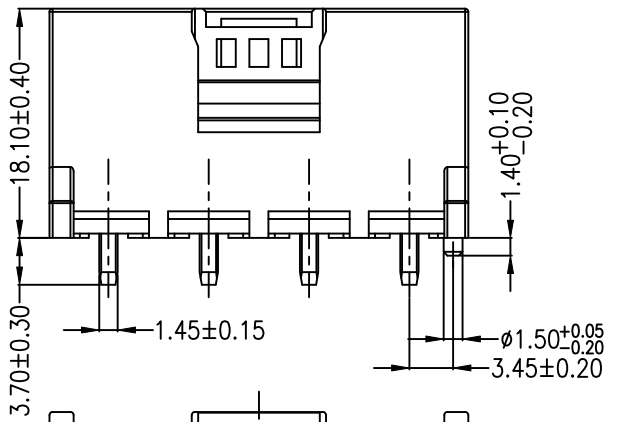

				UNIT	SCALE	SHEET	TITLE:
				mm	1 : 1	1 of 1	
DRAWN BY		APPROVED BY		7.92mm PITCH 180° WAFER STANDARD TYPE			
鄭小嬌		徐富永					
2022.06.20		2022.06.20					
GENERAL TOLERANCE				DRAW NO. :			
X. X±0.25		ANGLE±		A7925WV-F-XPRXXXXX00G			
X. XX±0.15		▽					
X. XXX±0.05		⊕		REV. A0			
A0	NEW RELEASE	2022.06.20	鄭小嬌				
REV.	DESCRIPTION	DATE	NAME				

X-ON Electronics

Largest Supplier of Electrical and Electronic Components

Click to view similar products for [Headers & Wire Housings](#) category:

Click to view products by [Joint Tech](#) manufacturer:

Other Similar products are found below :

[0015917161](#) [0022155065](#) [57102-F02-18ULF](#) [58102-G61-06LF](#) [582553-1](#) [01.001.5753.1](#) [0050291907](#) [02.125.8002.8](#) [609-3404](#) [61062-3](#)
[CSU011177004](#) [622-0430](#) [622-3653LF](#) [63453-116](#) [636-1030](#) [636-1427](#) [636-3427](#) [636-4007](#) [641938-9](#) [65495-038](#) [65692-001LF](#) [65781-018](#)
[65781-047](#) [65817-010LF](#) [65817-015LF](#) [67095-007LF](#) [67601157](#) [68631-112](#) [68645-018](#) [699319-000](#) [70.362.1628.0](#) [70-4210](#) [70-4226B](#) [70-](#)
[4853B](#) [71.350.2428.0](#) [733-134](#) [733-162](#) [760-3052](#) [MHR-64-VUAL](#) [80.063.4001.1](#) [800-90-001-10-001000](#) [801-43-002-10-013000](#)
[801-43-006-10-002000](#) [803-43-024-10-001000](#) [803-93-012-10-001000](#) [8-1437020-4](#) [819-22-004-30-001101](#) [820-22-006-30-001101](#)
[820-22-008-30-001101](#) [821-22-002-10-001101](#)