



a module solution provider

# MM5D91-00

60GHz mmWave Radar

Presence Detection Sensor Module

Datasheet

Revision 1.0

Prepared By	Reviewed By	Approved By

## Index

<b>1. INTRODUCTION .....</b>	<b>2</b>
1.1. GENERAL FEATURES .....	2
1.2. PRESENCE DETECTION FEATURES .....	2
<b>2. HARDWARE INFORMATION .....</b>	<b>3</b>
2.1. BLOCK DIAGRAM .....	3
2.2. MODULE PIN DEFINE .....	4
2.3. RECOMMENDED OPERATING.....	6
2.4. BUILT-IN ANTENNA SPECIFICATIONS.....	6
<b>3. RADAR RADIATION PATTERN .....</b>	<b>7</b>
3.1. TEST SETUP .....	7
3.2. RADIO PATTERN .....	8
<b>4. EVALUATION KIT .....</b>	<b>9</b>
4.1. EVALUATION HARDWARE DESCRIPTION .....	10
<b>5. CONFIGURABILITY .....</b>	<b>11</b>
<b>6. REFERENCE OF DESIGN.....</b>	<b>12</b>
6.1. REFERENCE SCHEMATIC .....	12
6.2. DESIGN RECOMMENDATION .....	13
<b>7. PACKAGE INFORMATION.....</b>	<b>14</b>
7.1. MODULE DIMENSION.....	14
7.2. RECOMMENDED LAND PATTERN .....	15
7.3. DEVICE LABEL .....	16
7.4. TAPE REEL INFORMATION .....	17
<b>8. SMT / BAKING INFORMATION .....</b>	<b>18</b>
8.1. BAKING RECOMMENDATION .....	18
8.2. SMT RECOMMENDATION .....	18
<b>9. ORDERING INFORMATION .....</b>	<b>19</b>
<b>10. HISTORY CHANGE .....</b>	<b>19</b>

## 1. INTRODUCTION

The MM5D91-00 is the presence detection sensor module which integrates 60GHz mmWave technology. The module simplifies the implementation of mmWave sensors in the band of 61.0 to 61.5GHz, and it includes the ARM Cortex-M4F based processor system, 1Tx 3Rx antenna and onboard regulator. This presence detection sensor module targets low power and high resolution presence detection in smart home, office, security and diverse applications.

### 1.1. General Features

- ARM Cortex-M4F 150MHz, 1024KB Flash, 288KB RAM
- Built-in Antenna (1Tx, 3Rx)
- Built-in Regulator
- UART interface and GPIOs
- 3.6~5.5V Power input
- 26pin pitch 1.27mm Castellated Holes
- Dimensions: 20 x 15 x 2.3 mm

### 1.2. Presence Detection Features

- Presence sensing for home, office and commercial buildings
- Adjustable detection range
- Field of View of Radar : Azimuth:  $\pm 45^\circ$  / Elevation:  $\pm 40^\circ$
- Supported moving object speed (m/sec): up to 2.0 m/sec
- Static objects (non-living) are not detected
- Able to detect presence ( $\leq 1$ sec) when at least one moving object is present
- Absence is declared in around 3sec (both macro and micro modes enabled).  
Configurable up to 30sec
- Detection Range :

※ Detection up to 10m for macro motion <sup>(1)</sup>

※ Detection up to 5m for micro motion <sup>(2)</sup>

(1) Macro motion: human movements

(2) Micro motion:

Stationary human (normally breathing and blinking eyes) in sitting or standing positions with no active movements for at least 30 sec.

## 2. HARDWARE INFORMATION

### 2.1. Block Diagram

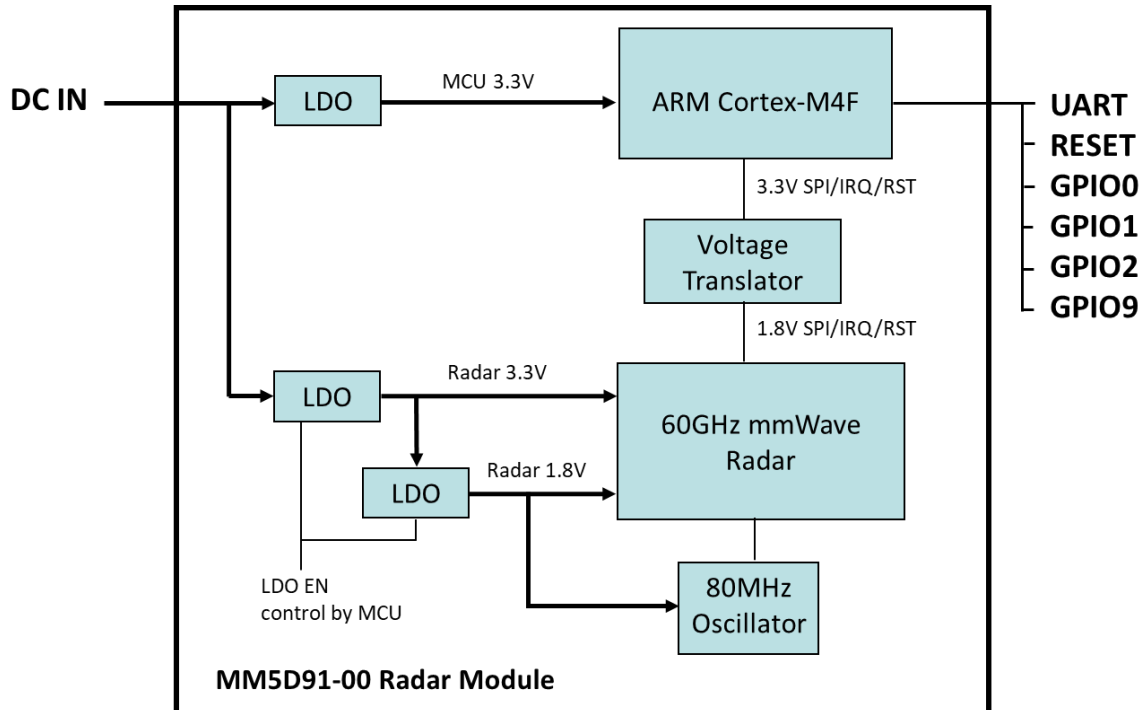

Figure 2-1. MM5D91-00 Block Diagram

## 2.2. Module Pin Define

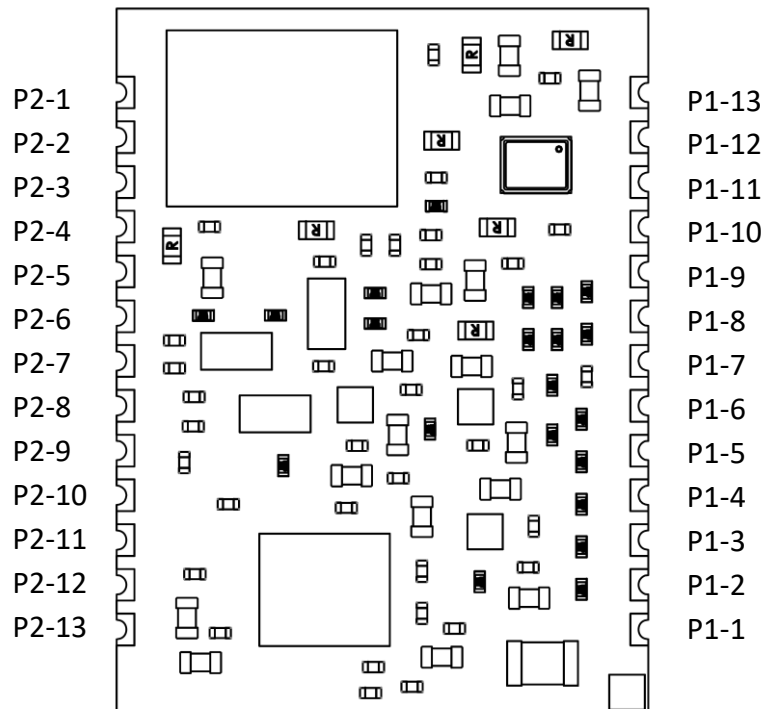

Figure 2-2. MM5D91-00 Module View

### P1 Pin define:

Pin No.	Signal Name	Description
P1-1	NC	No Used.
P1-2	NC	No Used.
P1-3	NC	No Used.
P1-4	NC	No Used.
P1-5	NC	No Used.
P1-6	NC	No Used.
P1-7	NC	No Used.
P1-8	nRESET	Reset for radar module. Internal pull high default.
P1-9	UART_TX	UART Transmit. Reserve test point for firmware upgrade.
P1-10	UART_RX	UART Receive. Reserve test point for firmware upgrade.
P1-11	NC	No Used.
P1-12	NC	No Used.
P1-13	GND	Ground.

**P2 Pin define:**

Pin No.	Signal Name	Description
P2-1	NC	No Used.
P2-2	NC	No Used.
P2-3	GPIO0	GPIO0. Default low, green color for presence indication.
P2-4	GPIO1	GPIO1. Default low, red color for not presence indication.
P2-5	GPIO2	GPIO2. Default low, blue color for bootloader mode indication.
P2-6	NC	No Used.
P2-7	NC	No Used.
P2-8	NC	No Used.
P2-9	NC	No Used.
P2-10	NC	No Used.
P2-11	NC	No Used.
P2-12	GPIO9	GPIO9. Please Pull high 1K ohm to VIO.
P2-13	DC_IN	Power supply input. Range from 3.6V to 5.5V.

### 2.3. Recommended Operating

Parameter		Min	Typ	Max	Units
DC_IN	DC supply input	3.6		5.5	V
VIH	IO high-level input voltage	2.3	-	-	
VIL	IO low-level input voltage	-	-	1	
Current Consumption @ DC_IN=5V <sup>(1)</sup>	Presence detect mode on		12.0		mA
	Presence detect mode off		3.7		
	Deep sleep mode		0.04		
Phase noise	At 100KHz offset		-80		dBc/Hz
Operating Temperature <sup>(2)</sup>		-20		70	°C
Storage Temperature		-40		85	°C

(1) Based on firmware 237a4fe version.

(2) Means ambient temperature when working.

### 2.4. Built-in Antenna Specifications

Parameter		Min	Typ	Max	Units
RX_BW, TX_BW	Antenna bandwidth	61.0		61.5	GHz
Output Power	EIRP		+7.5		dBm
Antenna gain of single TX		2.0	3.5	5.0	dBi
Antenna gain of single RX		2.0	3.5	5.0	dBi
Field of View of Azimuth		70	90	110	Deg
Field of View of Elevation		60	80	100	Deg

### 3. RADAR RADIATION PATTERN

#### 3.1. Test Setup

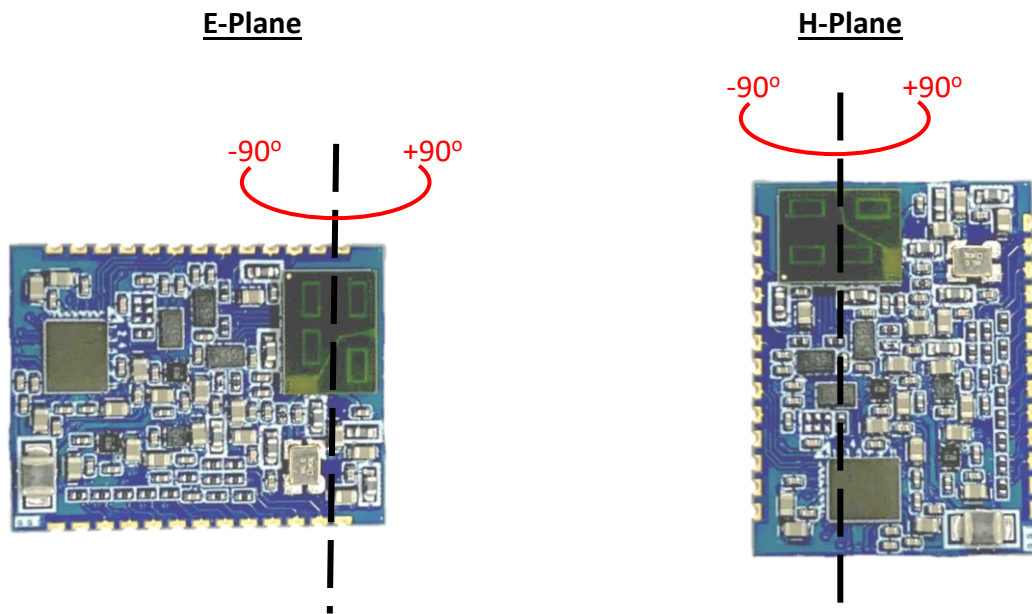

Figure 3-1. Antenna Setup



### 3.2. Radio Pattern

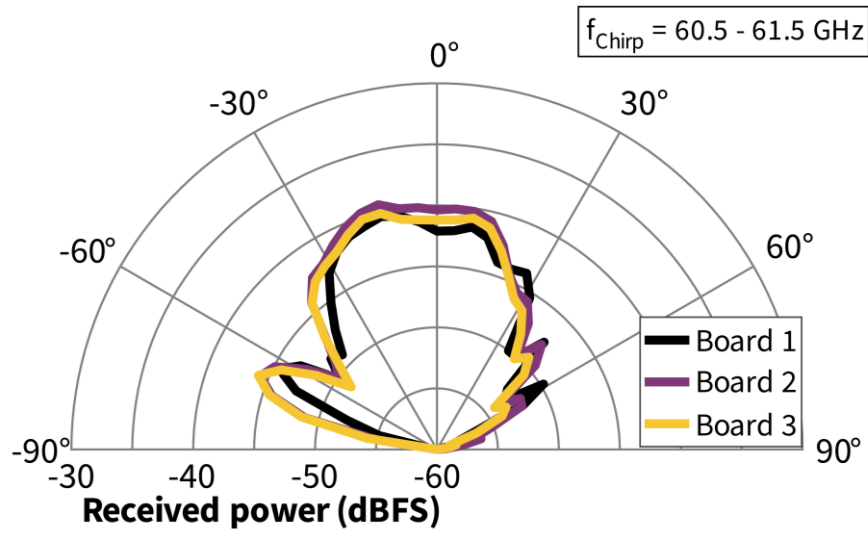

Figure 3-2. Radiation Pattern of the E-Plane

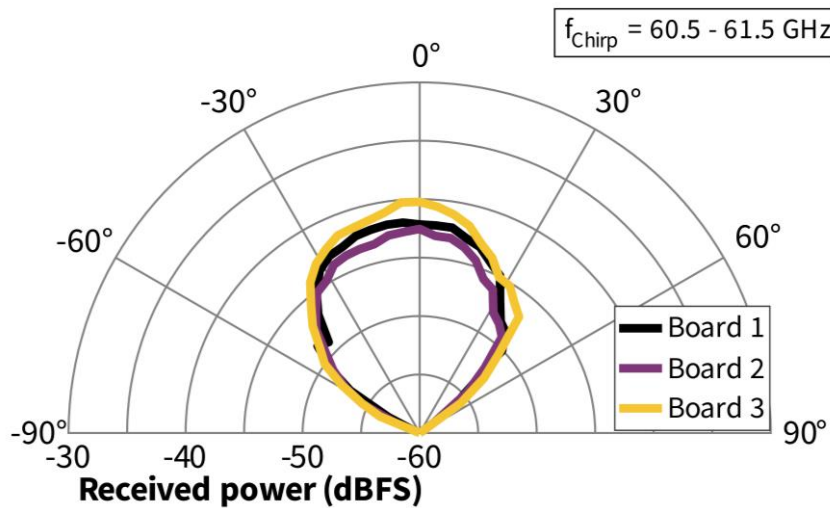

Figure 3-3. Radiation Pattern of the H-Plane

#### 4. EVALUATION KIT

The Jorjin mmWave Radar sensor evaluation kit MM5D91E00 show as below. Based on the MM5D91-00 Radar sensor module, evaluation board is built to demonstrate the function of presence detection of the 60 GHz radar sensor with its sophisticated radar presence detection algorithms. This evaluation kit easy to demo and development for customer.

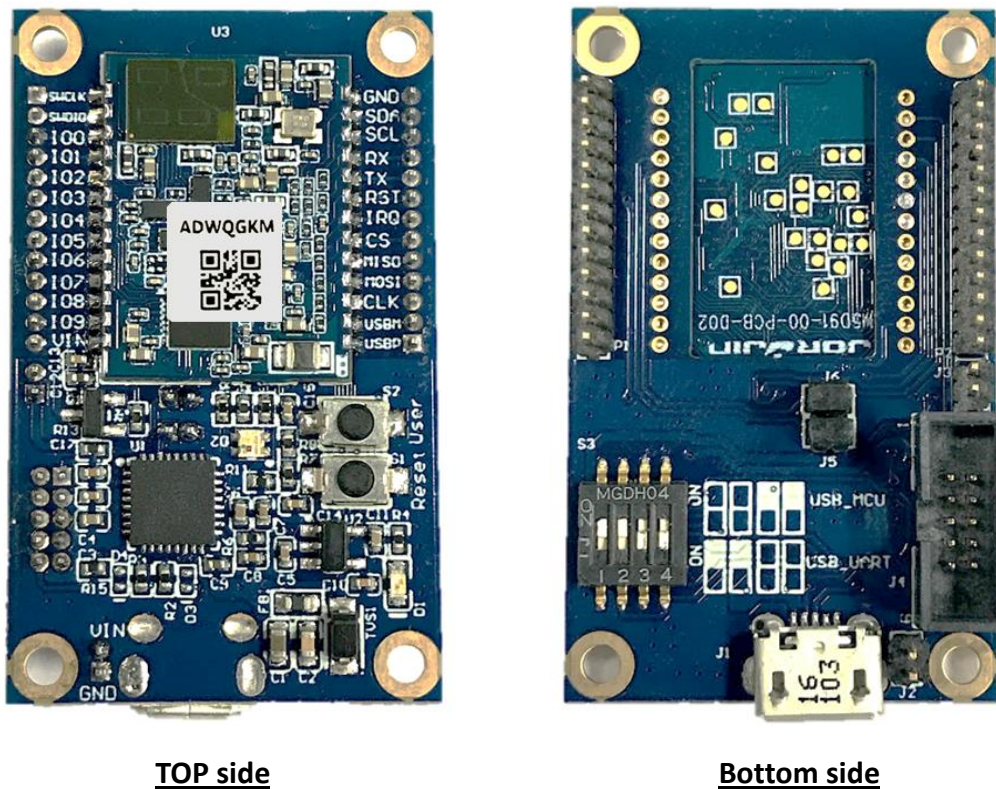

Figure 4-1. MM5D91E00 mmWave Radar Evaluation Kit

### 4.1. Evaluation Hardware Description

The following figure and table describe physical sections of the board.

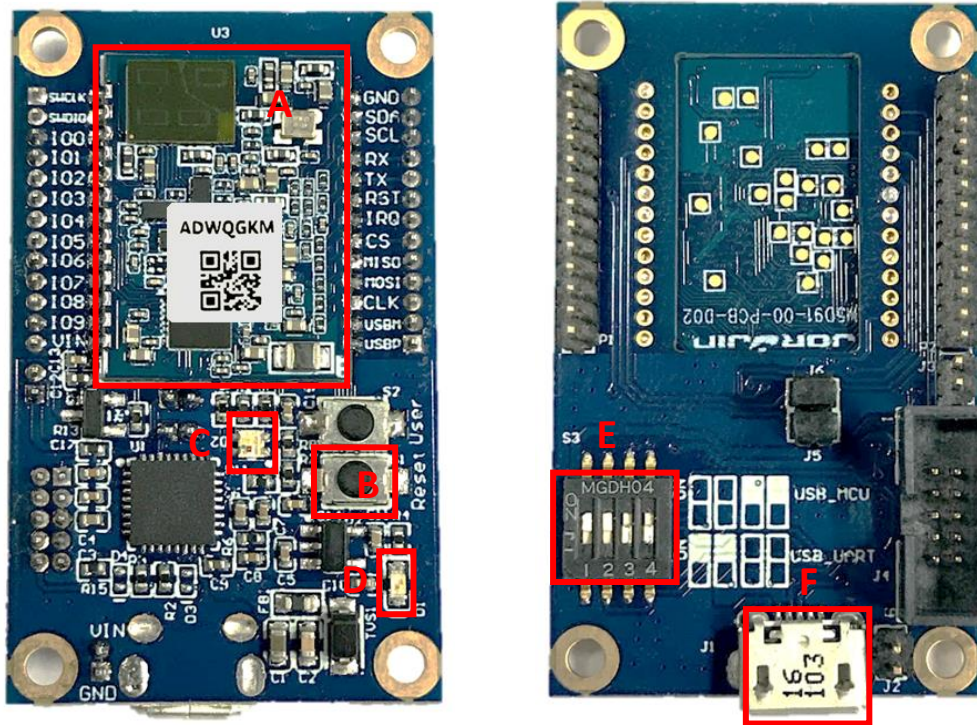

Figure 4-1. Hardware description of Evaluation Kit

Table 4-1. Evaluation Kit component descriptions list

Region	Description
A	Jorjin mmWave Radar sensor module.
B	Radar sensor module reset switch.
C	Red LED light when the evaluation kit is power on.
D	LED of radar detect status: - Green color : No presence. - Red color : Presence detected.
E	Interface setting: Turn up of left two / Turn down of right two. Please keep the setting always.
F	Micro USB connector. Connected to PC (config tool) or power bank to demo.

## 5. CONFIGURABILITY

- Easy Configuration UART port for the end user to change parameters
- Standard mode: Detection range, sensitivity, reset etc.
- Expert mode: macro/micro modes, thresholds etc.
- The detection range, sensitivity and status settings are stored in the flash and remain set after power reboot.

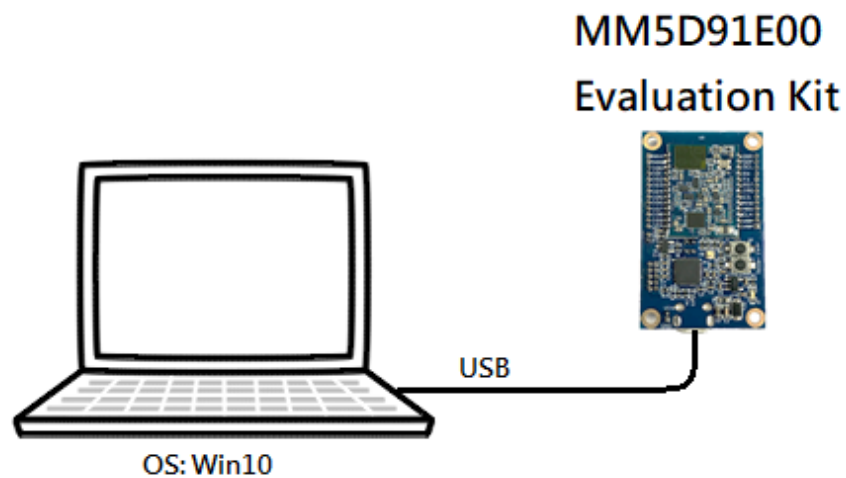

If the OS is win7 or lower , please find the USB driver as [the link](#).

**Figure 5-1. Radar module connect to PC**

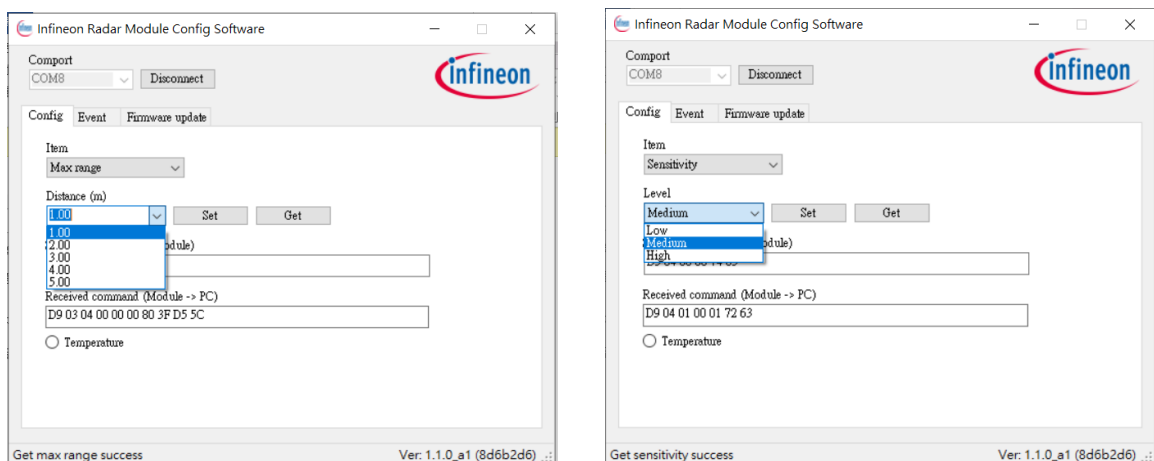

**Figure 5-2. Radar Module Configuration software**

## 6. REFERENCE OF DESIGN

### 6.1. Reference Schematic

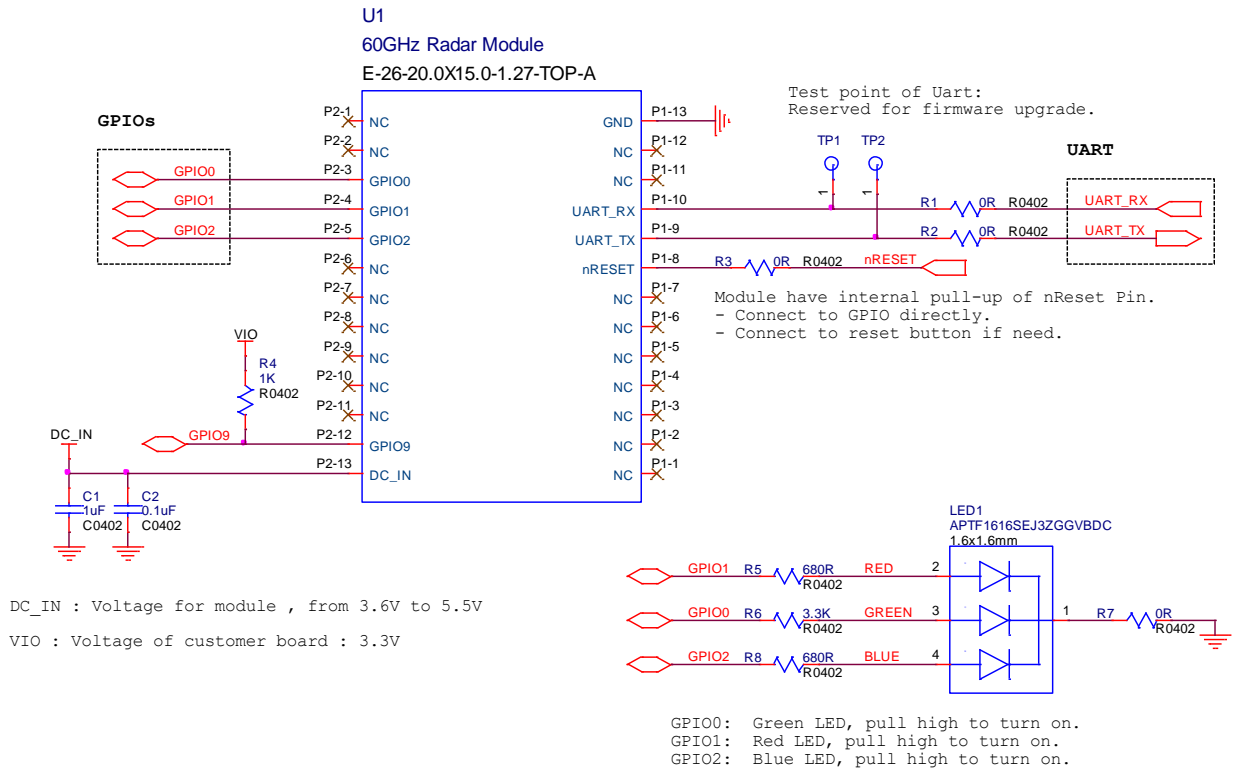
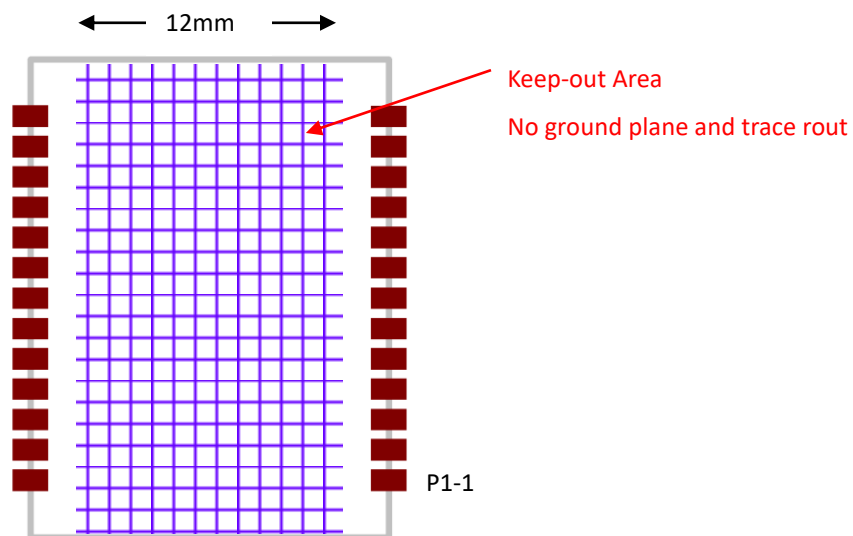

Figure 6-1. MM5D91-00 Radar Module Reference Circuit

## 6.2. Design Recommendation

1. Please reserve the test points of UART for firmware upgrade in the future.
2. Please keep the module solder layer that no ground plane and trace rout in the keep-out area. Show in Figure 6-2.
3. The power trace for DC\_IN must be at least 20-mil wide.



**Figure 6-2. Recommend Layout of Radar module**

**7. PACKAGE INFORMATION**

**7.1. Module Dimension**

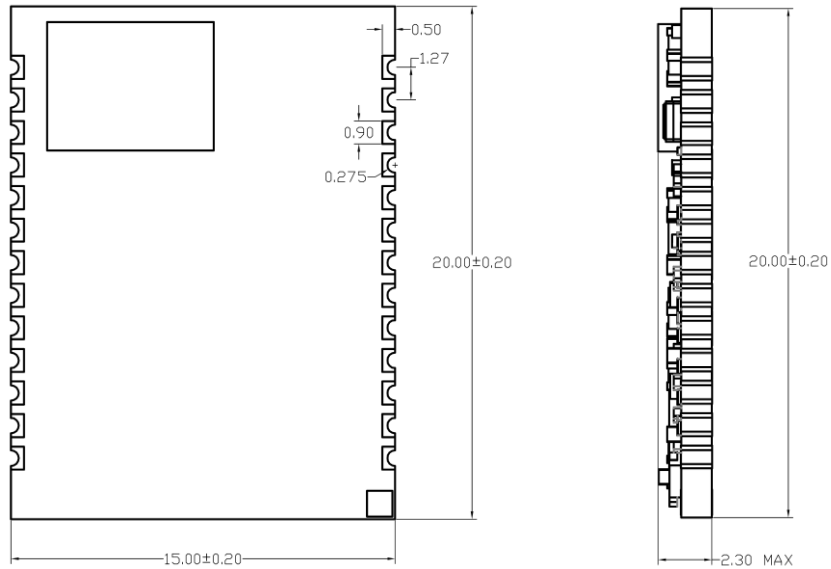

Top View

Side View

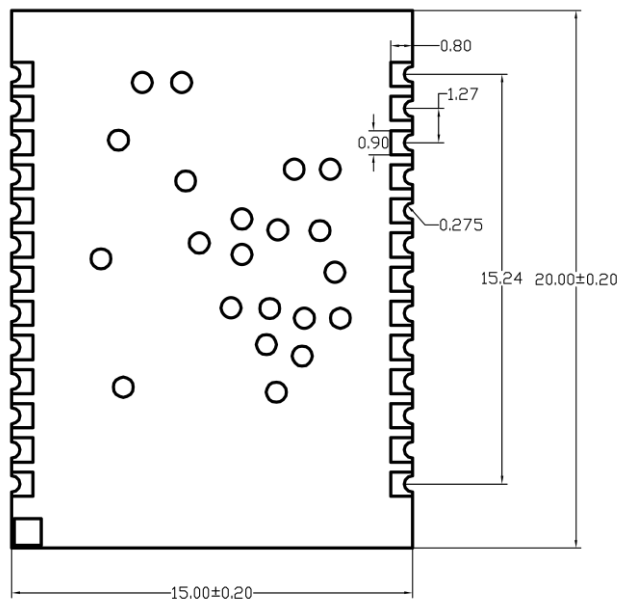

Unit: mm

Bottom View

**Figure 7-1. MM5D91-00 Module Dimension**

## 7.2. Recommended Land Pattern

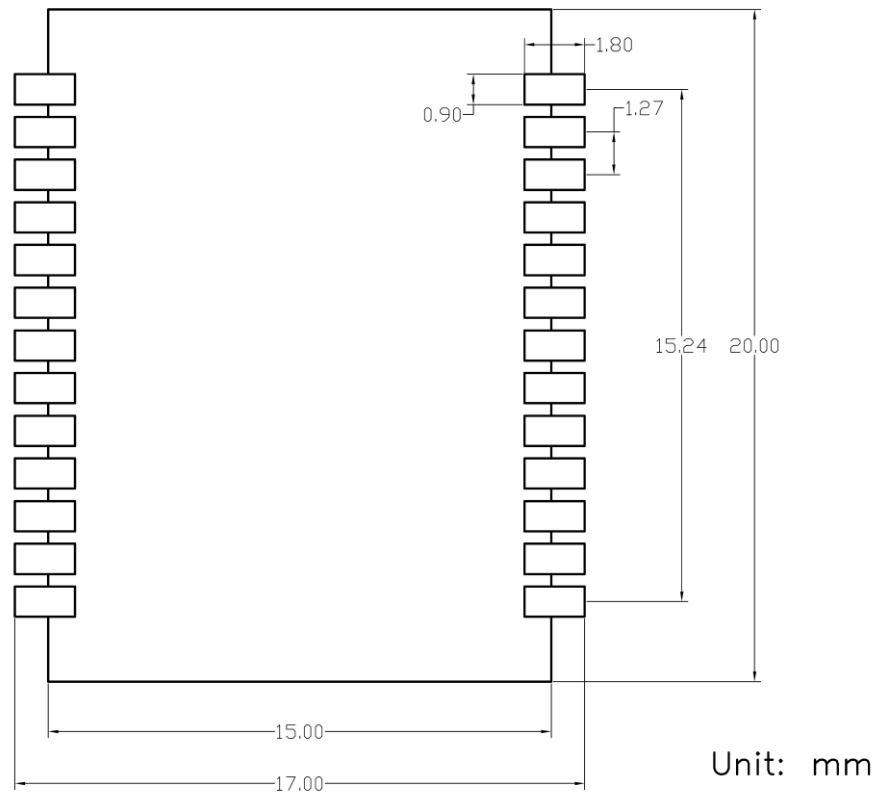
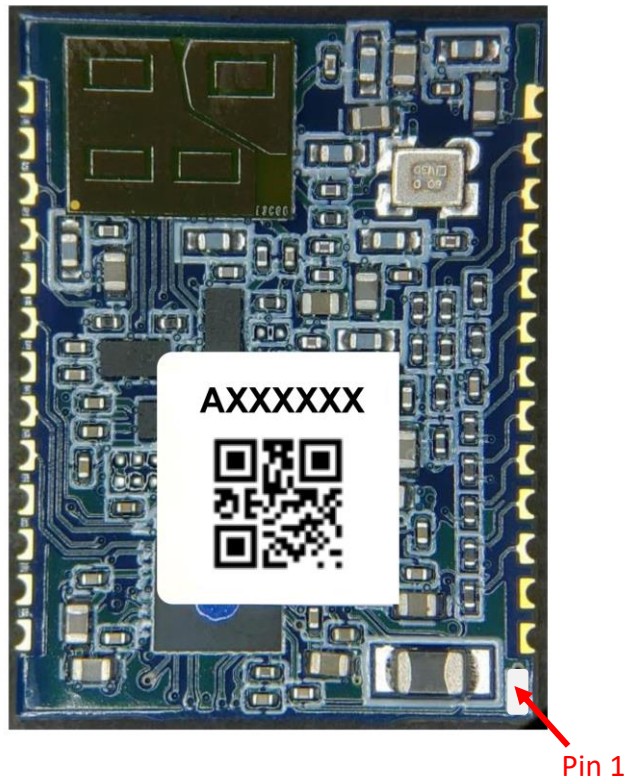

Figure 7-2. Recommended Land Pattern Dimension



### 7.3. Device Label



Marking	Description
<p>QR Code :</p> <p>YYWW,AXXXXXX</p>	<p>YY : Digit of the year, ex: 2019=19</p> <p>WW : Week (01~52)</p> <p>A : Product Number, ex: A=MM5D91-00</p> <p>XXXXXX : Series number.</p>

### 7.4. Tape Reel information

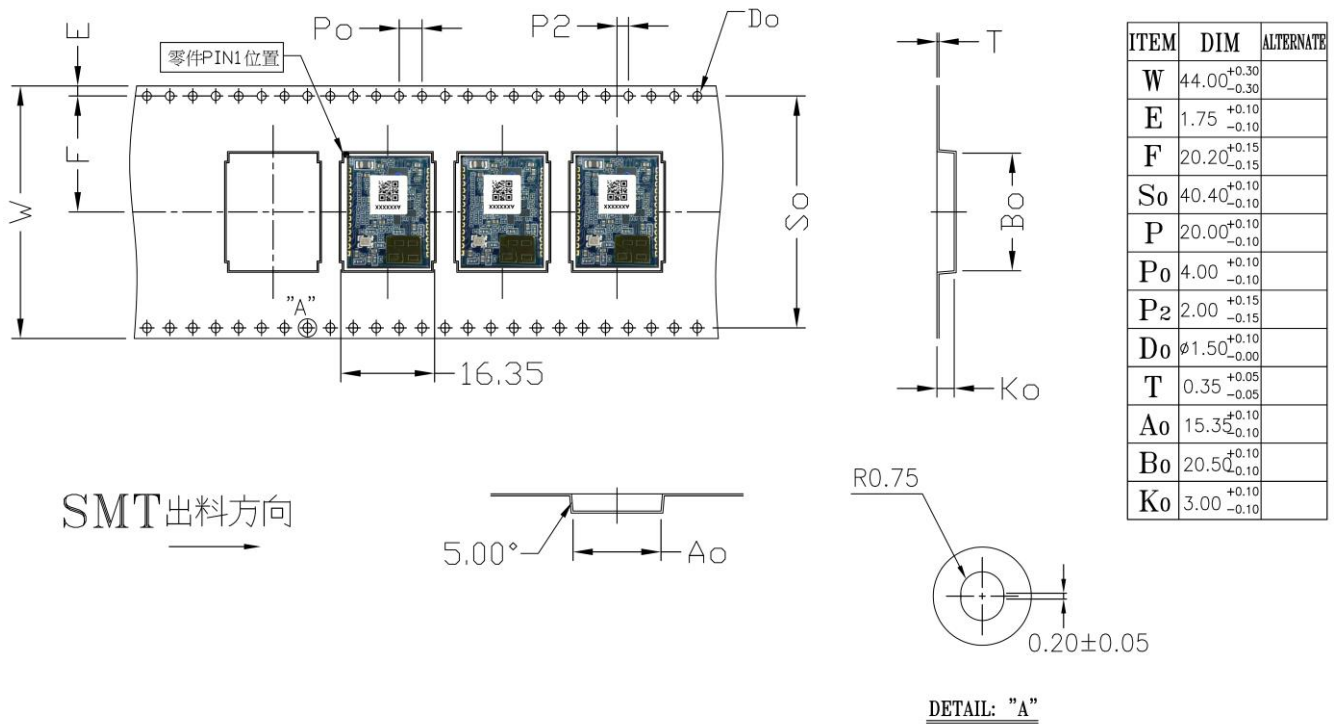

Reel : 1000 pcs per reel



Pizza Box : 1 reel per pizza box

## 8. SMT / BAKING INFORMATION

### 8.1. Baking Recommendation

Baking condition:

- Follow MSL Level 4 to do baking process.
- After bag is opened, devices that will be subjected to reflow solder or other high temperature process must be
  - a. Mounted within 72 hours of factory conditions <30°C / 60% RH
  - b. Stored at <10% RH.
- Devices require bake, before mounting, if Humidity Indicator Card reads >10%
- If baking is required, Devices may be baked for 8 hrs at 125 °C.

### 8.2. SMT Recommendation

Recommended Reflow profile:

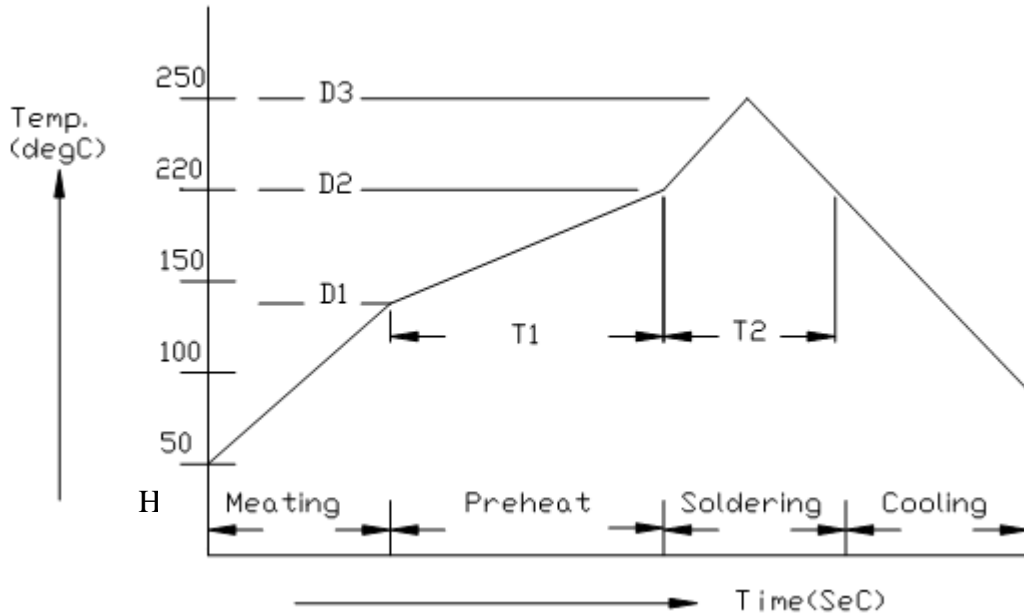

No.	Item	Temperature (°C)	Time (sec)
1	Pre-heat	D1: 140 ~ D2: 200	T1: 80 ~ 120
2	Soldering	D2: = 220	T2: 60 +/- 10
3	Peak-Temp.	D3: 250 °C max	

Note-1: Reflow soldering is recommended two times maximum.

Note-2: Add Nitrogen while Reflow process: SMT solder ability will be better.

- **Stencil thickness:** 0.1~ 0.13 mm (Recommended)
- **Soldering paste (without Pb):**  
Recommended SENJU N705-GRN3360-K2-V can get better soldering effects.

## 9. ORDERING INFORMATION

Order number	Description
MM5D91-00A	Presence Detection Sensor module
MM5D91E00	Evaluation kit of MM5D91-00

## 10. HISTORY CHANGE

Revision	Date	Description
Revision 1.0	2020-12-03	Official version release.

## **X-ON Electronics**

Largest Supplier of Electrical and Electronic Components

*Click to view similar products for [Position Sensor Modules](#) category:*

*Click to view products by [Jorjin](#) manufacturer:*

Other Similar products are found below :

[1604](#) [MM5D91-00](#) [OPB9001A](#) [OPB9001AC](#) [OPB9001B](#) [OPB9001C](#) [SEN0017](#) [SEN0395](#)