

Preliminary Specifications Subject to Change without Notice

DESCRIPTION

The JW[®]7115Sx/JW7111Sx is a single channel current-limited power switch optimized for Universal Serial Bus (USB) and other hot-swap applications. The rising and falling times are controlled to minimize current overshoot or undershoot during switches on/off.

The device has fast short-circuited response time for improved overall system robustness. It provides a complete protection solution, such as reverse current blocking and limit, over-current protection, over-temperature protection and short-circuit protection, as well as controlled rising time and under-voltage lockout function. A 7.5ms de-glitch time on the open-drain flag output prevents false over-current reporting.

JW7115Sx offers both SOT23-5 and TSOT23-5 packages. JW7111Sx offers both DFN2X2-6 and SOT23-6 packages.

Company's Logo is Protected, "JW" and "JOULWATT" are Registered Trademarks of JoulWatt technology Inc.

FEATURES

- Accurate current limit
- FLG: active low
- Reverse current blocking during shutdown and reverse current limit during enable
- Constant-current during over-current
- Fast short-circuit response time: 2μs (typ.)
- Operating range: 2.7V - 5.5V
- Over-current protection, short-circuit Protection and thermal protection
- Fault report (FAULT) with de-glitch time
- UL recognized, file number E497605
- IEC recognized, file number DK-83242-UL and DK-90295-UL
- ESD protection: 2kV HBM, 500V CDM
- Available in SOT23-5, TSOT23-5, SOT23-6 and DFN2X2-6 Packages

APPLICATIONS

- Set-Top Boxes
- LCD TVs & Monitors
- Residential Gateways
- Laptops, Desktops, Servers, e-books, Printers, Docking
- Stations, HUBs

TYPICAL APPLICATION

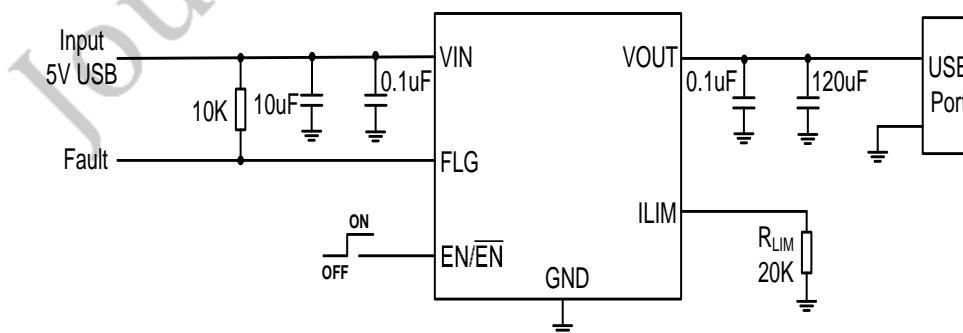

ORDER INFORMATION

| DEVICE ¹⁾ | PACKAGE | TOP MARKING ²⁾ | ENABLE | CURRENT LIMIT |
|-------------------------|----------|---------------------------|-------------|---------------|
| JW7115SSOTA#TRPBF | SOT23-5 | JWLX□ YW□□□ | Active High | 3.2A |
| JW7115S-1SOTA#TRPBF | SOT23-5 | JWLY□ YW□□□ | Active High | 1.3A |
| JW7115S-2SOTA#TRPBF | SOT23-5 | JWLZ□ YW□□□ | Active High | 2.2A |
| JW7115S-2.5SOTA#TRPBF | SOT23-5 | JWCX□ YW□□□ | Active High | 2.85A |
| JW7115S-2.5TSOTA#TRPBF | TSOT23-5 | JWDL□ YW□□□ | Active High | 2.85A |
| JW7115SASOTA#TRPBF | SOT23-5 | JWMA□ YW□□□ | Active Low | 3.2A |
| JW7115SA-1SOTA#TRPBF | SOT23-5 | JWMB□ YW□□□ | Active Low | 1.3A |
| JW7115SA-2SOTA#TRPBF | SOT23-5 | JWMC□ YW□□□ | Active Low | 2.2A |
| JW7115SA-2.5SOTA#TRPBF | SOT23-5 | JWCY□ YW□□□ | Active Low | 2.85A |
| JW7115SA-2.5TSOTA#TRPBF | TSOT23-5 | JWDK□ YW□□□ | Active Low | 2.85A |
| JW7111SSOTB#TRPBF | SOT23-6 | JWCR□ YW□□□ | Active High | RSET |
| JW7111SDFNB#TRPBF | DFN2x2-6 | JWCS□ YW□□□ | Active High | RSET |
| JW7111SASOTB#TRPBF | SOT23-6 | JWCT□ YW□□□ | Active Low | RSET |
| JW7111SADFNB#TRPBF | DFN2x2-6 | JWCU□ YW□□□ | Active Low | RSET |

Notes:

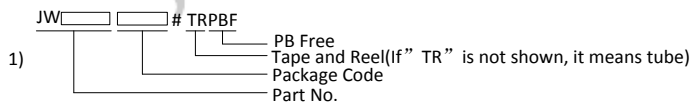

PIN CONFIGURATION

TOP VIEW

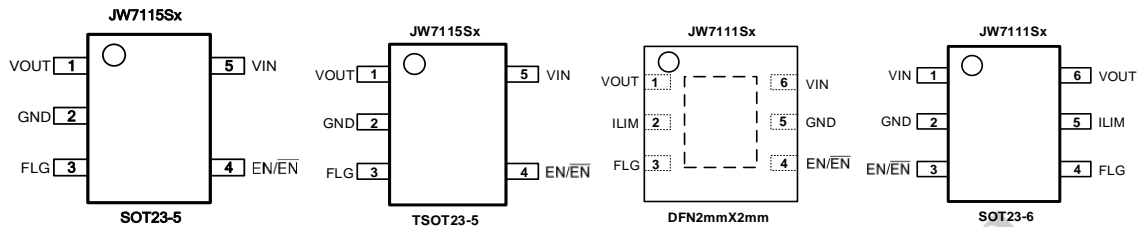

ABSOLUTE MAXIMUM RATING¹⁾

| | |
|--|-----------------|
| VIN PIN Voltage | -0.3V to 6.5V |
| VOUT PIN Voltage..... | -0.3V to 6.5V |
| Other Pins Voltage..... | -0.3V to 6.5V |
| Continuous Switch Current Of JW7115S-1/JW7115SA-1..... | 1A |
| Continuous Switch Current Of JW7115S-2/JW7115SA-2..... | 2A |
| Continuous Switch Current Of JW7115S-2.5/JW7115SA-2.5..... | 2.5A |
| Continuous Switch Current Of JW7115S/JW7115SA..... | 3A |
| ILIM Source Current..... | 1mA |
| Junction Temperature ^{2) 3)} | 150°C |
| Lead Temperature | 260°C |
| Storage Temperature | -65°C to +150°C |

RECOMMENDED OPERATING CONDITIONS

| | |
|--|-----------------|
| VIN PIN Voltage | 2.7V to 5.5V |
| VOUT PIN Voltage..... | 0V to(VIN+0.2V) |
| EN/EN PIN Voltage..... | 0V to 5.5V |
| High-Level Input Voltage on EN/EN..... | 1.4V to VIN |
| Low-Level Input Voltage on EN/EN..... | 0V to 0.5V |
| Operating Junction Temperature..... | -40°C to 125°C |

THERMAL PERFORMANCE⁴⁾

| | θ_{JA} | θ_{JC} |
|---------------|---------------|---------------|
| SOT23-5..... | 180 | 130°C/W |
| TSOT23-5..... | 120 | 60°C/W |
| DFN2X2-6..... | 120 | 34°C/W |
| SOT23-6..... | 180 | 130°C/W |

Note:

- 1) Exceeding these ratings may damage the device. These stress ratings do not imply function operation of the device at other conditions beyond those indicated under RECOMMENDED OPERATING CONDITIONS.
- 2) The JW7115Sx/JW7111Sx includes thermal protection that is intended to protect the device in overload conditions.
- 3) Measured on JESD51-7, 4-layer PCB.

ELECTRICAL CHARACTERISTICS

| <i>TA = +25°C, VIN = 2.7V to 5.5V, VEN = 0V or VEN = VIN, unless otherwise stated.</i> | | | | | | | |
|--|---------------------|--|---|------|------|------|-------|
| Item | Symbol | Condition ⁵⁾ | | Min. | Typ. | Max. | Units |
| <i>Supply</i> | | | | | | | |
| Input UVLO | V _{UVLO} | VIN Rising | | | 2.4 | 2.65 | V |
| Input UVLO Hysteresis | ΔV _{UVLO} | VIN Decreasing | | | 50 | | mV |
| Input Shutdown Current | I _{SHDN} | VIN= 5.5V, Disabled, V _{OUT} = Open | | | 0.1 | 1 | uA |
| Input Quiescent Current | I _q | JW7115Sx | VIN= 5.5V, Enabled, V _{OUT} = Open | | 80 | 130 | uA |
| | | JW7111Sx | VIN= 5.5V, Enabled, V _{OUT} = Open, RLIM=20kΩ | | 100 | 150 | uA |
| | | JW7111Sx | VIN= 5.5V, Enabled, V _{OUT} = Open, RLIM=210kΩ | | 80 | 130 | uA |
| <i>Power Switch</i> | | | | | | | |
| Switch On-Resistance | R _{DS(ON)} | JW7115S-1/ JW7115SA-1 | T _J = +25°C, VIN= 5.0V , Load=1A | | 50 | 60 | mΩ |
| | | JW7115S-2/ JW7115SA-2 | T _J = +25°C, VIN= 5.0V , Load=1A | | 45 | 55 | |
| | | JW7115S-2.5/ JW7115SA-2.5 SOT23-5 | T _J = +25°C, VIN= 5.0V , Load=1A | | 33 | 40 | |
| | | JW7115S-2.5/ JW7115SA-2.5 TSOT23-5 | T _J = +25°C, VIN= 5.0V , Load=1A | | 33 | 40 | |
| | | JW7115S/ JW7115SA | T _J = +25°C, VIN= 5.0V , Load=1A | | 33 | 40 | |
| | | JW7111S/ JW7111SA SOT23-6 | T _J = +25°C, VIN= 5.0V, Rlimit=10K, Load=1A | | 40 | 45 | |
| | | JW7111S/ JW7111SA DFN2X2-6 | T _J = +25°C, VIN= 5.0V, Rlimit=10K, Load=1A | | 40 | 45 | |
| Output Turn-On Rise Time | t _r | VIN= 5.5V, C _L = 1μF, R _{LOAD} = 100Ω. See Figure 1. | | | 1.1 | 1.5 | ms |
| | | VIN= 2.7V, C _L = 1μF, R _{LOAD} = 100Ω. | | | 0.7 | 1 | |
| Output Turn-Off Fall Time | t _f | VIN= 5.5V, C _L = 1μF, R _{LOAD} = 100Ω. See Figure 1. | | 90 | | 140 | us |
| | | VIN= 2.7V, C _L = 1μF, R _{LOAD} = 100Ω. | | 90 | | 140 | |

| Enable Pin | | | | | | | | |
|--|-----------------------|--|-----------------------------------|--------------|------|------|----|-----|
| Turn-On Time | t _{ON} | CL = 1μF, RL = 100Ω. See Figure 1. | | | | 3 | ms | |
| Turn-Off Time | t _{OFF} | CL = 1μF, RL = 100Ω. See Figure 1. | | | | 1 | ms | |
| EN High-Level Input Voltage | V _{EN,H} | JW7115S/JW7115S-2.5/JW7115S-2/ JW7115S-1/ JW7111S | | 1.4 | | | V | |
| | | JW7115SA/JW7115SA-2.5/JW7115SA-2/ JW7115SA-1/JW7111SA | | 1.4 | | | | |
| EN Low-Level Input Voltage | V _{EN,L} | JW7115S/JW7115S-2.5/JW7115S-2/ JW7115S-1/ JW7111S | | | | 1 | | |
| | | JW7115SA/JW7115SA-2.5/JW7115SA-2/ JW7115SA-1/JW7111SA | | | | 0.7 | | |
| Output Discharge | | | | | | | | |
| Discharge Resistance ⁶⁾ | R _{DIS} | VIN= 5V, Disabled, I _{OUT} =1mA | | | | 75 | Ω | |
| Fault Flag | | | | | | | | |
| FAULT Output Low Voltage | V _{OL} | I _{FAULT} = 1mA | | | | 180 | mV | |
| FAULT Blanking and Latch Off Time(Over-Current) | t _{blank_OC} | Assertion or de-assertion due to over current | | | 5 | 7.5 | 10 | ms |
| FAULT Off Current | I _{FOH} | V _{FAULT} = 6V | | | | 1 | uA | |
| Current Limit | | | | | | | | |
| Current-Limit Threshold (maximum DC output current), V _{OUT} = VIN -0.5V | I _{LIMIT} | JW7115S/ JW7115SA | -40°C ≤ TA ≤ +85°C | 3.05 | 3.3 | 3.6 | A | |
| | | JW7115S-2.5/ JW7115SA-2.5 | | 2.6 | 2.85 | 3.1 | | |
| | | JW7115S-2/ JW7115SA-2 | | 2.05 | 2.2 | 2.35 | | |
| | | JW7115S-1/ JW7115SA-1 | | 1.1 | 1.3 | 1.5 | | |
| | | JW7111S/ JW7111SA | R _{LIM} = 10kΩ | -40°C ~+85°C | 2.2 | 2.4 | | 2.6 |
| | | | R _{LIM} = 15kΩ | -40°C ~+85°C | 1.4 | 1.6 | | 1.8 |
| | | | R _{LIM} = 20kΩ | -40°C ~+85°C | 1.0 | 1.2 | | 1.4 |
| | | | R _{LIM} = 50kΩ | -40°C ~+85°C | 0.45 | 0.55 | | 0.7 |
| I _{LIMIT} Shorted to GND | | | 2.2 | 2.4 | 2.6 | | | |
| Short-Circuit Fold-back Current Limit ⁶⁾ | I _{SHORT} | JW7115Sx/ JW7111Sx | V _{OUT} Connected to GND | | | 0.6 | A | |

| | | | | | | |
|--|-----------------------|--|----|------|-----|----|
| Short-Circuit Response Time ⁶⁾ | t _{SHORT} | V _{OUT} = 0V to I _{OUT} = I _{LIMIT} (V _{OUT} shorted to ground). See Figure 2. | | 2 | | μs |
| <i>Reverse Voltage Protection</i> | | | | | | |
| Reverse-Voltage Comparator Trip Point | V _{RVP} | V _{OUT} - V _{IN} | 90 | 135 | 190 | mV |
| Reverse Current Limit | I _{ROCP} | V _{OUT} - V _{IN} = 200mV | | 0.72 | | A |
| <i>Thermal Shutdown</i> | | | | | | |
| Thermal Shutdown Threshold ⁶⁾ | T _{SHDN} | Enabled, R _{LOAD} = 1KΩ | | 160 | | °C |
| Thermal Shutdown Threshold under Current Limit ⁶⁾ | T _{SHDN_OCP} | Enabled, R _{LOAD} = 1KΩ | | 140 | | °C |
| Thermal Shutdown Hysteresis ⁶⁾ | T _{HYS} | | | 20 | | °C |

Note:

- 4) Pulse-testing techniques maintain junction temperature close to ambient temperature; thermal effects must be taken into account separately.
- 5) The discharge function is active when the device is disabled (when enable is de-asserted or during power-up power-down when V_{IN} < V_{UVLO}). The discharge function offers a resistive discharge path for the external storage capacitor for limited time.
- 6) Guaranteed by design

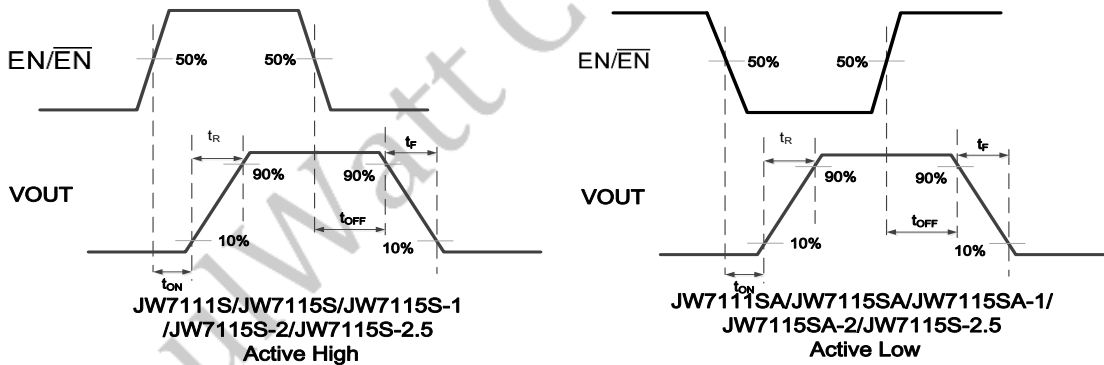

Figure 1 Voltage Waveforms

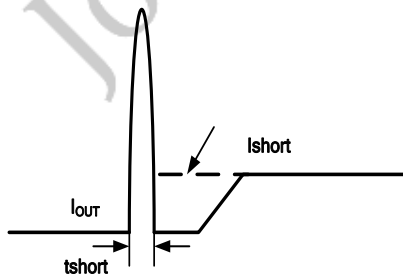
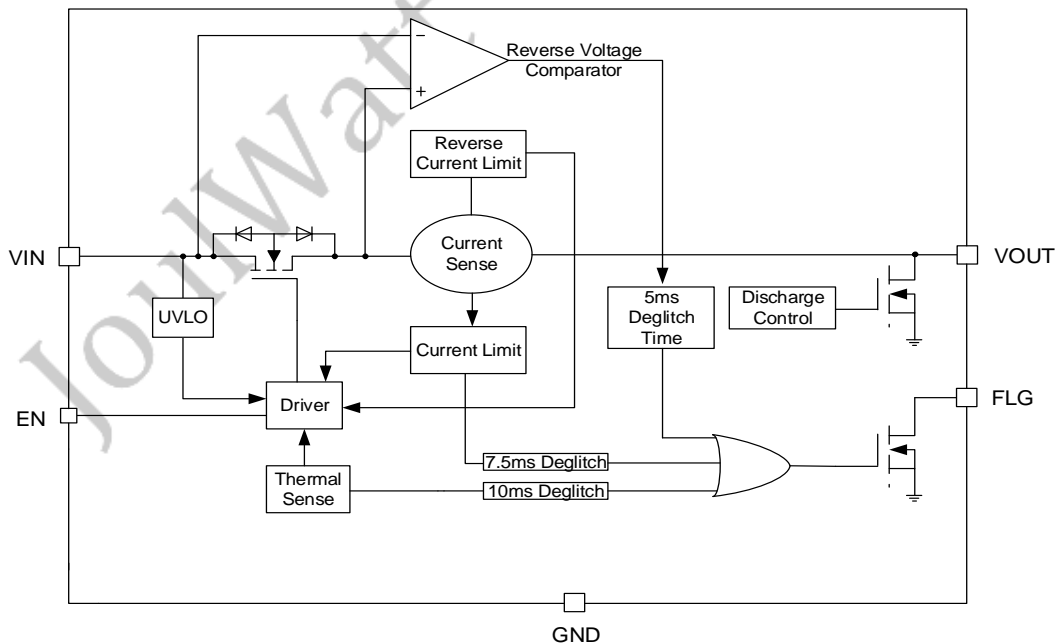

Figure 2 Response Time to Short Circuit Waveform

PIN DESCRIPTION

| Pin | | | | Name | Description |
|---------|----------|---------|----------|----------------------------|--|
| SOT23-5 | TSOT23-5 | SOT23-6 | DFN2X2-6 | | |
| 1 | 1 | 6 | 1 | VOUT | Output voltage |
| 2 | 2 | 2 | 5 | GND | Ground(0V) |
| 3 | 3 | 4 | 3 | FLG | Active-low open-drain output, asserted during over-current, over-temperature. |
| 4 | 4 | 3 | 4 | EN/ $\overline{\text{EN}}$ | Enable input |
| | | | | | JW7115S/JW7115S-1/JW7115S-2/JW7115S-2.5/JW7111S: logic high turns on power switch. |
| | | | | | JW7115SA/JW7115SA-1/JW7115SA-2/JW7115SA-2.5/JW7111SA: logic low turns on power switch. |
| 5 | 5 | 1 | 6 | VIN | Input, connect a 10 μ F or greater ceramic capacitor from VIN to GND as close to IC as possible. |
| - | | 5 | 2 | ILIM | Use external resistor to set current-limit threshold; Recommended 10k Ω \leq R _{LIM} \leq 49.9k Ω . |

BLOCK DIAGRAM



JW7115Sx Block Diagram

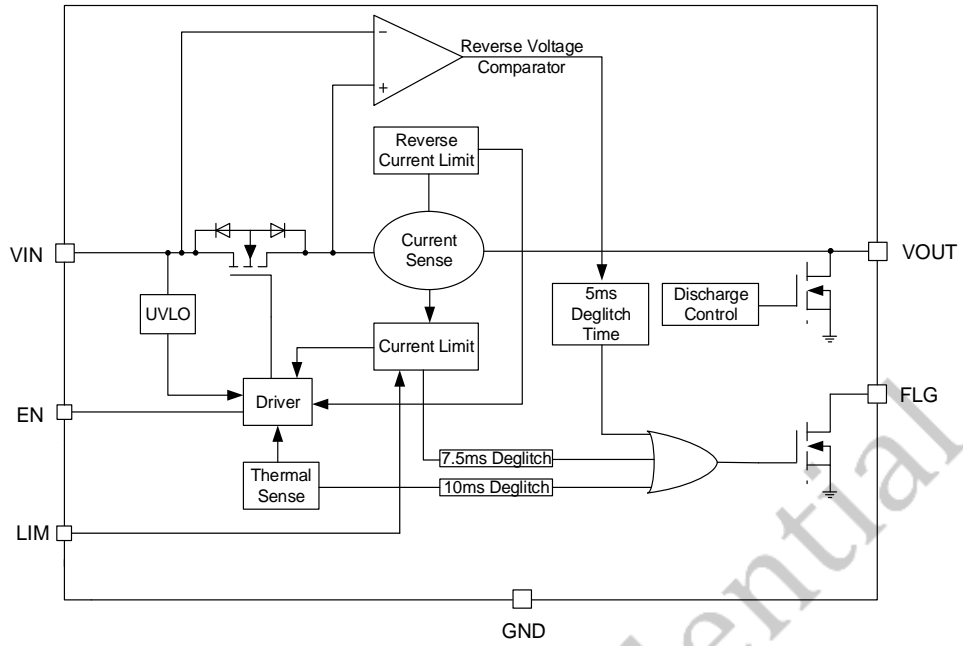

JW7111Sx Block Diagram

JoulWatt Confidential

TYPICAL PERFORMANCE CHARACTERISTICS OF JW7115S-1

Vin =5V, Vout =5V, Cin=10uF, Cout = 10µF, TA = +25°C, unless otherwise noted

Startup through Enable

VIN=5V, Vout=5V
Iout=0A

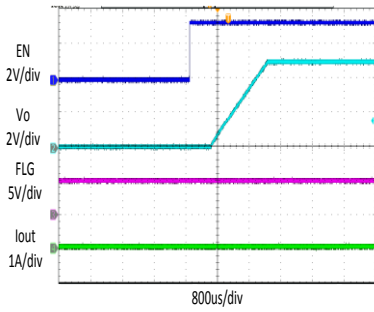

Shutdown through Enable

VIN=5V, Vout=5V
Iout=0A(Resistive load)

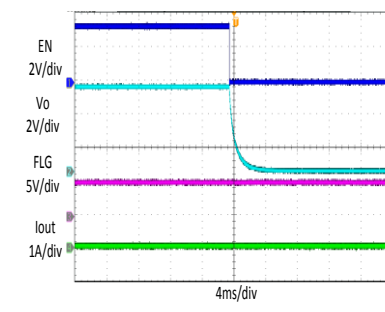

Startup through Enable

VIN=5V, Vout=5V
Iout=1A (Resistive load)

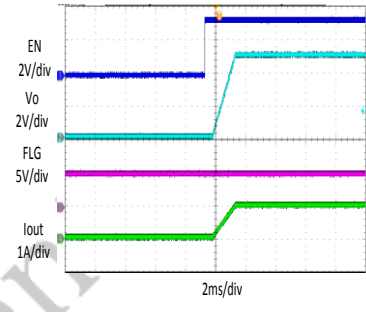

Shutdown through Enable

VIN=5V, Vout=5V
Iout=1A (Resistive load)

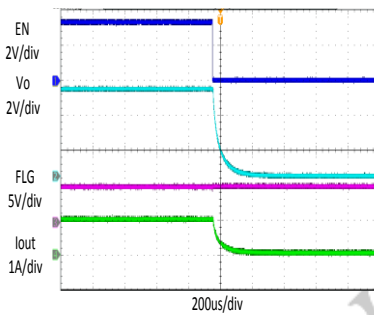

Over Current Protection

VIN=5V, Vout=5V
Iout=0A to 1.4A

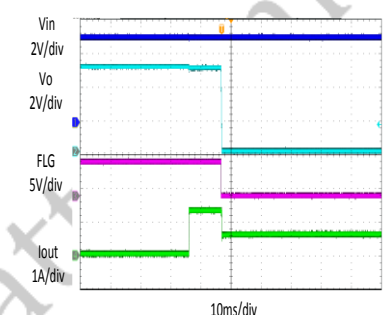

Over Current Recovery

VIN=5V, Vout=5V
Iout=1.4A to 0A

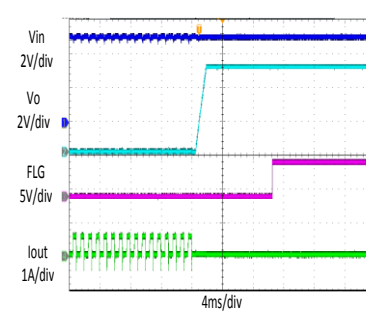

Short Circuit Protection

VIN=5V, Vout=5V
Iout=0A to short

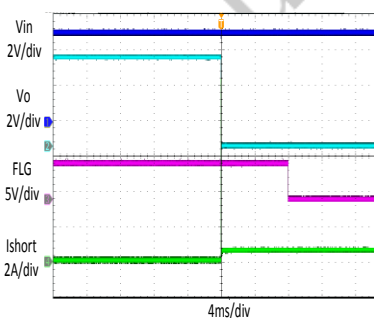

Short Circuit Recovery

VIN=5V, Vout=5V
Iout=Short to 0A

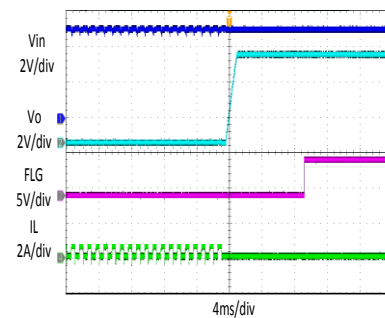

Reverse Current Protection

VIN=5V, Vout=5V to 6.2V
1A input sinking current

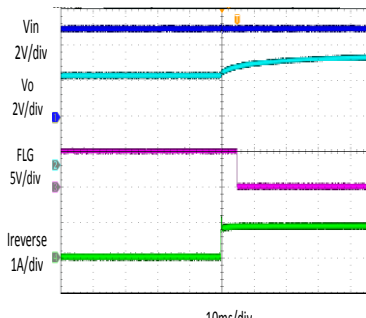

TYPICAL PERFORMANCE CHARACTERISTICS OF JW7115S-2

Vin =5V, Vout =5V, Cin=10uF, Cout = 10μF, TA = +25°C, unless otherwise noted

Startup through Enable

VIN=5V, Vout=5V
Iout=0A

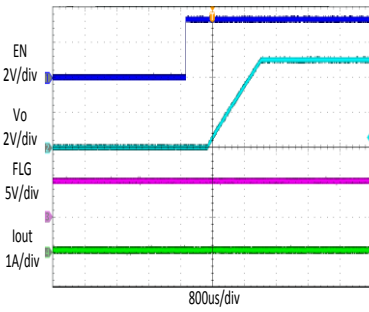

Shutdown through Enable

VIN=5V, Vout=5V
Iout=0A(Resistive load)

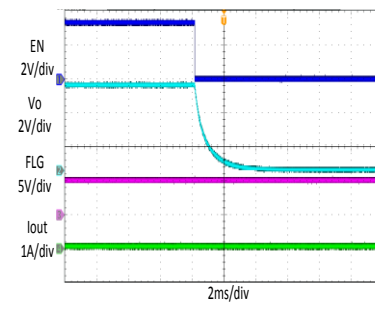

Startup through Enable

VIN=5V, Vout=5V
Iout=2A (Resistive load)

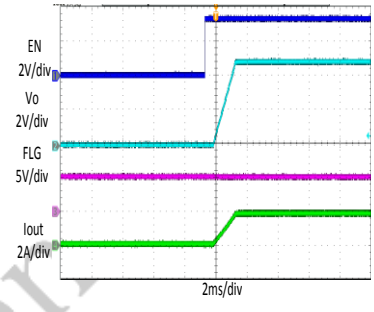

Shutdown through Enable

VIN=5V, Vout=5V
Iout=2A (Resistive load)

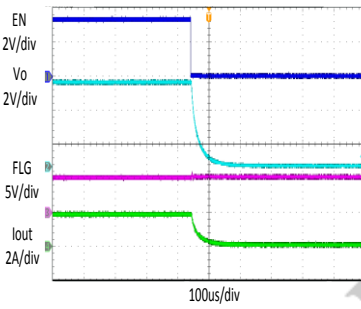

Over Current Protection

VIN=5V, Vout=5V
Iout=0A to 2.2A

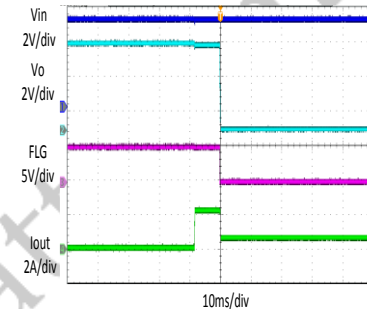

Over Current Recovery

VIN=5V, Vout=5V
Iout=2.2A to 0A

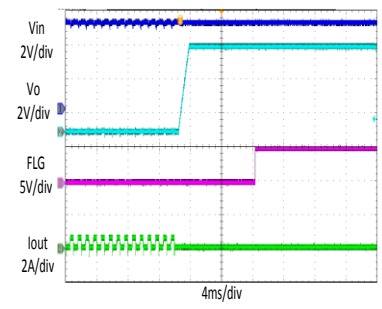

Short Circuit Protection

VIN=5V, Vout=5V
Iout=0A to short

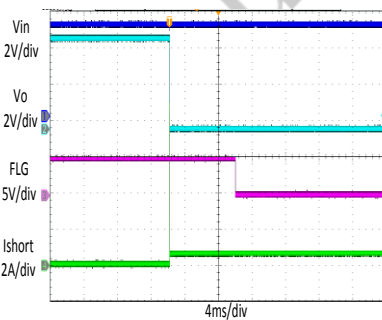

Short Circuit Recovery

VIN=5V, Vout=5V
Iout=Short to 0A

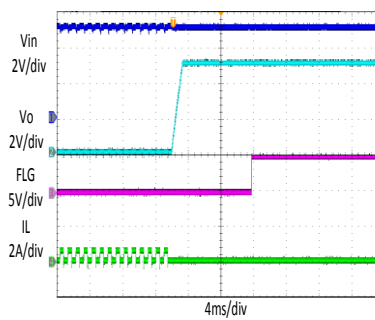

Reverse Current Protection

VIN=5V, Vout=5V to 6.2V
1A input sinking current

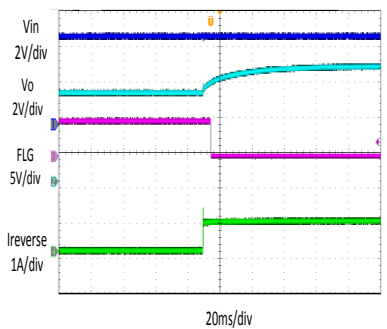

TYPICAL PERFORMANCE CHARACTERISTICS OF JW7115S

Vin =5V, Vout =5V, Cin=10uF, Cout = 10µF, TA = +25°C, unless otherwise noted

Startup through Enable

VIN=5V, Vout=5V
Iout=0A

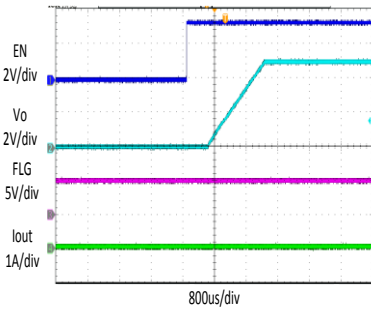

Shutdown through Enable

VIN=5V, Vout=5V
Iout=0A(Resistive load)

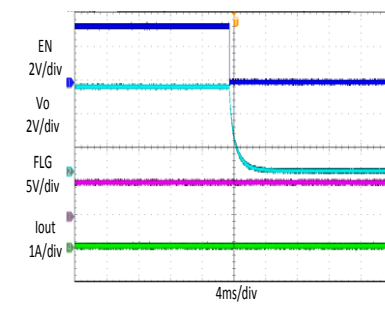

Startup through Enable

VIN=5V, Vout=5V
Iout=3A (Resistive load)

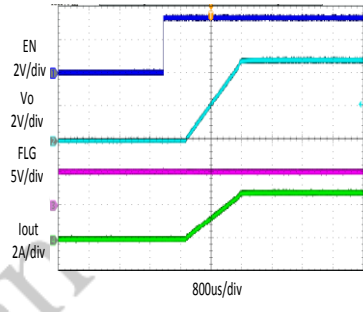

Shutdown through Enable

VIN=5V, Vout=5V
Iout=3A (Resistive load)

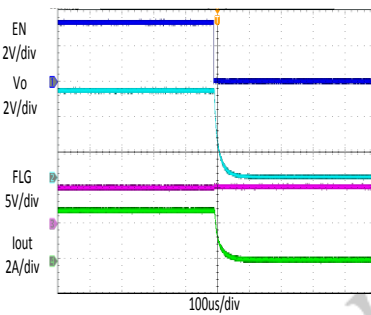

Over Current Protection

VIN=5V, Vout=5V
Iout=0A to 3.3A

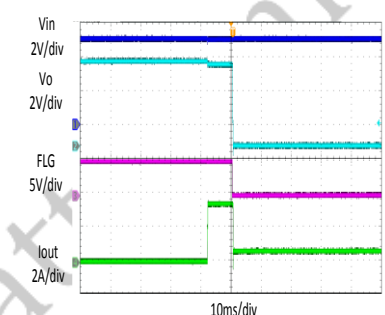

Over Current Recovery

VIN=5V, Vout=5V
Iout=3.3A to 0A

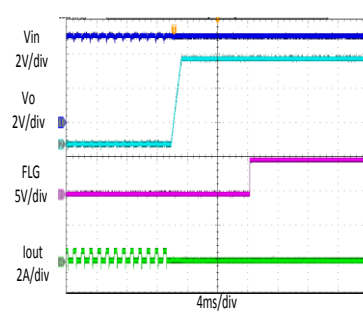

Short Circuit Protection

VIN=5V, Vout=5V
Iout=0A to short

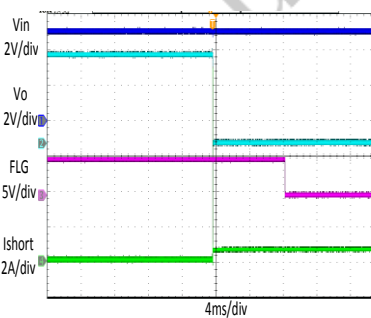

Short Circuit Recovery

VIN=5V, Vout=5V
Iout=Short to 0A

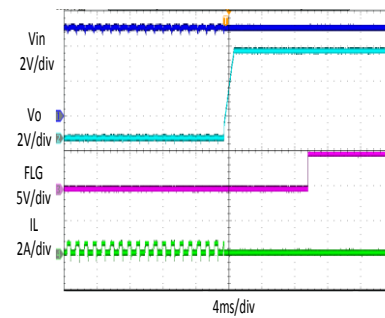

Reverse Current Protection

VIN=5V, Vout=5V to 6.2V
1A input sinking current

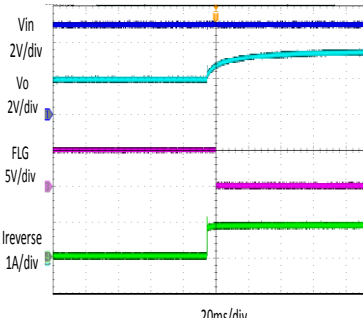

TYPICAL PERFORMANCE CHARACTERISTICS OF JW7115SA-2.5

Vin =5V, Vout =5V, Cin=10uF, Cout = 10μF, TA = +25°C, unless otherwise noted

Startup through Enable

VIN=5V, Vout=5V
Iout=0A

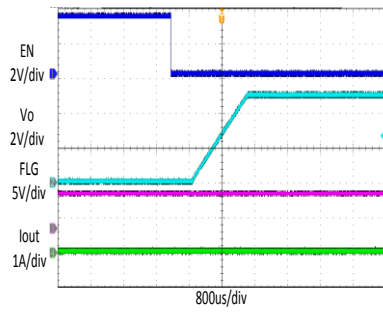

Shutdown through Enable

VIN=5V, Vout=5V
Iout=0A(Resistive load)

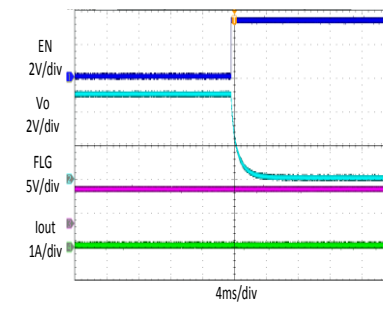

Startup through Enable

VIN=5V, Vout=5V
Iout=2.5A (Resistive load)

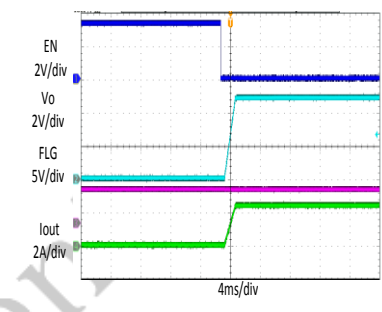

Shutdown through Enable

VIN=5V, Vout=5V
Iout=2.5A (Resistive load)

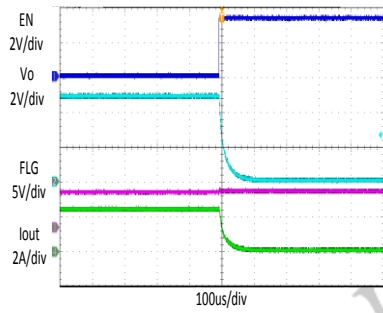

Over Current Protection

VIN=5V, Vout=5V
Iout=0A to 2.7A

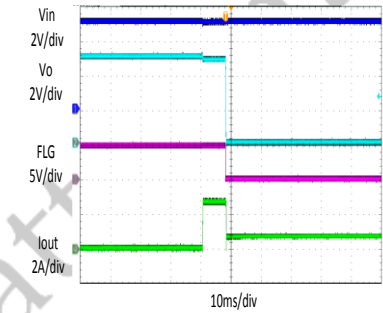

Over Current Recovery

VIN=5V, Vout=5V
Iout=2.7A to 0A

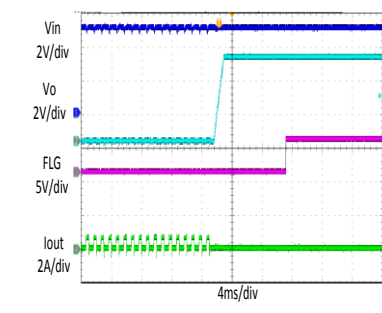

Short Circuit Protection

VIN=5V, Vout=5V
Iout=0A to short

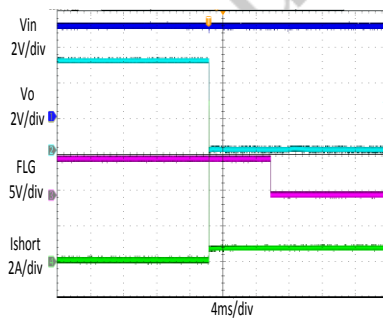

Short Circuit Recovery

VIN=5V, Vout=5V
Iout=Short to 0A

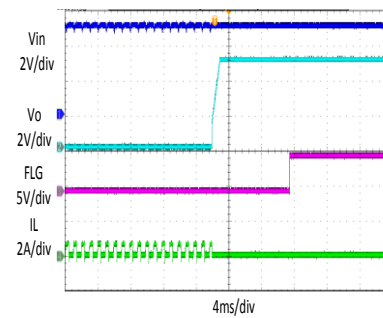

Reverse Current Protection

VIN=5V, Vout=5V to 6.2V
1A input sinking current

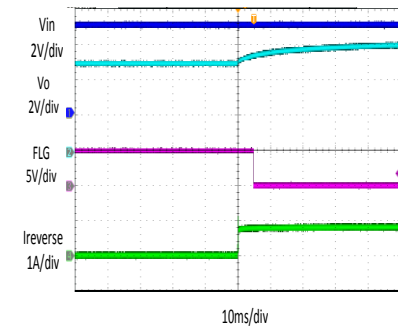

TYPICAL PERFORMANCE CHARACTERISTICS OF JW7115Sx Series

Vin =2.7V to 5.5V, Cin=10uF, Cout = 10μF, TA = +25°C, unless otherwise noted

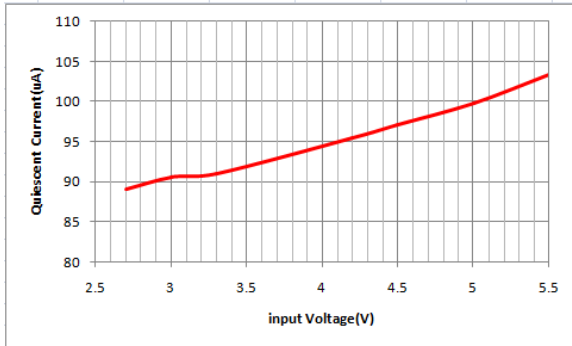

Figure 1. Quiescent Current VS Input Voltage
(Vin=2.7V to 5.5V, EN=3.3V, Iout=0A)

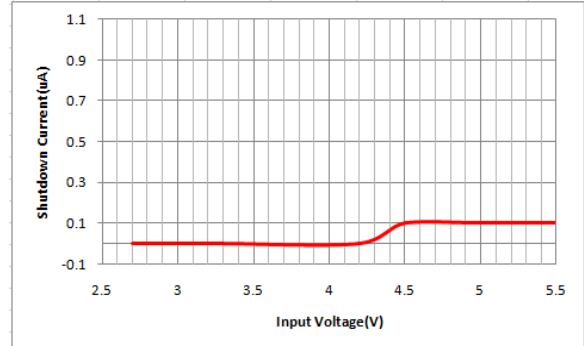

Figure 2. Shutdown Current VS Input Voltage
(Vin=2.7V to 5.5V, EN=0V, Iout=0A)

JoulWatt Confidential

FUNCTIONAL DESCRIPTION

The JW7115Sx/JW7111Sx integrates high-side MOSFET optimized for Universal Serial Bus (USB) that requires protection functions. The MOSFET is driven with controlled gate voltage and slew-rate, which makes this USB device ideal for hot-swap or hot-plug applications.

Discharge Function

When enable is de-asserted, or when the input voltage is under UVLO level, the discharge function is active. The output capacitor is discharged through an internal NMOS in series with a 75Ω resistor. The discharge time is dependent on the RC time constant of the resistance and output capacitance.

FAULT Response

The Fault Flag function is realized by an open-drain circuit. The output goes active low for any of following faults: current limit threshold, short-circuit current limit, reverse current limit threshold, or thermal shutdown. In order to avoid the mis-trigger, a 7.5ms deglitch timer is inserted when an overcurrent or short circuit fault condition occurs. The FLG output remains low until over-current, short-circuit current limit or over-temperature condition is removed.

Connecting a heavy capacitive load to the output of the device can cause a momentary over-current condition, which does not trigger the FAULT as long as the Fault condition lasts less than 7.5ms deglitch. This deglitch timer is also applied for over-current recovery and over-temperature recovery.

Power Supply Considerations

A local 10uF~22uF/0805/10V X7R or X5R ceramic capacitor between VIN and GND, close to the device, is requested if the input supply is located more than a few inches from the device. This local capacitor can absorb the spikes on VIN pin in

transient events, such as hot-plug, short-circuit, reverse-blocking. For most of conditions, 10uF/0805/10V is highly recommended for good safety.

Additionally, bypassing the device output with a 0.1μF to 4.7μF ceramic capacitor improves the immunity of the device to short-circuit condition.

This capacitor also prevents output from going negative during turn-off due to parasitic inductance. If the negative kick is less than -1V, a Scotty diode in parallel with VOUT pin is recommended. Otherwise, the device may go malfunction.

Generic Hot-Plug Applications

In many applications it is common to remove modules or PC boards while the main unit is still operating. These are considered hot-plug applications. Such implementations require the control of current surges. The most effective way to control the current surge is to limit and slowly ramp the current and voltage being applied to the card, similar to the Soft Start in which a power supply normally turns on. Due to the controlled rising and falling times of the switch, these devices can be used to provide a softer start-up to devices being hot-plugged into a powered system.

The UVLO feature also ensures that the switch is off after the card has been removed, and that the switch is off during the next insertion.

Under-Voltage Lockout (UVLO)

Whenever the input voltage falls below UVLO threshold (2.35V), the power switch is turned off. This facilitates the design of hot-insertion systems where it is not possible to turn off the power switch before input power is removed.

Over-Current and Short-Circuit Protection

An internal sensing FET is employed to sense

over-current conditions. Unlike current-sense resistors, sensing FETs do not increase the series resistance of the current path. When an overcurrent condition is detected, the switch maintains a constant output current and reduces the output voltage accordingly. Complete shutdown occurs only if the fault stays long enough to activate over-temperature protection.

Over-Current FAULT Signal

The FAULT signal will be asserted in response to OCP before the device reaches its current limit. The output current upon FAULT signal triggered will be lower than the limit value. To implement FAULT signal for precision system protection control, it is recommended to leave enough margin from maximum continuous operating current.

Current Limit Setting

The current limit of JW7111S/JW7111SA can be programmed by an external resistor. The current limit is proportional to the current sourced out of ILIM pin.

The recommended 1% resistor range for R_{LIM} is 10kΩ ≤ R_{LIM} ≤ 49.9kΩ. The traces routing the R_{LIM} resistor to the JW7111S/JW7111SA should be as short as possible to reduce parasitic effects on the current-limit accuracy.

To design a maximum current limit, find the intersection of R_{LIM} and the maximum desired load current. The typical current limit can be calculated by

$$I_{lim} = \frac{0.1}{R_{LIM}} \times 232.33 + 0.077$$

And also R_{LIM} can be calculated by

$$R_{lim} = \frac{23.233}{I_{Lim} - 0.077} (k\Omega)$$

Over-Temperature Protection

Thermal protection prevents the IC from damage when the die temperature exceeds safe margins. This mainly occurs when heavy-overload or short-circuit faults occurs. IC implements a thermal sensing circuit to monitor the operating junction temperature. Once the die temperature rises to approximately +160°C (+140°C in case the part is under current limit), the thermal protection feature activates as follows: The internal thermal sense circuitry turns the power switch off and the FLG output is asserted, thus preventing the power switch from damage. Once the junction temperature drops to 140°C, the MOSFET restart to work.

Reverse-Current Protection

The USB specification does not allow an output device to source current back into the USB port. In a normal MOSFET switch, current will flow in reverse direction (from the output side to the input side) when the output side voltage is higher than the input side. A reverse over-current protection (ROCP) is implemented in the JW7115SX to limit reverse current. The ROCP circuit is activated when the output voltage is higher than the input voltage. After the reverse current circuit has tripped (reached the reverse current trip threshold), the current is clamped at this I_{ROCP} level. Once ROCP is activated, FLG pin pulls down after a de-glitch time of 5ms. Recovery from ROCP is automatic when the fault is removed. FLG pin pulls higher after 5ms de-glitch time.

External Rlimit Suggestion

| Min Current Limit Value (A) | Theoretic Resistor Value (kΩ) | Selected Resistor Value (kΩ) 1% ot 0.1% | Typical OCP Target Value (A) | Maximum Current Limit Value (A) |
|-----------------------------|-------------------------------|---|------------------------------|---------------------------------|
| 0.5 | 44.4 | 44.2 | 0.60 | 0.75 |
| 0.6 | 36.1 | 35.7 | 0.73 | 0.89 |
| 0.7 | 30.4 | 30.1 | 0.85 | 1.02 |
| 0.8 | 26.3 | 26.1 | 0.97 | 1.15 |
| 0.9 | 23.2 | 23.2 | 1.08 | 1.27 |
| 1 | 20.7 | 20.5 | 1.21 | 1.41 |
| 1.1 | 19.0 | 18.7 | 1.32 | 1.52 |
| 1.2 | 17.6 | 17.4 | 1.41 | 1.61 |
| 1.3 | 16.3 | 16.2 | 1.51 | 1.71 |
| 1.4 | 15.3 | 15 | 1.63 | 1.83 |
| 1.5 | 14.3 | 14.3 | 1.70 | 1.90 |
| 1.6 | 13.5 | 13.3 | 1.82 | 2.02 |
| 1.7 | 12.7 | 12.7 | 1.91 | 2.11 |
| 1.8 | 12.1 | 12.1 | 2.00 | 2.20 |
| 1.9 | 11.5 | 11.5 | 2.10 | 2.30 |
| 2 | 10.9 | 10.7 | 2.25 | 2.45 |
| 2.1 | 10.5 | 10.2 | 2.35 | 2.55 |
| 2.2 | 10.0 | 10 | 2.40 | 2.60 |

TAPE AND REEL INFORMATION

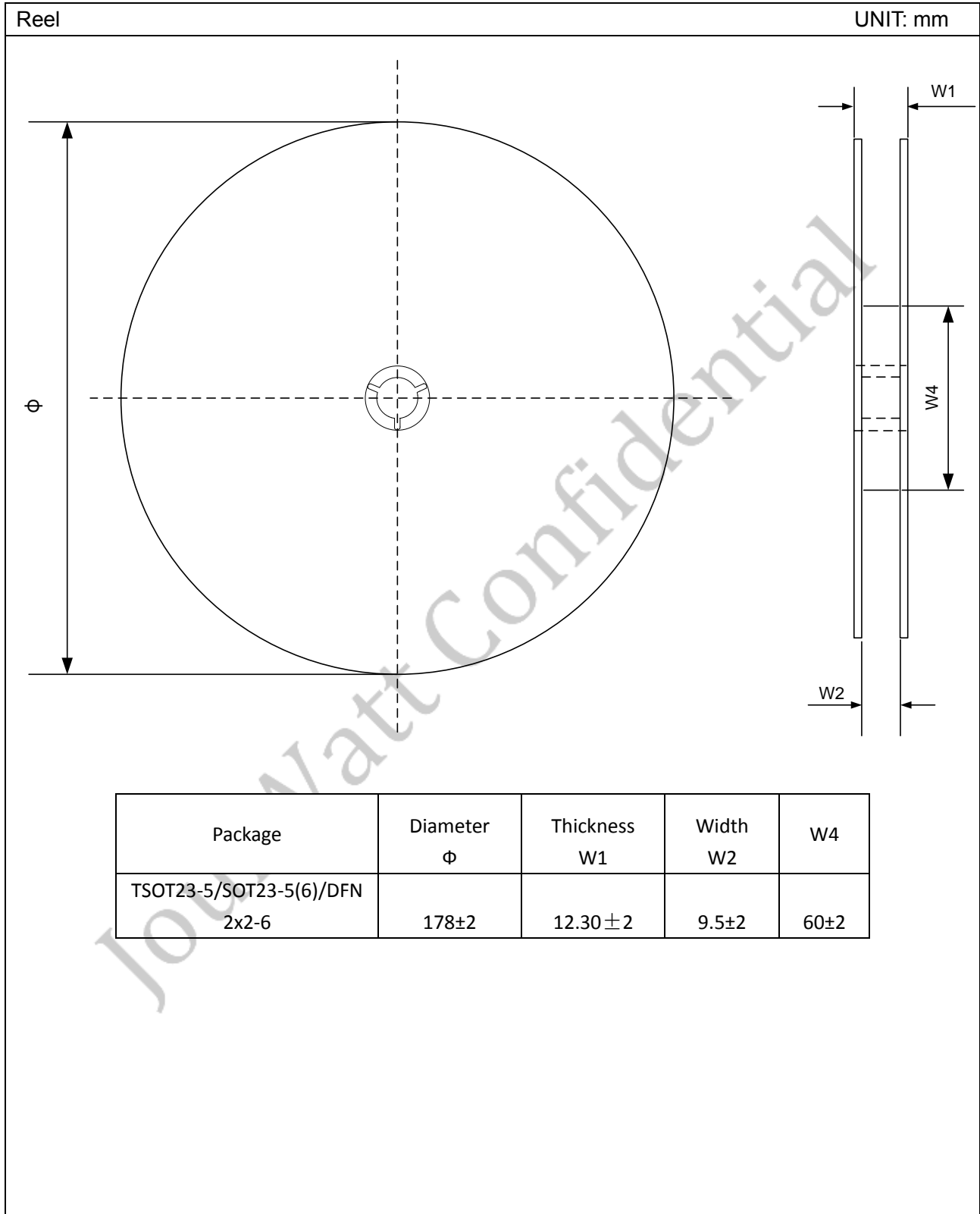

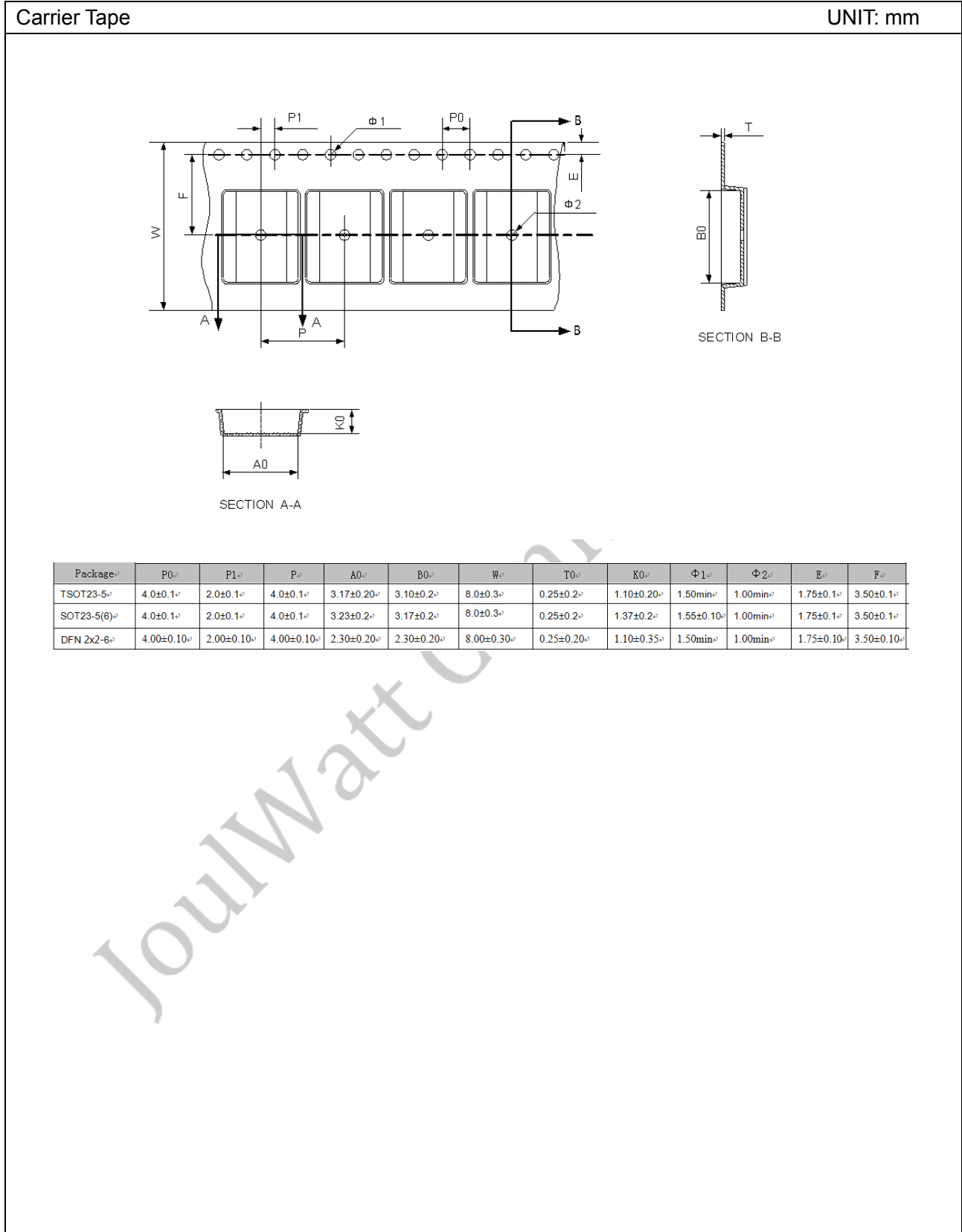

PACKAGE OUTLINE

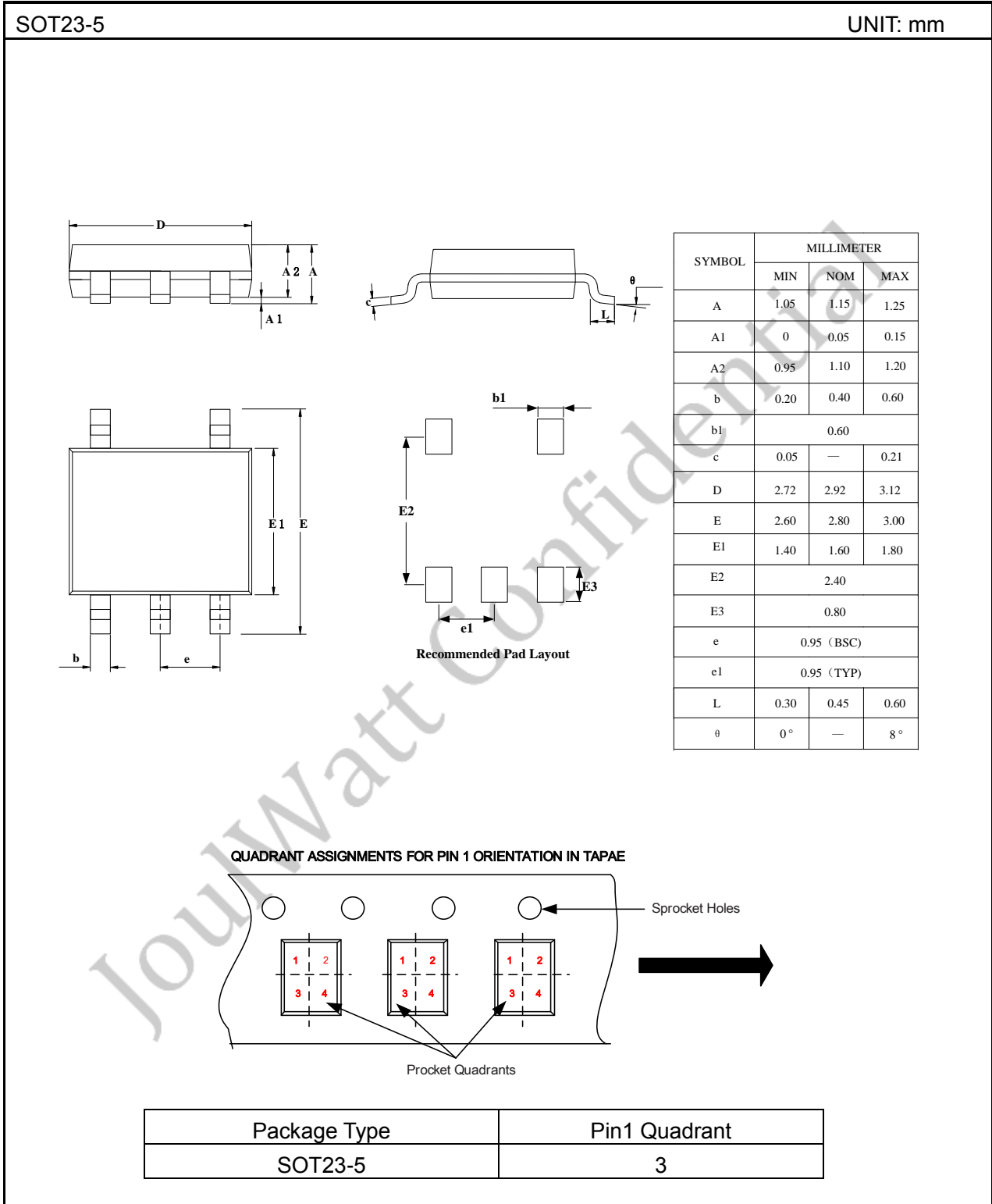

TSOT23-5

UNIT: mm

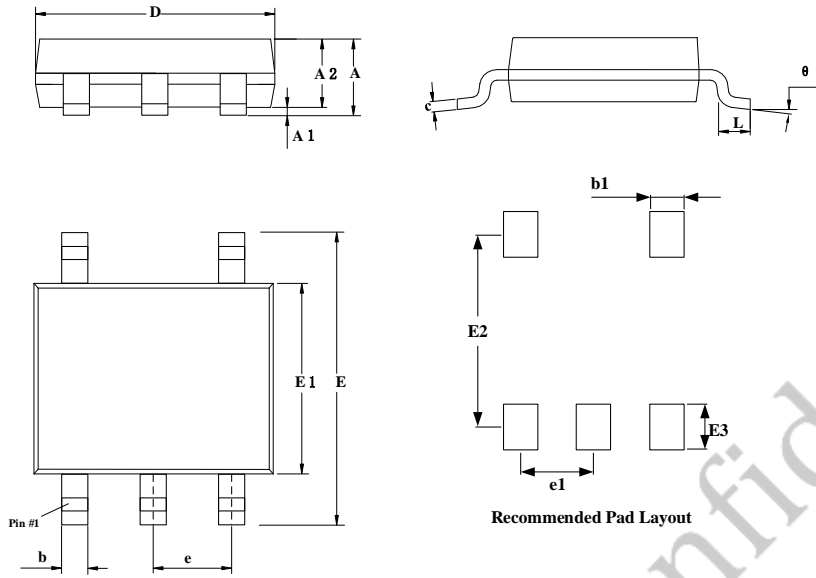

| SYMBOL | MILLIMETER | | |
|----------|------------|-------|------|
| | MIN | NOM | MAX |
| A | — | — | 1.00 |
| A1 | 0 | 0.05 | 0.10 |
| A2 | 0.84 | 0.872 | 0.90 |
| b | 0.30 | — | 0.50 |
| b1 | 0.60 | | |
| c | 0.08 | — | 0.20 |
| D | 2.72 | 2.92 | 3.12 |
| E | 2.60 | 2.80 | 3.00 |
| E1 | 1.50 | 1.65 | 1.75 |
| E2 | 2.45 | | |
| E3 | 0.80 | | |
| e | 0.95 (BSC) | | |
| e1 | 0.95 (TYP) | | |
| L | 0.30 | 0.45 | 0.60 |
| θ | 0° | — | 8° |

QUADRANT ASSIGNMENTS FOR PIN 1 ORIENTATION IN TAPAE

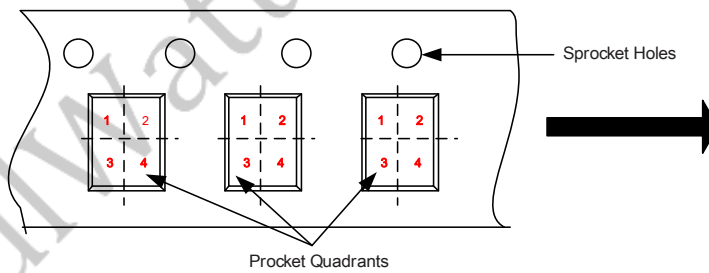

| Package Type | Pin1 Quadrant |
|--------------|---------------|
| TSOT23-5 | 3 |

SOT23-6

UNIT: mm

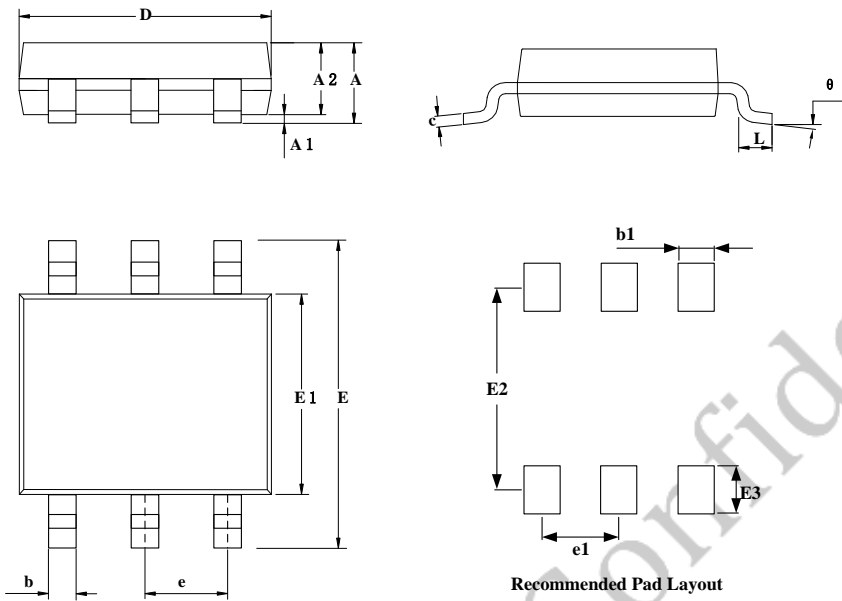

| SYMBOL | MILLIMETER | | |
|--------|------------|------|------|
| | MIN | NOM | MAX |
| A | 1.05 | 1.15 | 1.25 |
| A1 | 0 | 0.05 | 0.15 |
| A2 | 0.95 | 1.10 | 1.20 |
| b | 0.20 | 0.40 | 0.60 |
| b1 | 0.60 | | |
| c | 0.05 | — | 0.21 |
| D | 2.72 | 2.92 | 3.12 |
| E | 2.60 | 2.80 | 3.00 |
| E1 | 1.40 | 1.60 | 1.80 |
| E2 | 2.40 | | |
| E3 | 0.80 | | |
| e | 0.95 (BSC) | | |
| e1 | 0.95 (TYP) | | |
| L | 0.30 | 0.45 | 0.60 |
| theta | 0° | — | 8° |

QUADRANT ASSIGNMENTS FOR PIN 1 ORIENTATION IN TAPAE

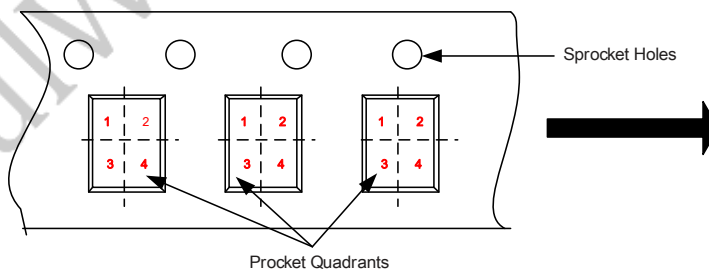

| Package Type | Pin1 Quadrant |
|--------------|---------------|
| SOT23-6 | 3 |

DFN2X2-6

UNIT: mm

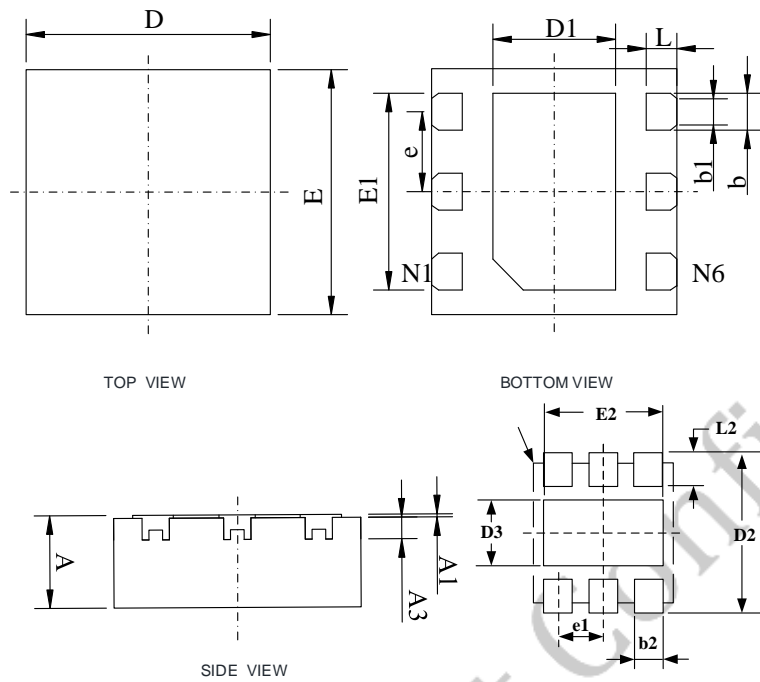

| SYMBOL | MILLIMETER | |
|--------|------------|-------|
| | MIN | MAX |
| A | 0.700 | 0.800 |
| A1 | 0.000 | 0.050 |
| A3 | 0.203 REF | |
| b | 0.250 | 0.350 |
| b1 | 0.220 REF | |
| D | 1.900 | 2.100 |
| E | 1.900 | 2.100 |
| D1 | 0.900 | 1.100 |
| E1 | 1.500 | 1.700 |
| e | 0.650 BSC | |
| L | 0.174 | 0.326 |
| E2 | 1.70 | |
| D3 | 1.00 | |
| D2 | 2.30 | |
| b2 | 0.40 | |
| e1 | 0.65 | |
| L2 | 0.47 | |

QUADRANT ASSIGNMENTS FOR PIN 1 ORIENTATION IN TAPAE

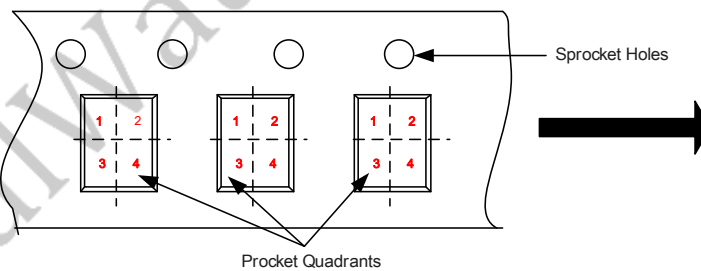

| Package Type | Pin1 Quadrant |
|--------------|---------------|
| DFN2X2-6 | 1 |

IMPORTANT NOTICE

- Joulwatt Technology Inc. reserves the right to make modifications, enhancements, improvements, corrections or other changes without further notice to this document and any product described herein.
- Any unauthorized redistribution or copy of this document for any purpose is strictly forbidden.
- Joulwatt Technology Inc. does not warrant or accept any liability whatsoever in respect of any products purchased through unauthorized sales channel.

JoulWatt Confidential

Copyright © 2018 JW7115Sx/JW7111Sx Incorporated.

All rights are reserved by Joulwatt Technology Inc.

X-ON Electronics

Largest Supplier of Electrical and Electronic Components

Click to view similar products for [Power Switch ICs - Power Distribution](#) category:

Click to view products by [JoulWatt](#) manufacturer:

Other Similar products are found below :

[TLE6232GP](#) [NCP45520IMNTWG-L](#) [FPF1018](#) [DS1222](#) [NCV380HMUAJAATBG](#) [TCK2065G,LF](#) [SZNCP3712ASNT3G](#)
[NCP45520IMNTWG-H](#) [VND5004ATR-E](#) [ITS5215LXT](#) [AP22811BW5-7](#) [SLG5NT1437VTR](#) [SZNCP3712ASNT1G](#) [DML1008LDS-7](#)
[KTS1640QGDV-TR](#) [KTS1641QGDV-TR](#) [NCV459MNWTBG](#) [NCP4545IMNTWG-L](#) [FPF2260ATMX](#) [SLG5NT1765V](#) [SLG5NT1757V](#)
[NCP45780IMN24RTWG](#) [AP2151AMP-13](#) [NCP45540IMNTWG-L](#) [TPS2022P](#) [FPF2495BUCX](#) [NCP45650IMNTWG](#) [NCV8412ADDR2G](#)
[DK5V100R20S](#) [JW7111SSOTB#TRPBF](#) [RY2121](#) [TPNTGD1100LT1G](#) [TPS27081ADDCR-TP](#) [FDC6331L-TP](#) [FDC6329L-TP](#) [FDC6323L-](#)
[TP](#) [SI3865DDV](#) [TPS2116DRLR](#) [U3213](#) [BTS7020-2EPA](#) [BTT6100-2ERA](#) [BTS71220-4ESA](#) [RS2588CYF5](#) [RS2580XTDE8](#) [LP5308B6F](#)
[ME1502AM5G](#) [MC33882PEP](#) [TPS2021IDRQ1](#) [TPS2104DBVR](#) [TPS22954DQCR](#)