

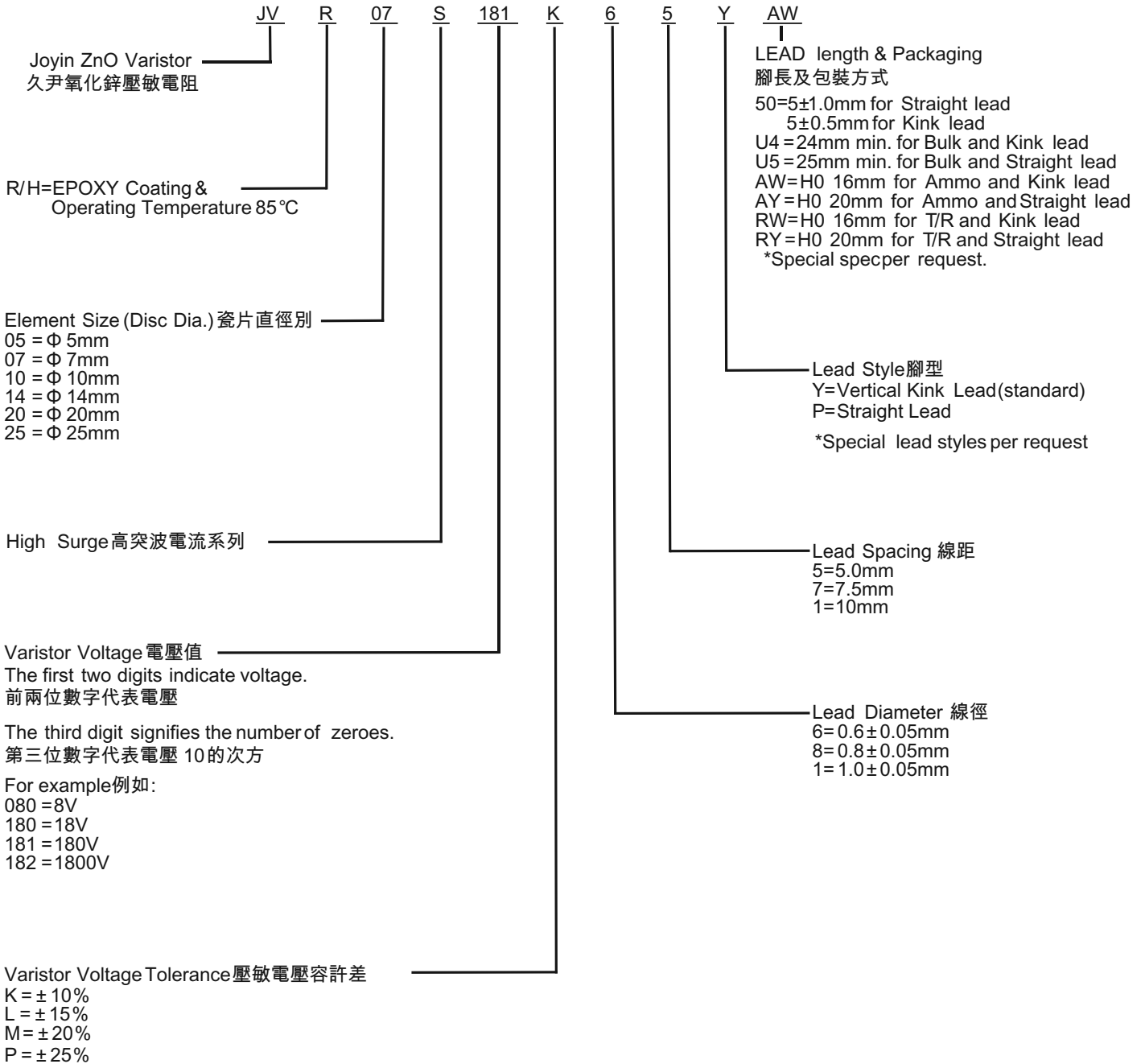

ORDERING CODE



過電壓保護

RATING AND CHARACTERISTICS

High Surge Varistors - 5mm

Part No.	Varistor Voltage at 0.1mA		Maximum Allowable Voltage		Maximum Clamping Voltage		Withstanding Surge Current (8/20us)	Nominal Discharge Current (8/20us)	Rated Wattage	Energy (10/1000us)	Certification		
	DC (V)	Tolerance	AC rms (V)	DC (V)	V@ ic (V)	ic (A)					1 Time (A)	In (KA)	(W)
JVR 05S 180M	18	±20%	11	14	40	1	250	0.1	0.01	0.7	★	★	★
JVR 05S 220L	22	±15%	14	18	48	1	250	0.1	0.01	0.8	★	★	★
JVR 05S 270K	27	±10%	17	22	60	1	250	0.1	0.01	1.1	★	★	★
JVR 05S 330K	33	±10%	20	26	73	1	250	0.1	0.01	1.3	★	★	★
JVR 05S 390K	39	±10%	25	31	86	1	250	0.1	0.01	1.5	★	★	★
JVR 05S 470K	47	±10%	30	38	104	1	250	0.1	0.01	1.8	★	★	★
JVR 05S 560K	56	±10%	35	45	123	1	250	0.1	0.01	2.2	★	★	★
JVR 05S 680K	68	±10%	40	56	150	1	250	0.1	0.01	2.6	★	★	★
JVR 05S 820K	82	±10%	50	65	145	5	800	0.1	0.1	3.5	★	★	★
JVR 05S 101K	100	±10%	60	85	175	5	800	0.1	0.1	4.5	★	★	★
JVR 05S 121K	120	±10%	75	100	210	5	800	0.1	0.1	5.5	★	★	★
JVR 05S 151K	150	±10%	95	125	260	5	800	0.1	0.1	6.5	★	★	★
JVR 05S 181K	180	±10%	115	150	320	5	800	0.1	0.1	8.0	★	★	★
JVR 05S 201K	200	±10%	130	170	355	5	800	0.1	0.1	8.5	★	★	★
JVR 05S 221K	220	±10%	140	180	380	5	800	0.1	0.1	9.0	★	★	★
JVR 05S 241K	240	±10%	150	200	415	5	800	0.1	0.1	10.5	★	★	★
JVR 05S 271K	270	±10%	175	225	475	5	800	0.1	0.1	11	★	★	★
JVR 05S 301K	300	±10%	195	250	525	5	800	0.1	0.1	12.0	★	★	★
JVR 05S 331K	330	±10%	210	275	575	5	800	0.1	0.1	13	★	★	★
JVR 05S 361K	360	±10%	230	300	620	5	800	0.1	0.1	16	★	★	★
JVR 05S 391K	390	±10%	250	320	675	5	800	0.1	0.1	17	★	★	★
JVR 05S 431K	430	±10%	275	350	745	5	800	0.1	0.1	20	★	★	★
JVR 05S 471K	470	±10%	300	385	810	5	800	0.1	0.1	21	★	★	★
JVR 05S 511K	510	±10%	320	418	880	5	800	0.1	0.1	22	★	★	★
JVR 05S 561K	560	±10%	350	460	940	5	800	0.1	0.1	25	★	★	★
JVR 05S 621K	620	±10%	385	505	1050	5	800	0.1	0.1	27	★	★	★
JVR 05S 681K	680	±10%	420	560	1150	5	800	0.1	0.1	28	★	★	★
JVR 05S 751K	750	±10%	460	615	1290	5	800	0.1	0.1	29	★	★	★

Application notes for UL ,CSA,VDE and CQC reconized related standards

Standard NO.	UL	CUL	VDE			CQC	
	UL 1449 4 TH Edition	CSA 22.2 No. 269.5	IEC61051-1 IEC61051-2 IEC61051-2-2	IEC61051-1 IEC61051-2 IEC61051-2-2 IEC60950-1:2013AnnexQ IEC62368-1:2014/G.8.2	GB/T1093-1997 GB/T10194-1997	GB4943.1-2011 GB/T1093-1997 GB/T10194-1997 GB8898-2011	
Title	Transient Voltage Surge Suppressors	Transient Voltage Surge Suppressors	Varistors for use in electronic equipment			Engaged in Voluntary Product Certification	
Certificate No.	VZCA2.E325508	VZCA8.E325508	40004658			CQC07001019159/9161/9162/9163/9164	
Symbols	☆		★	★	★	★	♻️



Pulse Life time Ratings-5mm

05S 180M-05S 680K

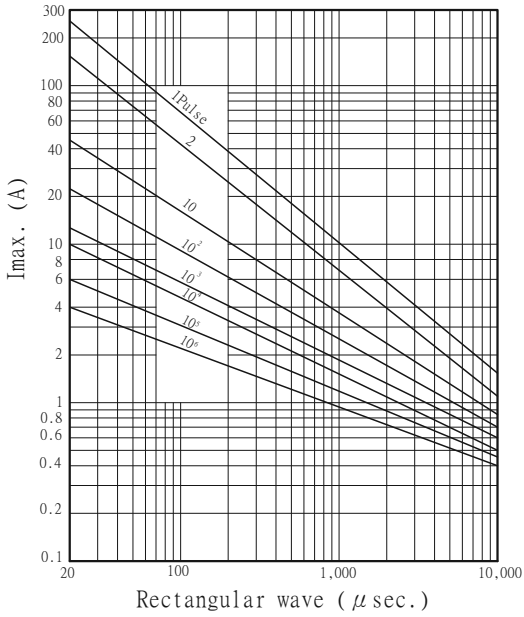

V-I Characteristic Curve-5mm

05S 180M-05S 680K

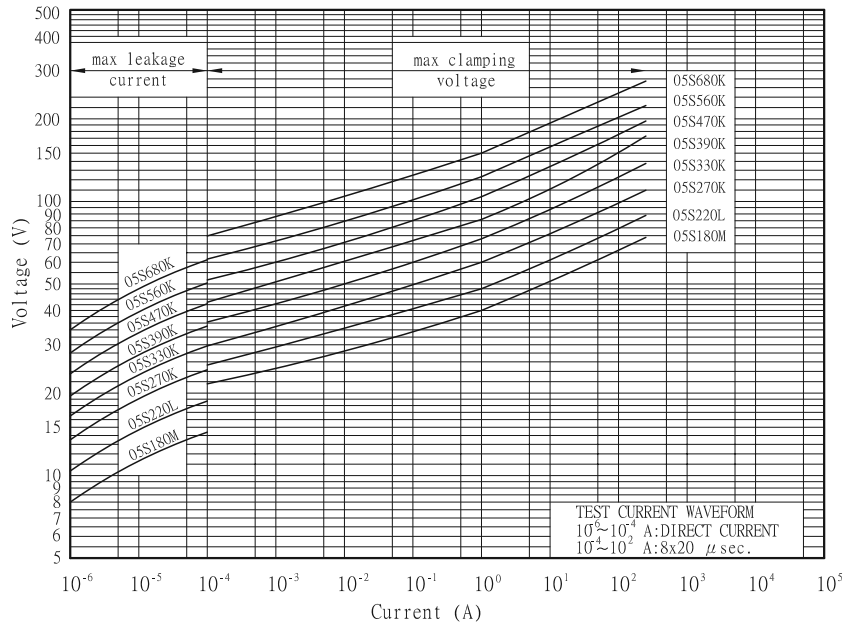

過電壓保護

05S 820K-05S 751K

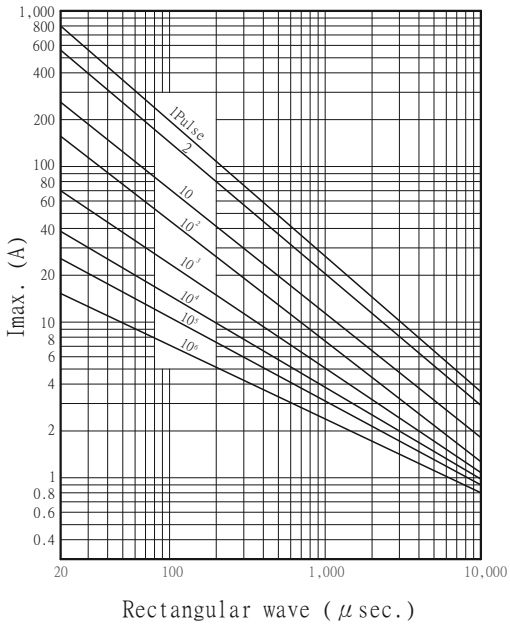

05S 820K-05S 751K

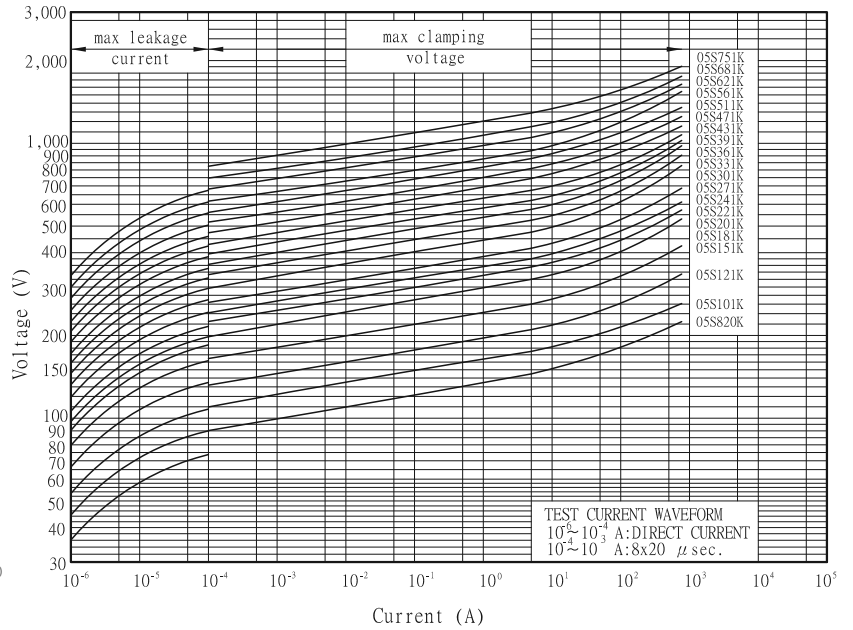

RATING AND CHARACTERISTICS

High Surge Varistors - 7mm

Part No.	Varistor Voltage at 1mA		Maximum Allowable Voltage		Maximum Clamping Voltage		Withstanding Surge Current (8/20us)	Nominal Discharge Current (8/20us)	Rated Wattage (W)	Energy (10/1000us) (J)	Certification
	DC (V)	Tolerance	AC rms (V)	DC (V)	V@ ic (V)	ic (A)					
JVR 07S 180M	18	±20%	11	14	40	2.5	500	0.2	0.02	1.5	★ ★ ★
JVR 07S 220L	22	±15%	14	18	48	2.5	500	0.2	0.02	1.7	★ ★ ★
JVR 07S 270K	27	±10%	17	22	60	2.5	500	0.2	0.02	2.1	★ ★ ★
JVR 07S 330K	33	±10%	20	26	73	2.5	500	0.2	0.02	2.8	★ ★ ★
JVR 07S 390K	39	±10%	25	31	86	2.5	500	0.2	0.02	3.0	★ ★ ★
JVR 07S 470K	47	±10%	30	38	104	2.5	500	0.2	0.02	3.8	★ ★ ★
JVR 07S 560K	56	±10%	35	45	123	2.5	500	0.2	0.02	4.4	★ ★ ★
JVR 07S 680K	68	±10%	40	56	150	2.5	500	0.2	0.02	5.4	★ ★ ★
JVR 07S 820K	82	±10%	50	65	145	10	1750	1.0	0.25	7.0	★ ★ ★
JVR 07S 101K	100	±10%	60	85	175	10	1750	1.0	0.25	9.0	★ ★ ★
JVR 07S 121K	120	±10%	75	100	210	10	1750	1.0	0.25	11.0	★ ★ ★
JVR 07S 151K	150	±10%	95	125	260	10	1750	1.0	0.25	13.0	★ ★ ★
JVR 07S 181K	180	±10%	115	150	320	10	1750	1.0	0.25	16.0	★ ★ ★
JVR 07S 201K	200	±10%	130	170	355	10	1750	1.0	0.25	17.5	★ ★ ★
JVR 07S 221K	220	±10%	140	180	380	10	1750	1.0	0.25	19.0	★ ★ ★
JVR 07S 241K	240	±10%	150	200	415	10	1750	1.0	0.25	21.0	★ ★ ★
JVR 07S 271K	270	±10%	175	225	475	10	1750	1.0	0.25	24	★ ★ ★
JVR 07S 301K	300	±10%	195	250	525	10	1750	1.0	0.25	26.0	★ ★ ★
JVR 07S 331K	330	±10%	210	275	575	10	1750	1.0	0.25	28	★ ★ ★
JVR 07S 361K	360	±10%	230	300	620	10	1750	1.0	0.25	32	★ ★ ★
JVR 07S 391K	390	±10%	250	320	675	10	1750	1.0	0.25	35	★ ★ ★
JVR 07S 431K	430	±10%	275	350	745	10	1750	1.0	0.25	40	★ ★ ★
JVR 07S 471K	470	±10%	300	385	810	10	1750	1.0	0.25	42	★ ★ ★
JVR 07S 511K	510	±10%	320	418	880	10	1750	1.0	0.25	45	★ ★ ★
JVR 07S 561K	560	±10%	350	460	940	10	1750	1.0	0.25	51	★ ★ ★
JVR 07S 621K	620	±10%	385	505	1050	10	1750	1.0	0.25	54	★ ★ ★
JVR 07S 681K	680	±10%	420	560	1150	10	1750	1.0	0.25	56	★ ★ ★
JVR 07S 751K	750	±10%	460	615	1290	10	1750	1.0	0.25	58	★ ★ ★
JVR 07S 781k	780	±10%	485	640	1290	10	1750	1.0	0.25	59	★ ★ ★
JVR 07S 821k	820	±10%	510	670	1355	10	1750	1.0	0.25	60	★ ★ ★



Pulse Life time Ratings-7mm
07S 180M-07S 680K

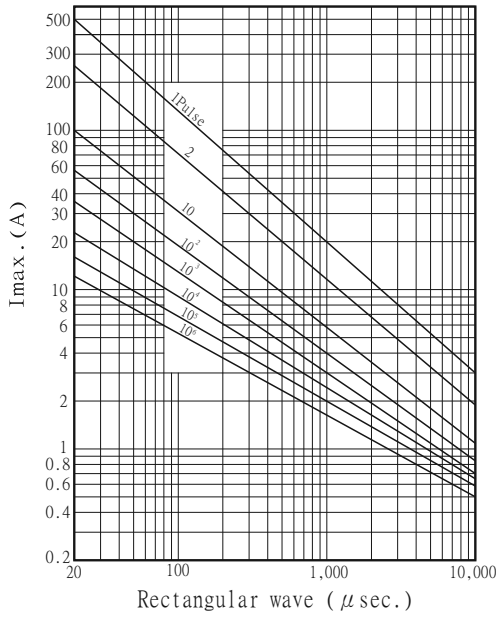

V-I Characteristic Curve-7mm
07S 180M-07S 680K

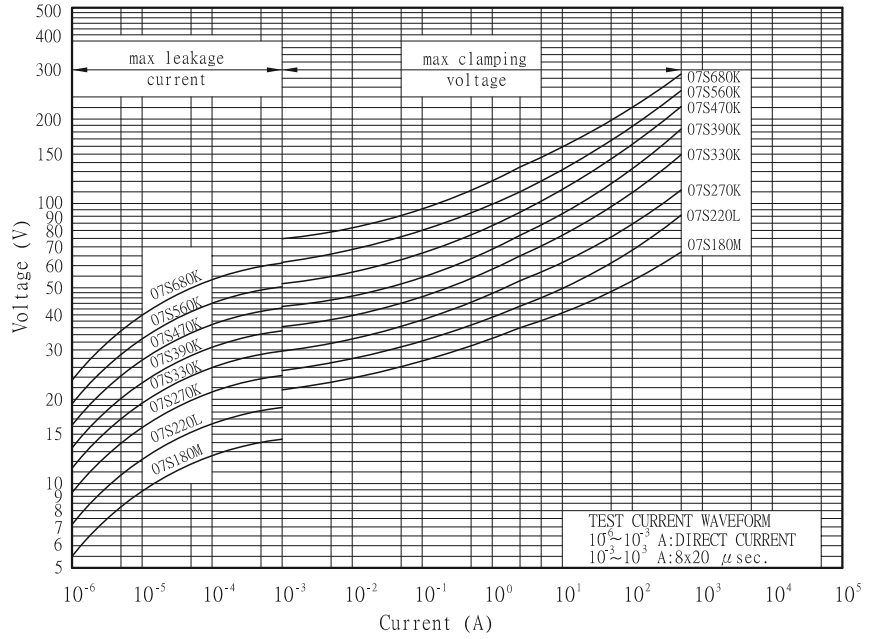

07S 820K-07S 821K

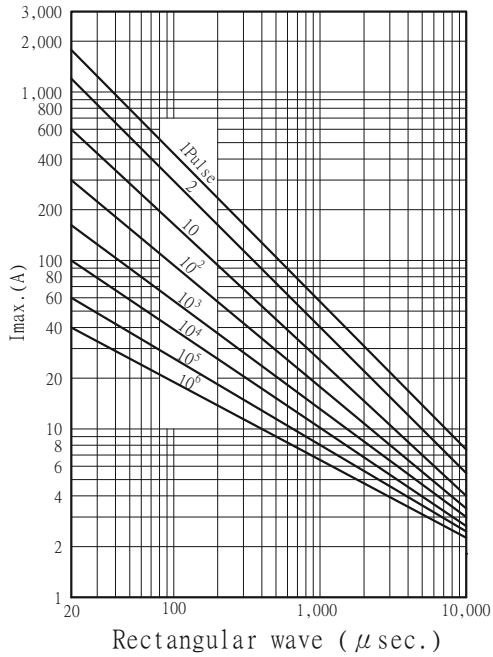

07S 820K-07S 821K

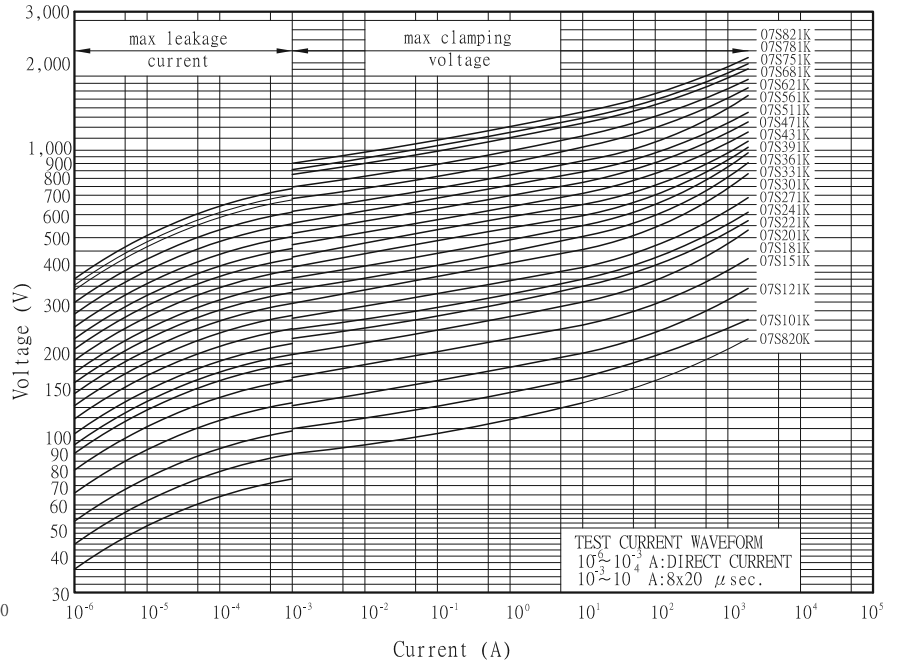

過電壓保護

RATING AND CHARACTERISTICS

High Surge Varistors - 10mm

Part No.	Varistor Voltage at 1mA		Maximum Allowable Voltage		Maximum Clamping Voltage		Withstanding Surge Current (8/20us)	Nominal Discharge Current (8/20us)	Rated Wattage	Energy (10/1000us)	Certification		
	DC (V)	Tolerance	AC rms (V)	DC (V)	V@ic (V)	ic (A)	1 Time (A)	In (KA)	(W)	(J)	UL	us	CEC
JVR 10S 180M	18	±20%	11	14	36	5	1000	0.75	0.05	2.6	★	★	★
JVR 10S 220L	22	±15%	14	18	43	5	1000	0.75	0.05	3.2	★	★	★
JVR 10S 270K	27	±10%	17	22	53	5	1000	0.75	0.05	3.9	★	★	★
JVR 10S 330K	33	±10%	20	26	65	5	1000	0.75	0.05	4.8	★	★	★
JVR 10S 390K	39	±10%	25	31	77	5	1000	0.75	0.05	5.6	★	★	★
JVR 10S 470K	47	±10%	30	38	93	5	1000	0.75	0.05	6.8	★	★	★
JVR 10S 560K	56	±10%	35	45	110	5	1000	0.75	0.05	8.1	★	★	★
JVR 10S 680K	68	±10%	40	56	135	5	1000	0.75	0.05	9.8	★	★	★
JVR 10S 820K	82	±10%	50	65	135	25	3500	1.5	0.4	14.0	★	★	★
JVR 10S 101K	100	±10%	60	85	165	25	3500	1.5	0.4	18.0	★	★	★
JVR 10S 121K	120	±10%	75	100	200	25	3500	1.5	0.4	22.0	★	★	★
JVR 10S 151K	150	±10%	95	125	250	25	3500	1.5	0.4	25.0	★	★	★
JVR 10S 181K	180	±10%	115	150	300	25	3500	3.0	0.4	32.0	★	★	★
JVR 10S 201K	200	±10%	130	170	340	25	3500	3.0	0.4	35.0	★	★	★
JVR 10S 221K	220	±10%	140	180	360	25	3500	3.0	0.4	39.0	★	★	★
JVR 10S 241K	240	±10%	150	200	395	25	3500	3.0	0.4	42.0	★	★	★
JVR 10S 271K	270	±10%	175	225	455	25	3500	3.0	0.4	49	★	★	★
JVR 10S 301K	300	±10%	195	250	505	25	3500	3.0	0.4	52.0	★	★	★
JVR 10S 331K	330	±10%	210	275	550	25	3500	3.0	0.4	58	★	★	★
JVR 10S 361K	360	±10%	230	300	595	25	3500	3.0	0.4	65	★	★	★
JVR 10S 391K	390	±10%	250	320	650	25	3500	3.0	0.4	70	★	★	★
JVR 10S 431K	430	±10%	275	350	710	25	3500	3.0	0.4	80	★	★	★
JVR 10S 471K	470	±10%	300	385	775	25	3500	3.0	0.4	85	★	★	★
JVR 10S 511K	510	±10%	320	418	842	25	3500	3.0	0.4	92	★	★	★
JVR 10S 561K	560	±10%	350	460	920	25	3500	3.0	0.4	102	★	★	★
JVR 10S 621K	620	±10%	385	505	1025	25	3500	3.0	0.4	107	★	★	★
JVR 10S 681K	680	±10%	420	560	1120	25	3500	3.0	0.4	112	★	★	★
JVR 10S 751K	750	±10%	460	615	1240	25	3500	3.0	0.4	115	★	★	★
JVR 10S 781K	780	±10%	485	640	1290	25	3500	3.0	0.4	116	★	★	★
JVR 10S 821K	820	±10%	510	670	1355	25	3500	3.0	0.4	118	★	★	★
JVR 10S 911K	910	±10%	550	745	1500	25	3500	3.0	0.4	127	★	★	★
JVR 10S 102K	1000	±10%	625	825	1650	25	3500	3.0	0.4	140	★	★	★
JVR 10S 112K	1100	±10%	680	895	1815	25	3500	3.0	0.4	155	★	★	★
JVR 10S 122K	1200	±10%	720	975	1980	25	3500	1.5	0.4	168	★	★	★
JVR 10S 142K	1400	±10%	825	1135	2310	25	3500	1.5	0.4	195	★	★	★
JVR 10S 162K	1600	±10%	920	1300	2640	25	3500	1.5	0.4	222	★	★	★
JVR 10S 182K	1800	±10%	1000	1465	2970	25	3500	1.5	0.4	247	★	★	★



Pulse Life time Ratings-10mm
10S 180M~10 S680K

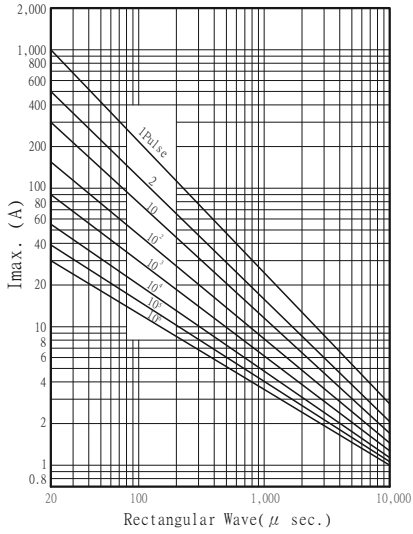

V-I Characteristic Curve-10mm
10S 180M~10 S680K

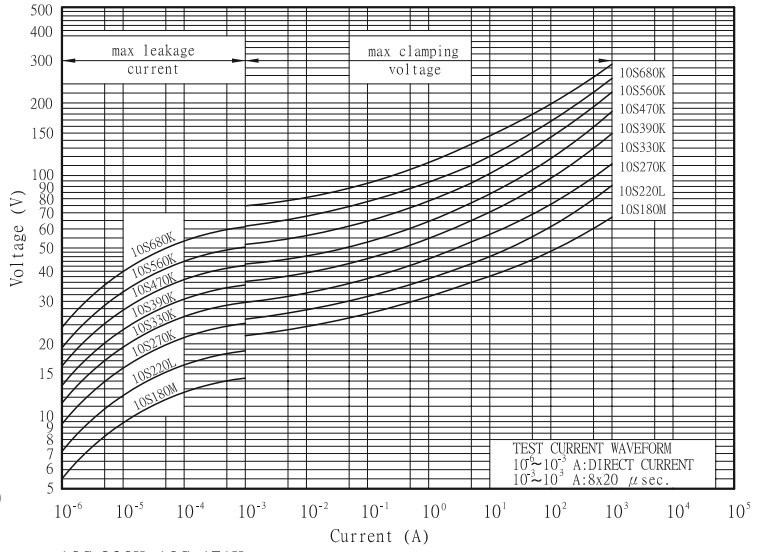

10S 820K~10S 471K

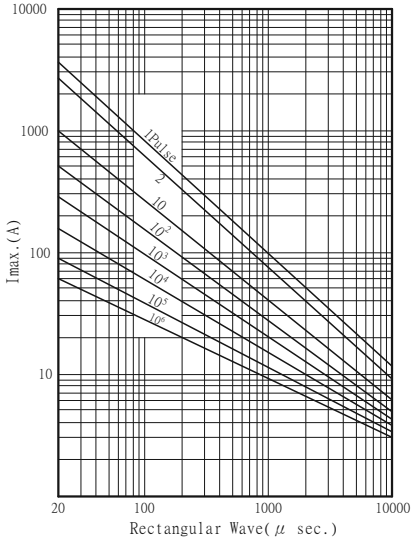

10S 820K~10S 471K

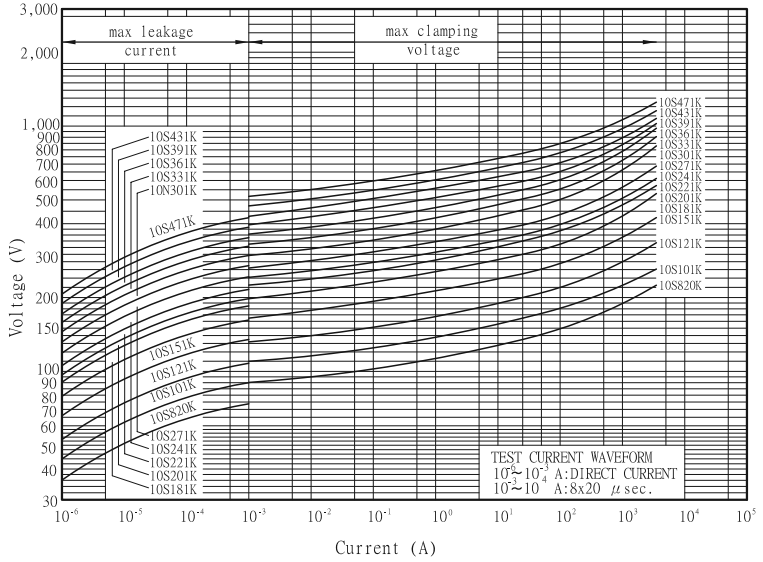

10S 511K~10S 182K

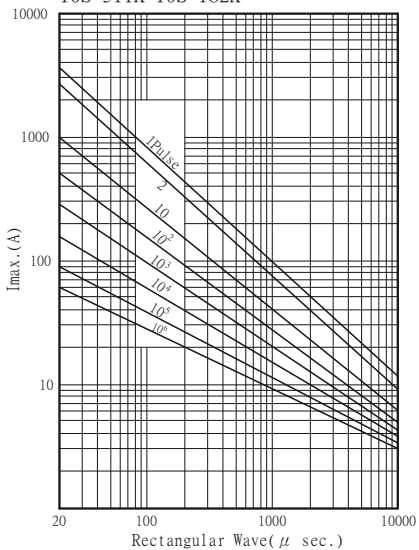

10S 511K~10S 182K

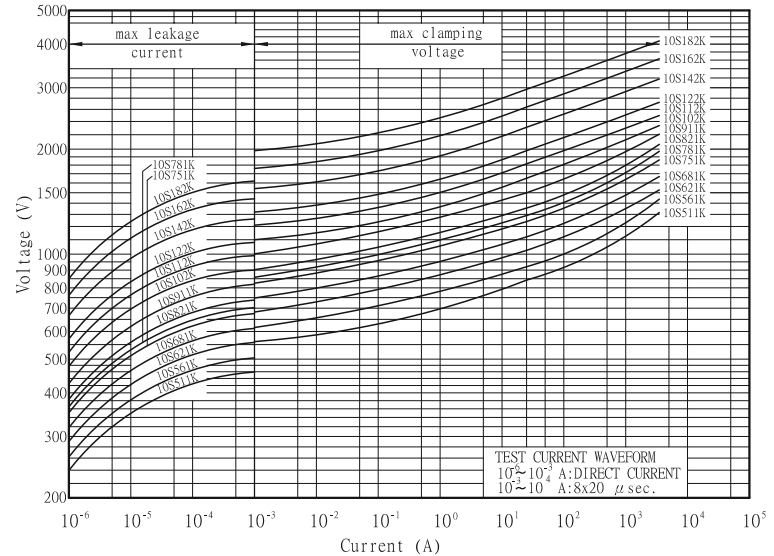

RATING AND CHARACTERISTICS

High Surge Varistors - 14mm

Part No.	Varistor Voltage at 1mA		Maximum Allowable Voltage		Maximum Clamping Voltage		Withstanding Surge Current (8/20us)	Nominal Discharge Current (8/20us)	Rated Wattage	Energy (10/1000us)	Certification		
	DC (V)	Tolerance	AC rms (V)	DC (V)	V@ ic (V)	ic (A)	1 Time (A)	In (KA)	(W)	(J)	UL	us	CE
JVR 14S 180M	18	±20%	11	14	36	10	2000	1	0.1	5.2	★	★	★
JVR 14S 220L	22	±15%	14	18	43	10	2000	1	0.1	6.3	★	★	★
JVR 14S 270K	27	±10%	17	22	53	10	2000	1	0.1	7.8	★	★	★
JVR 14S 330K	33	±10%	20	26	65	10	2000	1	0.1	9.5	★	★	★
JVR 14S 390K	39	±10%	25	31	77	10	2000	1	0.1	11.0	★	★	★
JVR 14S 470K	47	±10%	30	38	93	10	2000	1	0.1	14.0	★	★	★
JVR 14S 560K	56	±10%	35	45	110	10	2000	1	0.1	16.0	★	★	★
JVR 14S 680K	68	±10%	40	56	135	10	2000	1	0.1	20.0	★	★	★
JVR 14S 820K	82	±10%	50	65	135	50	6000	3.0	0.6	28.0	★	★	★
JVR 14S 101K	100	±10%	60	85	165	50	6000	3.0	0.6	36.0	★	★	★
JVR 14S 121K	120	±10%	75	100	200	50	6000	3.0	0.6	44.0	★	★	★
JVR 14S 151K	150	±10%	95	125	250	50	6000	3.0	0.6	53.0	★	★	★
JVR 14S 181K	180	±10%	115	150	300	50	6000	3.0	0.6	65.0	★	★	★
JVR 14S 201K	200	±10%	130	170	340	50	6000	3.0	0.6	70.0	★	★	★
JVR 14S 221K	220	±10%	140	180	360	50	6000	3.0	0.6	78.0	★	★	★
JVR 14S 241K	240	±10%	150	200	395	50	6000	3.0	0.6	84.0	★	★	★
JVR 14S 271K	270	±10%	175	225	455	50	6000	3.0	0.6	99	★	★	★
JVR 14S 301K	300	±10%	195	250	505	50	6000	3.0	0.6	105.0	★	★	★
JVR 14S 331K	330	±10%	210	275	550	50	6000	3.0	0.6	115	★	★	★
JVR 14S 361K	360	±10%	230	300	595	50	6000	3.0	0.6	130	★	★	★
JVR 14S 391K	390	±10%	250	320	650	50	6000	3.0	0.6	140	★	★	★
JVR 14S 431K	430	±10%	275	350	710	50	6000	3.0	0.6	155	★	★	★
JVR 14S 471K	470	±10%	300	385	775	50	6000	3.0	0.6	175	★	★	★
JVR 14S 511K	510	±10%	320	418	842	50	6000	3.0	0.6	190	★	★	★
JVR 14S 561K	560	±10%	350	460	920	50	6000	3.0	0.6	205	★	★	★
JVR 14S 621K	620	±10%	385	505	1025	50	6000	3.0	0.6	215	★	★	★
JVR 14S 681K	680	±10%	420	560	1120	50	6000	3.0	0.6	225	★	★	★
JVR 14S 751K	750	±10%	460	615	1240	50	6000	3.0	0.6	230	★	★	★
JVR 14S 781K	780	±10%	485	640	1290	50	6000	3.0	0.6	233	★	★	★
JVR 14S 821K	820	±10%	510	670	1355	50	6000	3.0	0.6	235	★	★	★
JVR 14S 911K	910	±10%	550	745	1500	50	6000	3.0	0.6	255	★	★	★
JVR 14S 102K	1000	±10%	625	825	1650	50	6000	3.0	0.6	283	★	★	★
JVR 14S 112K	1100	±10%	680	895	1815	50	6000	3.0	0.6	310	★	★	★
JVR 14S 122K	1200	±10%	720	975	1980	50	6000	2.0	0.6	338	★	★	★
JVR 14S 142K	1400	±10%	825	1135	2310	50	6000	2.0	0.6	393	★	★	★
JVR 14S 162K	1600	±10%	920	1300	2640	50	6000	2.0	0.6	450	★	★	★
JVR 14S 182K	1800	±10%	1000	1465	2970	50	6000	2.0	0.6	510	★	★	★



Pulse Life time Ratings-14mm
14S 180M~14S 680K

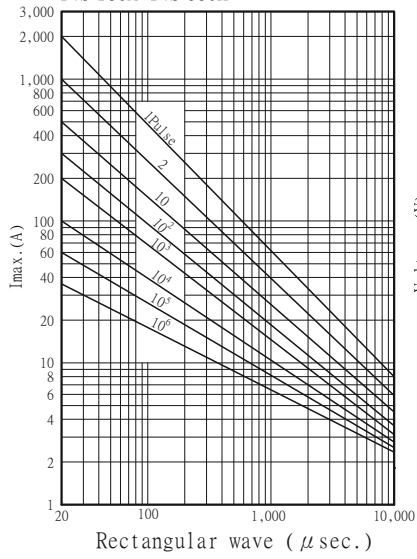

V-I Characteristic Curve-14mm
14S 180M~14S 680K

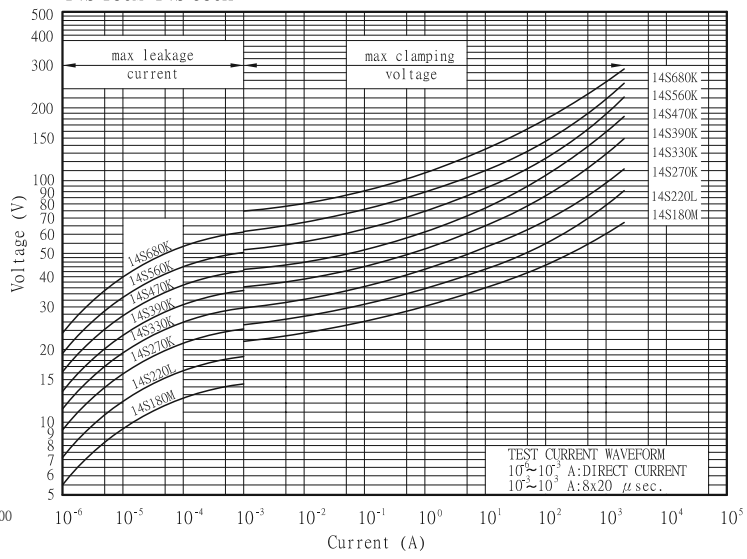

14S 820K~14S 471K

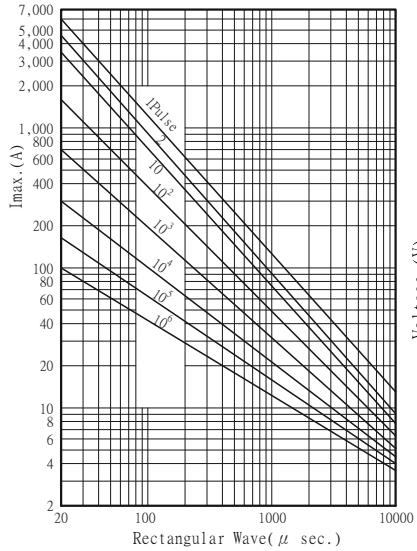

14S 820K~14S 471K

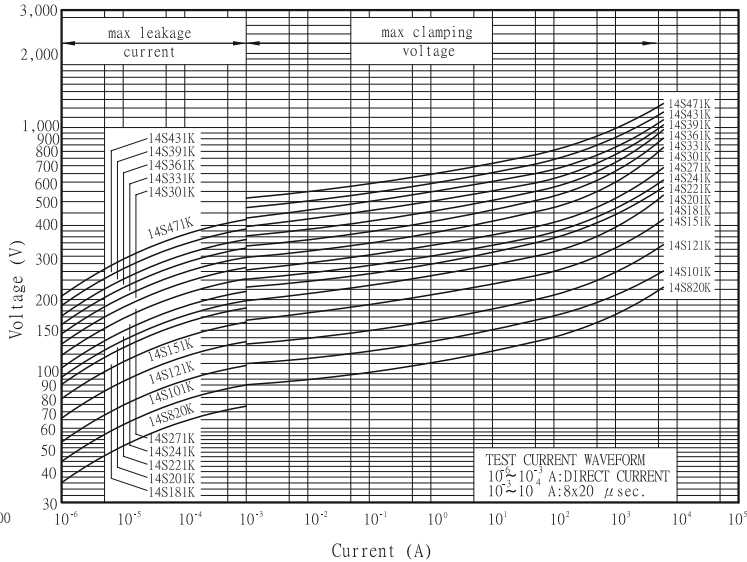

14S 511K~14S 182K

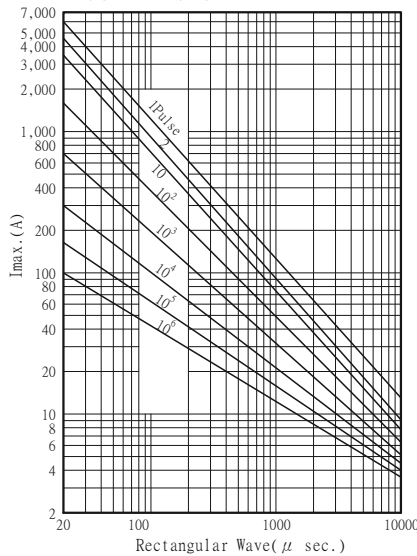

14S 511K~14S 182K

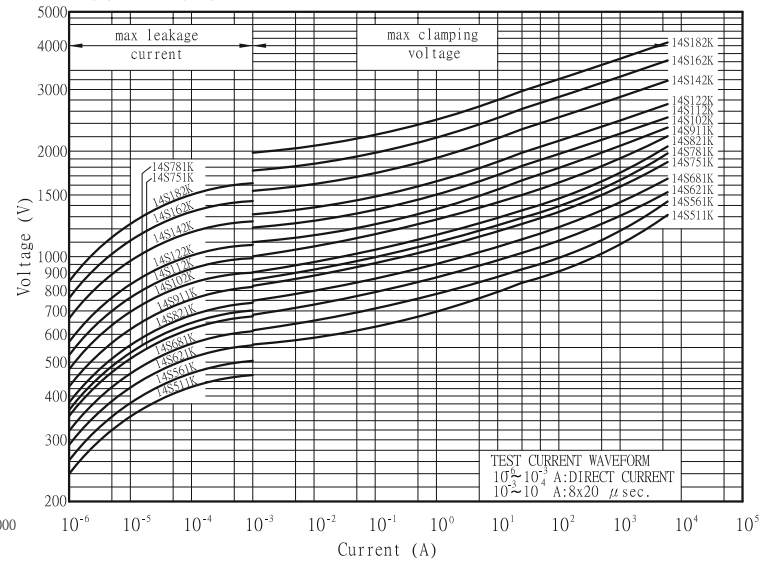

RATING AND CHARACTERISTICS

High Surge Varistors-20mm

Part No.	Varistor Voltage at 1mA		Maximum Allowable Voltage		Maximum Clamping Voltage		Withstanding Surge Current (8/20us)	Nominal Discharge Current (8/20us)	Rated Wattage	Energy (10/1000us)	Certification		
	DC (V)	Tolerance	AC rms (V)	DC (V)	V@ ic (V)	ic (A)					1 Time (A)	In (KA)	(W)
JVR 20S 220M	22	±20%	14	18	43	20	3000	2	0.2	16.0	★	★	★
JVR 20S 270M	27	±20%	17	22	53	20	3000	2	0.2	19.0	★	★	★
JVR 20S 330M	33	±20%	20	26	65	20	3000	2	0.2	24.0	★	★	★
JVR 20S 390L	39	±15%	25	31	77	20	3000	2	0.2	28.0	★	★	★
JVR 20S 470L	47	±15%	30	38	93	20	3000	2	0.2	34.0	★	★	★
JVR 20S 560L	56	±15%	35	45	110	20	3000	2	0.2	41.0	★	★	★
JVR 20S 680L	68	±15%	40	56	135	20	3000	2	0.2	49.0	★	★	★
JVR 20S 820L	82	±15%	50	65	135	100	10000	5	1	56.0	★	★	★
JVR 20S 101K	100	±10%	60	85	165	100	10000	5.0	1	72.0	★	★	★
JVR 20S 121K	120	±10%	75	100	200	100	10000	5.0	1	88.0	★	★	★
JVR 20S 151K	150	±10%	95	125	250	100	10000	5.0	1	106.0	★	★	★
JVR 20S 181K	180	±10%	115	150	300	100	10000	5.0	1	130.0	★	★	★
JVR 20S 201K	200	±10%	130	170	340	100	10000	5.0	1	140.0	★	★	★
JVR 20S 221K	220	±10%	140	180	360	100	10000	5.0	1	155.0	★	★	★
JVR 20S 241K	240	±10%	150	200	395	100	10000	5.0	1	168.0	★	★	★
JVR 20S 271K	270	±10%	175	225	455	100	10000	5.0	1	190.0	★	★	★
JVR 20S 301K	300	±10%	195	250	505	100	10000	5.0	1	210	★	★	★
JVR 20S 331K	330	±10%	210	275	550	100	10000	5.0	1	228.0	★	★	★
JVR 20S 361K	360	±10%	230	300	595	100	10000	5.0	1	255	★	★	★
JVR 20S 391K	390	±10%	250	320	650	100	10000	5.0	1	275	★	★	★
JVR 20S 431K	430	±10%	275	350	710	100	10000	5.0	1	303	★	★	★
JVR 20S 471K	470	±10%	300	385	775	100	10000	5.0	1	350	★	★	★
JVR 20S 511K	510	±10%	320	418	842	100	10000	5.0	1	382	★	★	★
JVR 20S 561K	560	±10%	350	460	920	100	10000	5.0	1	410	★	★	★
JVR 20S 621K	620	±10%	385	505	1025	100	10000	5.0	1	420	★	★	★
JVR 20S 681K	680	±10%	420	560	1120	100	10000	5.0	1	430	★	★	★
JVR 20S 751K	750	±10%	460	615	1240	100	10000	5.0	1	440	★	★	★
JVR 20S 781K	780	±10%	485	640	1290	100	10000	5.0	1	450	★	★	★
JVR 20S 821K	820	±10%	510	670	1355	100	10000	5.0	1	460	★	★	★
JVR 20S 911K	910	±10%	550	745	1500	100	10000	5.0	1	510	★	★	★
JVR 20S 102K	1000	±10%	625	825	1650	100	10000	5.0	1	566	★	★	★
JVR 20S 112K	1100	±10%	680	895	1815	100	10000	5.0	1	620	★	★	★
JVR 20S 122K	1200	±10%	720	975	1980	100	10000	3.0	1	680	★	★	★
JVR 20S 142K	1400	±10%	825	1135	2310	100	10000	3.0	1	790	★	★	★
JVR 20S 162K	1600	±10%	920	1300	2640	100	10000	3.0	1	905	★	★	★
JVR 20S 182K	1800	±10%	1000	1465	2970	100	10000	3.0	1	1020	★	★	★



Pulse Life time Ratings-20mm
20S 220M~20 S680L

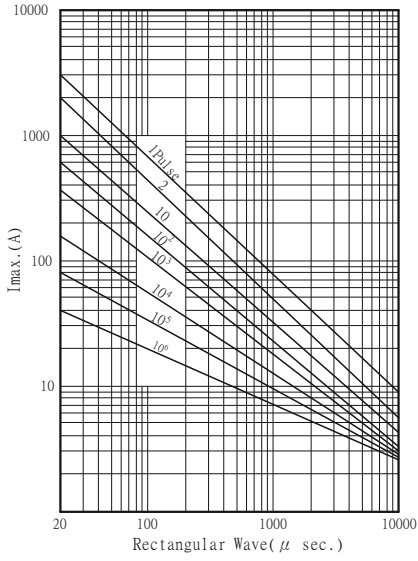

V-I Characteristic Curve-20mm
20S 220M~20 S680L

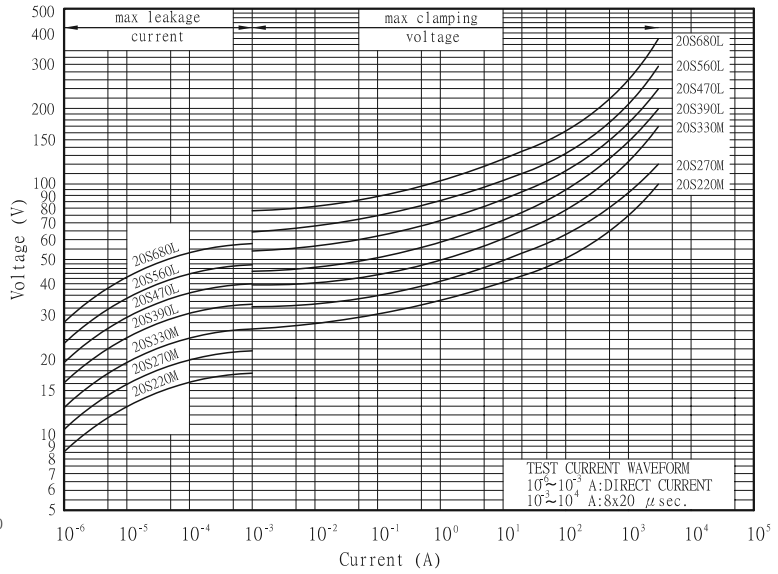

20S 101K~20S 471K

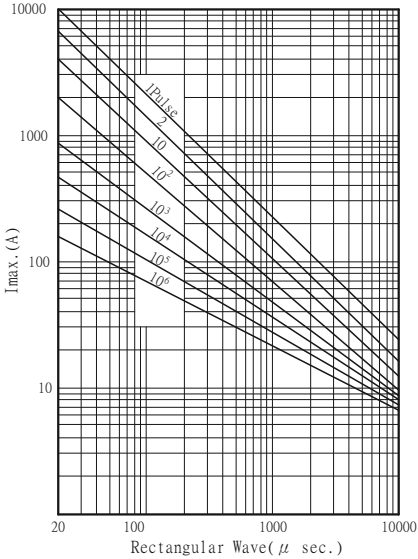

20S 101K~20S 471K

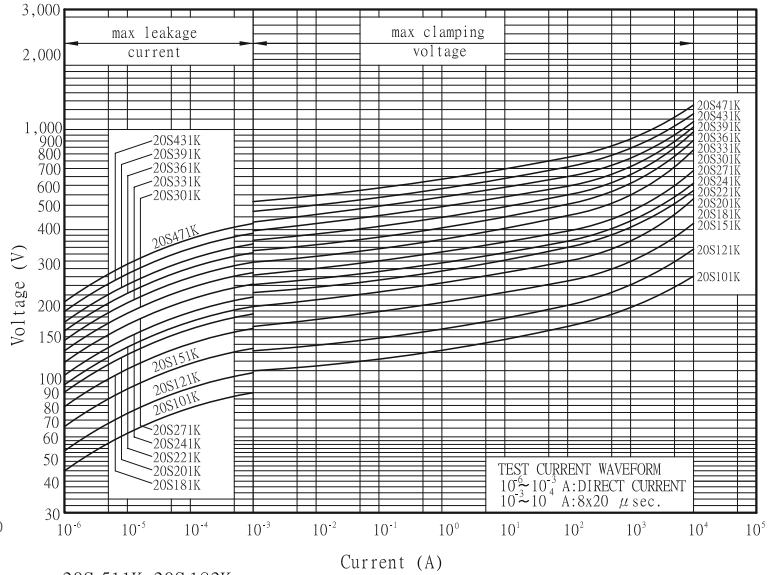

20S 511K~20S 182K

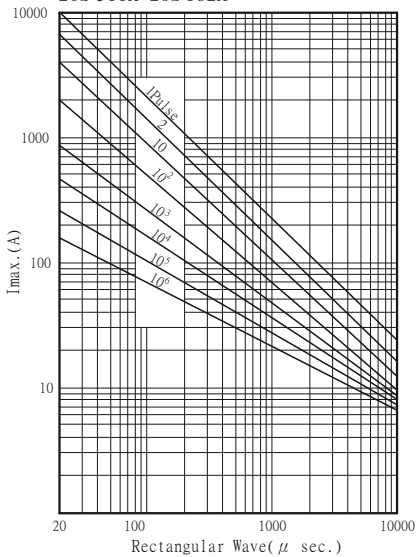

20S 511K~20S 182K

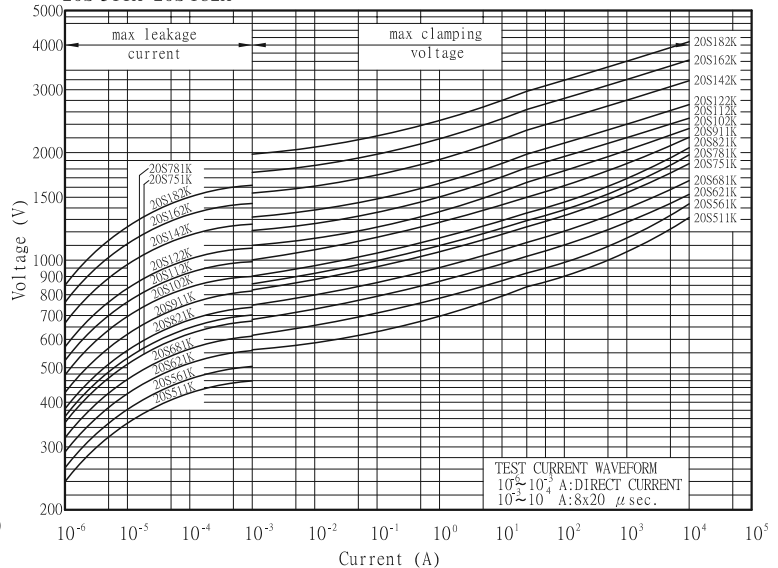

JOYIN CO., LTD

Metal Oxide Varistor

■ Reliability-JVR

Test description	Standard	Test condition	Test requirement			
Tensile Strength of Terminals	IEC60068-2-21	After gradually applying the load specified below and keeping the unit fixed for 10±1 seconds.	No visible damage $\Delta Vb\% \leq \pm 5\%$			
		<table border="1"> <thead> <tr> <th>Terminal diameter (mm)</th> <th>Force (Kg)</th> </tr> </thead> <tbody> <tr> <td>0.5 < d ≤ 0.8</td> <td>1.0</td> </tr> <tr> <td>0.8 < d ≤ 1.25</td> <td>2.0</td> </tr> </tbody> </table>		Terminal diameter (mm)	Force (Kg)	0.5 < d ≤ 0.8
Terminal diameter (mm)	Force (Kg)					
0.5 < d ≤ 0.8	1.0					
0.8 < d ≤ 1.25	2.0					
Bending Strength of Terminals	IEC60068-2-21	Hold specimen and apply the force specified below to each lead. Bend the specimen to 90°, then return to the original position. Repeat the procedure in the opposite direction.	No visible damage $\Delta Vb\% \leq \pm 5\%$			
		<table border="1"> <thead> <tr> <th>Terminal diameter (mm)</th> <th>Force (Kg)</th> </tr> </thead> <tbody> <tr> <td>0.5 < d ≤ 0.8</td> <td>0.5</td> </tr> <tr> <td>0.8 < d ≤ 1.25</td> <td>1.0</td> </tr> </tbody> </table>		Terminal diameter (mm)	Force (Kg)	0.5 < d ≤ 0.8
Terminal diameter (mm)	Force (Kg)					
0.5 < d ≤ 0.8	0.5					
0.8 < d ≤ 1.25	1.0					
Vibration	IEC60068-2-6	Frequency range : 10Hz~55Hz Amplitude : 0.75mm or 98 m/s ² Direction : 3 mutually perpendicular directions, 2hrs each.	No visible damage $\Delta Vb\% \leq \pm 5\%$			
Solderability	IEC60068-2-20	Bath temperature : 245±3°C Immersion time : 3±0.3 sec	At least 95% of terminal electrode is covered by new solder			
Resistance to soldering heat	IEC60068-2-20	Bath temperature : 260±3°C Immersion time : 10±1 sec (5N series 5±0.5s)	No visible damage $\Delta Vb(1mA) \leq \pm 5\%$			
Voltage Proof	IEC61051-1	The specified voltage is applied between both terminals of the component connected together for 1 minute .	No visible damage			
		<table border="1"> <thead> <tr> <th>2500Vrms(AC)</th> <th>Test Voltage(AC)</th> </tr> </thead> <tbody> <tr> <td></td> <td></td> </tr> </tbody> </table>		2500Vrms(AC)	Test Voltage(AC)	
2500Vrms(AC)	Test Voltage(AC)					
Rapid change of temperature	IEC60068-2-14	Temperature cycle shall be repeated 5 cycles 1. -40±3°C keeping 30±3min 2. Room temperature keeping 5±3min 3. 125±2°C keeping 30±3min 4. Room temperature keeping 5±3min	No visible damage $\Delta Vb\% \leq \pm 5\%$			
Damp heat load	IEC60068-2-78	Temperature 40±2°C R.H.90~95% and the maximum Allowable voltage for 1000±24 hours	No visible damage $\Delta Vb\% \leq \pm 10\%$			
Damp heat	IEC60068-2-78	Temperature 40±2°C R.H.90~95% for 1000±24 hours	No visible damage $\Delta Vb\% \leq \pm 5\%$			
High temperature load	MIL-STD-202 Method 108	After being continuously applied the max allowable voltage at 85±2°C for 1000±24 hours	No visible damage $\Delta Vb\% \leq \pm 10\%$			
High temperature storage	IEC60068-2-2	125±5°C for 1000±24 hours	No visible damage $\Delta Vb\% \leq \pm 5\%$			
Low temperature storage	IEC60068-2-1	-40±2°C for 1000±24 hours	No visible damage $\Delta Vb\% \leq \pm 5\%$			
Varistor Voltage Temp.Coefficient	Specification Standard	Measure V1mA at -40°C、25°C、125°C	-0.05 ≤ TC ≤ 0.05(%/°C)			
8/20μs Surge Life	IEC61051-1	8/20μs waveform, 10 surge current, unipolar, interval 30 secs, amplitude corresponding to max. surge current derating curves for 20 μs.	No visible damage $\Delta Vb\% \leq \pm 10\%$			
10/1000μs Surge Life	IEC61051-1	10/1000μs waveform, 10 surge current, unipolar, interval 2 mins, amplitude corresponding to max. surge current derating curves for 1000 μs.	No visible damage $\Delta Vb\% \leq \pm 10\%$			



Dimensions

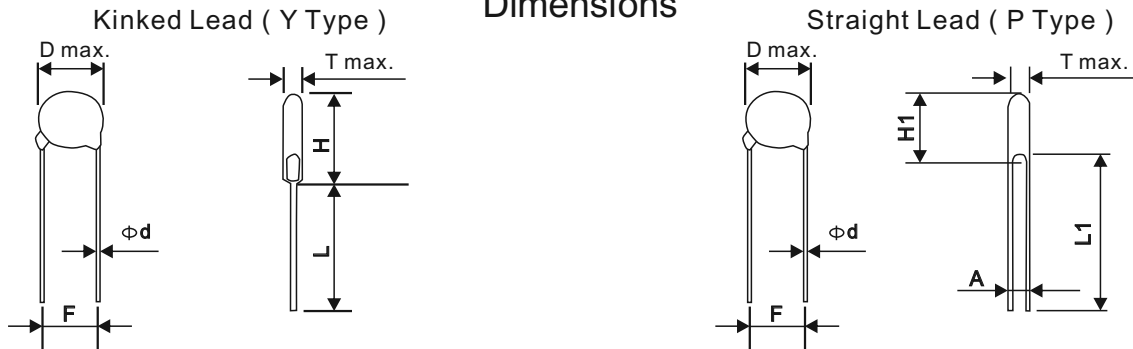

Dimensions Table

unit : mm

Diameter	5mm	7mm	10mm	14mm	20mm	25mm
D max.	7.5	9.0	12.5	16.5	23	29
d ± 0.05	0.6	0.6	0.8	0.8	1.0	1.0
F ± 1.0	5.0	5.0	7.5	7.5	10.0	10.0
H max.	11.0	12.5	17/*19	22/*23	28/*29	36
L1 min.	25.0	25.0	25.0	25.0	25.0	25.0
L min.	24.0	24.0	24.0	24.0	24.0	20.0

*Just for 182K

Table of Tmax, A&H1 max.

unit : mm

Diameter	5mm			7mm			10mm			14mm			20mm			25mm		
	T max.	A± 0.8	H1max.	T max.	A± 0.8	H1max.	T max.	A± 0.8	H1max.	T max.	A± 0.8	H1max.	T max.	A± 0.8	H1max.	T max.	A± 0.8	H1max.
180M	3.9	0.8	10.5	3.9	0.8	12.0	4.3	0.8	15.0	4.3	0.9	19.5	/	/	/	/	/	/
220M/L	4.1	0.9	10.5	4.1	0.9	12.0	4.5	0.9	15.0	4.5	1.0	19.5	4.9	1.0	26.5	/	/	/
270M/K	4.3	0.9	10.5	4.3	0.9	12.0	4.7	0.9	15.0	4.7	1.0	19.5	5.1	1.1	26.5	/	/	/
330M/K	4.5	1.0	10.5	4.5	1.0	12.0	4.9	1.0	15.0	4.9	1.2	19.5	5.3	1.2	26.5	/	/	/
390L/K	4.5	1.2	10.5	4.5	1.2	12.0	5.1	1.2	15.0	5.1	1.4	19.5	5.4	1.4	26.5	/	/	/
470L/K	4.8	1.2	10.5	4.8	1.2	12.0	5.3	1.2	15.0	5.4	1.4	19.5	5.6	1.4	26.5	/	/	/
560L/K	4.8	1.4	10.5	4.8	1.4	12.0	5.5	1.4	15.0	5.6	1.6	19.5	5.6	1.6	26.5	/	/	/
680L/K	5.1	1.7	10.5	5.1	1.7	12.0	5.7	1.6	15.0	5.6	1.9	19.5	5.9	1.9	26.5	/	/	/
820K	3.8	0.8	10.5	3.8	0.8	12.0	4.3	0.8	15.0	4.3	1.0	19.5	4.7	1.1	26.5	/	/	/
101K	3.9	0.8	10.5	3.9	0.8	12.0	4.4	0.8	15.0	4.5	1.0	19.5	4.9	1.2	26.5	/	/	/
121K	4.1	0.9	10.5	4.1	0.9	12.0	4.5	0.9	15.0	4.6	1.1	19.5	5.1	1.3	26.5	/	/	/
151K	4.5	1.2	10.5	4.5	1.2	12.0	4.9	1.2	15.0	5.0	1.4	19.5	5.4	1.6	26.5	/	/	/
181K	3.9	1.0	10.5	3.9	1.0	12.0	4.3	1.0	15.0	4.3	1.2	19.5	5.0	1.4	26.5	/	/	/
201K	4.0	1.0	10.5	4.0	1.0	12.0	4.4	1.0	15.0	4.4	1.2	19.5	5.1	1.4	26.5	5.4	2.5	35
221K	4.0	1.1	10.5	4.0	1.1	12.0	4.4	1.1	15.0	4.4	1.3	19.5	5.2	1.5	26.5	5.6	2.6	35
241K	4.2	1.1	10.5	4.2	1.3	12.0	4.6	1.3	15.0	4.6	1.5	19.5	5.3	1.7	26.5	5.7	2.8	35
271K	4.4	1.3	10.5	4.4	1.4	12.0	4.8	1.4	15.0	4.8	1.5	19.5	5.5	1.9	26.5	6.0	3.0	35
301K	4.4	1.3	10.5	4.4	1.5	12.0	4.8	1.6	15.0	4.8	1.7	19.5	5.7	2.1	26.5	6.3	3.2	35
331K	4.5	1.3	10.5	4.5	1.5	12.0	4.9	1.6	15.0	4.9	1.7	19.5	5.8	2.1	26.5	6.6	3.4	35
361K	4.7	1.8	10.5	4.6	1.9	12.0	5.0	1.9	15.0	5.0	2.1	19.5	6.0	2.3	26.5	6.8	3.6	35
391K	4.8	2.0	11.0	4.8	2.0	12.5	5.2	2.2	15.0	5.2	2.2	19.5	6.2	2.4	26.5	7.1	3.9	35
431K	5.1	2.1	11.0	5.1	2.0	12.5	5.5	2.5	15.0	5.5	2.5	19.5	6.6	2.7	26.5	7.2	3.3	35
471K	5.2	2.2	11.0	5.2	2.3	12.5	5.6	2.6	15.0	5.6	2.7	19.5	6.8	2.9	27.0	7.4	3.5	35
511K	5.6	2.5	11.5	5.6	2.5	12.5	5.8	3.1	15.0	5.8	3.1	20.0	7.0	3.3	27.0	7.6	3.8	35
561K	5.7	2.8	11.5	5.7	2.8	12.5	6.1	3.4	15.0	6.1	3.4	20.0	7.3	3.6	27.0	7.9	4.0	35
621K	6.0	3.1	11.5	6.0	3.1	12.5	6.4	4.0	15.0	6.4	3.8	20.0	7.6	4.1	27.0	8.2	4.4	35
681K	6.3	3.4	11.5	6.3	3.4	12.5	6.8	4.4	15.0	6.8	4.1	20.0	8.0	4.4	27.0	8.3	4.7	35
751K	6.7	3.7	11.5	6.8	3.7	12.5	7.2	4.4	15.0	7.2	4.3	20.0	8.4	4.5	27.0	8.7	5.0	35
781K	/	/	/	7.0	3.9	12.5	7.3	4.6	15.0	7.3	4.6	20.0	8.6	4.8	27.0	8.9	5.2	35
821K	/	/	/	7.2	4.1	12.5	7.6	4.6	15.0	7.6	4.6	20.0	8.8	4.8	27.0	9.1	5.4	35
911K	/	/	/	/	/	/	8.2	5.4	16.0	8.2	5.4	20.5	9.3	5.7	27.0	9.6	5.9	35
102K	/	/	/	/	/	/	8.5	5.4	16.0	8.6	5.6	20.5	9.9	5.8	27.0	/	/	/
112K	/	/	/	/	/	/	9.1	5.7	16.0	9.1	6.1	20.5	10.3	6.3	27.0	/	/	/
122K	/	/	/	/	/	/	9.9	6.3	17.0	10.0	6.7	21.0	11.3	6.9	27.5	/	/	/
142K	/	/	/	/	/	/	10.7	7.4	17.5	10.9	7.8	21.5	12.8	8.0	28.0	/	/	/
162K	/	/	/	/	/	/	11.5	8.6	17.5	11.8	9.0	21.5	13.0	9.2	28.5	/	/	/
182K	/	/	/	/	/	/	12.6	9.8	17.5	12.8	10.2	21.5	13.5	10.4	29.0	/	/	/

過電壓保護

Tape and Reel Dimensions

1/2" pitch

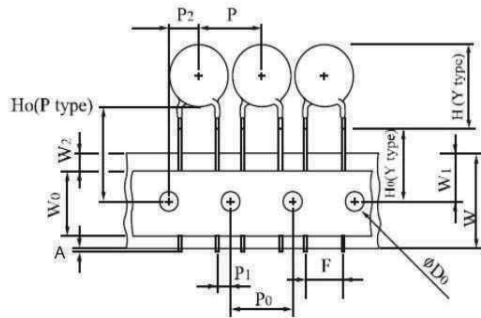

1.0" pitch

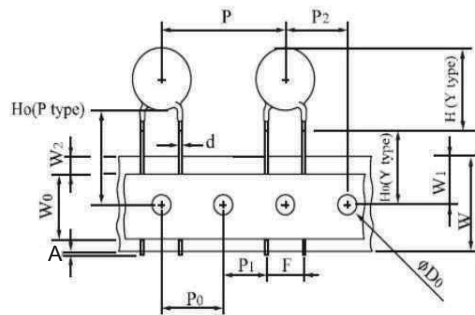

Symbols	Item	5 / 7 mm	10 / 14 mm	20 mm
A	Cut out length	1.1 mm max.	1.1 mm max.	
H (Y type)	Height of Top	See H max. table		
H0(Y type)	Height to seating plane	16.0 ± 0.5 mm (* ± 1.0 mm)	16.0 ± 0.5 mm (* ± 1.0 mm)	
H0(P type)	Height of component from hole center	16.0 ~ 21.0 mm	16.0 ~ 21.0 mm	
Δh	Front to back deviation	0 ± 2.0 mm	0 ± 2.0 mm	
W	Carrier tape width	18 ^{+1.0} _{-0.5} mm	18 ^{+1.0} _{-0.5} mm	
W0	Hold down tape width	10.0 mm	12.0 mm	
W1	Sprocket hole position	9.0 ^{+0.75} _{-0.5} mm	9.0 ^{+0.75} _{-0.5} mm	
W2	Adhesive tape position	3.0 mm max.	3.0 mm max.	
F	Component lead spacing	5.0 ± 1.0 mm	7.5 ± 1.0 mm	10.0 ± 1.0 mm
P	Pitch of component	12.7 ± 1.0 mm	25.4 ± 1.0 mm	
P0	Sprocket hole pitch	12.7 ± 0.3 mm	12.7 ± 0.3 mm	
P1	Lead length from hole center to lead	3.85 ± 0.7 mm	8.95 ± 0.7 mm	7.7 ± 0.7 mm
P2	Length from hole center to disk center	6.35 ± 1.3 mm	12.7 ± 1.3 mm	
D0	Sprocket hole diameter	4.0 ± 0.2 mm	4.0 ± 0.2 mm	
d	Lead wire diameter	0.6 ± 0.05 mm	0.8 ± 0.05 mm	1.0 ± 0.05 mm
T	Disk thickness	See Tmax. table	See T max. table	
t1	Total thickness tape	0.7 ± 0.05 mm	0.7 ± 0.05 mm	
t2	Total thickness	1.6 mm max.	1.8 mm max.	



Marking & packaging

MARKING

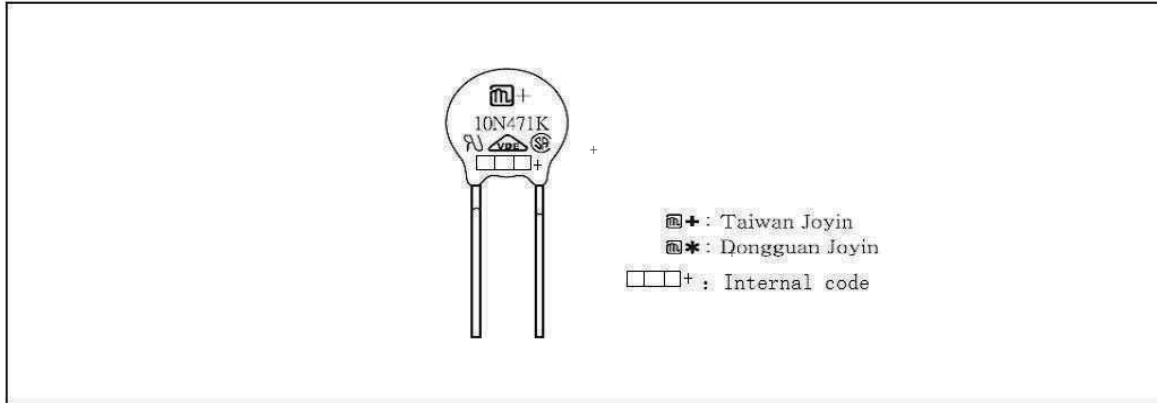

PACKAGING

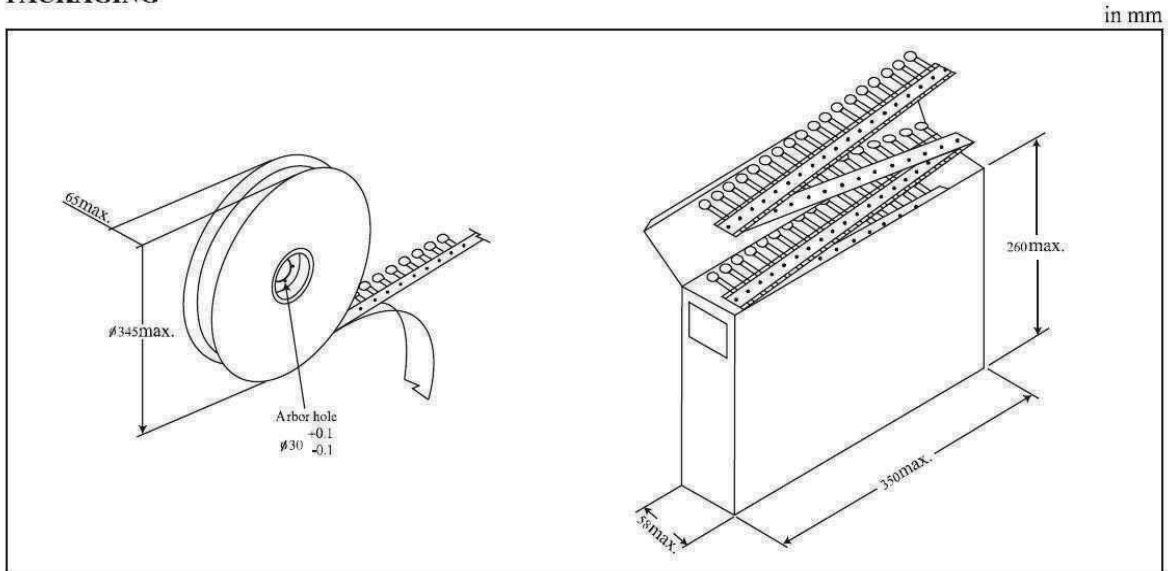

Quantity per Packing Unit

in Pcs

Series Part No.	5 mm			7 mm			10 mm			14 mm			20 mm			25 mm
	Bulk (Box)	Reel	Ammo	Bulk (Box)	Reel	Ammo	Bulk (Box)	Reel	Ammo	Bulk (Box)	Reel	Ammo	Bulk (Box)	Reel	Ammo	Bulk (Box)
180M~470K	5000	1500	1500	5000	1500	1500	2500	1000	500	1500	750	500	750	500	500	-
560K~680K	5000	1500	1000	5000	1500	1000	2500	1000	500	1500	750	500	750	500	500	-
820K~391K	5000	1500	1500	5000	1500	1500	2500	1000	500	1500	750	500	750	500	500	750
431K~471K	5000	1500	1000	5000	1000	1000	2000	750	500	1500	750	500	750	500	500	750
511K~821K	4000	1000	1000	4000	1000	1000	1500	500	500	750	500	500	450	500	500	450
911K~122K	-	-	-	-	-	-	1500	500	350	750	500	350	450	-	-	450
142K~182K	-	-	-	-	-	-	750	-	-	450	-	-	300	-	-	-

Packaging	Bulk (Box)	Reel	Reel (14 mm, 20mm)	Ammo (5 mm, 7mm)	Ammo (10 mm, 14 mm)	Ammo (20 mm)
Box size (mm)	290×155×110	350×350×105	346×346×72	335×245×43	347×246×50	348×255×60
Carton size (mm)	328×310×250	370×370×590	370×370×468	515×354×258	515×364×246	535×365×275
One carton with	4 Boxes	5 Boxes (10 reels)	6 Boxes (6 reels)	10 Boxes	8 Boxes	8 Boxes

X-ON Electronics

Largest Supplier of Electrical and Electronic Components

Click to view similar products for [Varistors](#) category:

Click to view products by [Joyin](#) manufacturer:

Other Similar products are found below :

[R71ZOV151HC](#) [B72205S271K111](#) [B72214S110K151](#) [B72214S251K151](#) [B72540E250K62](#) [NTE1V020](#) [NTE1V130](#) [NTE2V010](#) [NTE2V130](#)
[25FN511K](#) [S10K11G5S5](#) [ERZ-C14DK361U](#) [ERZ-C20DK221U](#) [ERZ-C32CK201B](#) [207869-1](#) [AS-13](#) [B72210S251K531](#) [B72214S200K551](#)
[B72280B112K1](#) [B72590D360A60](#) [B72650M301K93](#) [B72670M1140K72](#) [TVZ18EC271KBS](#) [TVZ20EB911KBS](#) [TVZ25D201KBS](#)
[TVZ25D241KBS](#) [VDRH20X230BSE](#) [VZ07D220KBS](#) [VZ40D241K](#) [VZ25D511KBS-N](#) [VZ20E511KBSX](#) [VZ20E221KBSX](#)
[VZ10D471KBS-N](#) [ERZ-V20R221](#) [B72205S350K211](#) [B72214S110K551](#) [B72510E140K62](#) [B72650M151K93](#) [B72650M350K72](#)
[TVZ25DN271KBS](#) [TVZ25D301KBS](#) [TVZ20EC911KBS](#) [TVZ20EBN911KBS](#) [TVZ18EC471KBS](#) [B72207S110K211](#) [B72220S350K101](#)
[B72540E300K62](#) [TND10V-271KB00AAA0](#) [NTE1V030](#) [NTE1V275](#)