

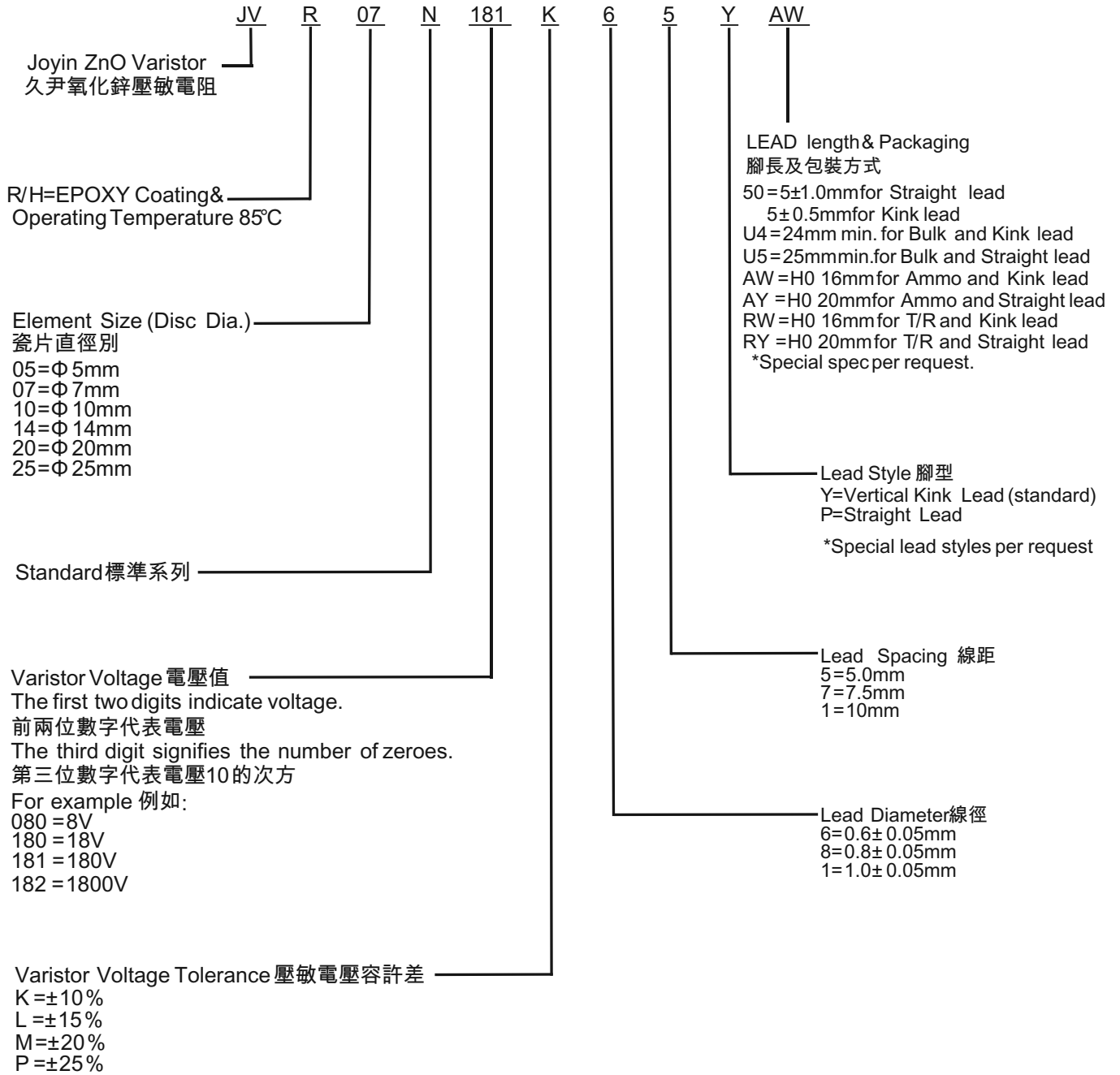

ORDERING CODE



過電壓保護



RATING AND CHARACTERISTICS

Standard Varistors - 5mm

Part No.	Varistor Voltage at 0.1mA		Maximum Allowable Voltage		Maximum Clamping Voltage		Withstanding Surge Current (8/20us)	Nominal Discharge Current (8/20us)	Rated Wattage	Energy (10/1000us)	Certification		
	DC (V)	Tolerance	AC rms (V)	DC (V)	V@ ic (V)	ic (A)	1 Time (A)	In (KA)	(W)	(J)	UL	VDE	CQC
JVR 05N 180M	18	±20%	11	14	40	1	100	0.1	0.01	0.6	☆	☆	☆
JVR 05N 220L	22	±15%	14	18	48	1	100	0.1	0.01	0.7	☆	☆	☆
JVR 05N 270K	27	±10%	17	22	60	1	100	0.1	0.01	0.9	☆	☆	☆
JVR 05N 330K	33	±10%	20	26	73	1	100	0.1	0.01	1.1	☆	☆	☆
JVR 05N 390K	39	±10%	25	31	86	1	100	0.1	0.01	1.2	☆	☆	☆
JVR 05N 470K	47	±10%	30	38	104	1	100	0.1	0.01	1.5	☆	☆	☆
JVR 05N 560K	56	±10%	35	45	123	1	100	0.1	0.01	1.8	☆	☆	☆
JVR 05N 680K	68	±10%	40	56	150	1	100	0.1	0.01	2.1	☆	☆	☆
JVR 05N 820K	82	±10%	50	65	145	5	400	0.1	0.1	2.8	☆	☆	☆
JVR 05N 101K	100	±10%	60	85	175	5	400	0.1	0.1	3.5	☆	☆	☆
JVR 05N 121K	120	±10%	75	100	210	5	400	0.1	0.1	4	☆	☆	☆
JVR 05N 151K	150	±10%	95	125	260	5	400	0.1	0.1	5.5	☆	☆	☆
JVR 05N 181K	180	±10%	115	150	320	5	400	0.1	0.1	6.5	☆	☆	☆
JVR 05N 201K	200	±10%	130	170	355	5	400	0.1	0.1	7.1	☆	☆	☆
JVR 05N 221K	220	±10%	140	180	380	5	400	0.1	0.1	7.8	☆	☆	☆
JVR 05N 241K	240	±10%	150	200	415	5	400	0.1	0.1	8.4	☆	☆	☆
JVR 05N 271K	270	±10%	175	225	475	5	400	0.1	0.1	9.9	☆	☆	☆
JVR 05N 301K	300	±10%	195	250	525	5	400	0.1	0.1	10.5	☆	☆	☆
JVR 05N 331K	330	±10%	210	275	575	5	400	0.1	0.1	11.5	☆	☆	☆
JVR 05N 361K	360	±10%	230	300	620	5	400	0.1	0.1	13	☆	☆	☆
JVR 05N 391K	390	±10%	250	320	675	5	400	0.1	0.1	15	☆	☆	☆
JVR 05N 431K	430	±10%	275	350	745	5	400	0.1	0.1	16.5	☆	☆	☆
JVR 05N 471K	470	±10%	300	385	810	5	400	0.1	0.1	17.5	☆	☆	☆
JVR 05N 511K	510	±10%	320	418	880	5	400	0.1	0.1	18.5	☆	☆	☆
JVR 05N 561K	560	±10%	350	460	940	5	400	0.1	0.1	19.5	☆	☆	☆
JVR 05N 621K	620	±10%	385	505	1050	5	400	0.1	0.1	20.5	☆	☆	☆
JVR 05N 681K	680	±10%	420	560	1150	5	400	0.1	0.1	21.5	☆	☆	☆
JVR 05N 751K	750	±10%	460	615	1290	5	400	0.1	0.1	22.5	☆	☆	☆

過電壓保護

Application notes for UL,CSA,VDE and CQC reconized related standards

Standard NO.	UL	CUL	VDE		CQC	
	UL 1449 4 TH Edition	CSA 22.2 No. 269.5	IEC61051-1 IEC61051-2 IEC61051-2-2	IEC61051-1 IEC61051-2 IEC61051-2-2 IEC60950-1:2013AnnexQ IEC62368-1:2014 / G.8.2	GB/T1093-1997 GB/T10194-1997	GB4943.1-2011 GB/T1093-1997 GB/T10194-1997 GB8898 -2011
Title	Transient Voltage Surge Suppressors	Transient Voltage Surge Suppressors	Varistors for use in electronic equipment		Engaged in Voluntary Product Certification	
Certificate No.	VZCA2.E325508	VZCA8.E325508	5937		CQC07001019159/9161/9162/9163/9164	
Symbols	☆		☆	★	☆	⊕



Pulse Life time Ratings-5mm
05N 180M-05N 680K

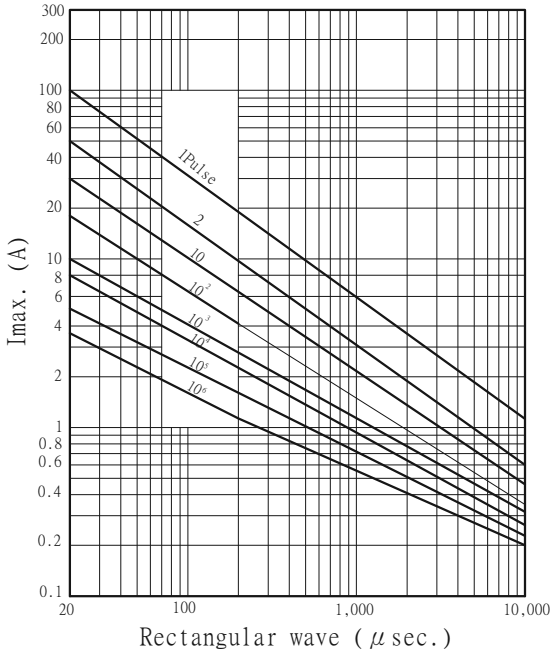

V-I Characteristic Curve-5mm
05N 180M-05N 680K

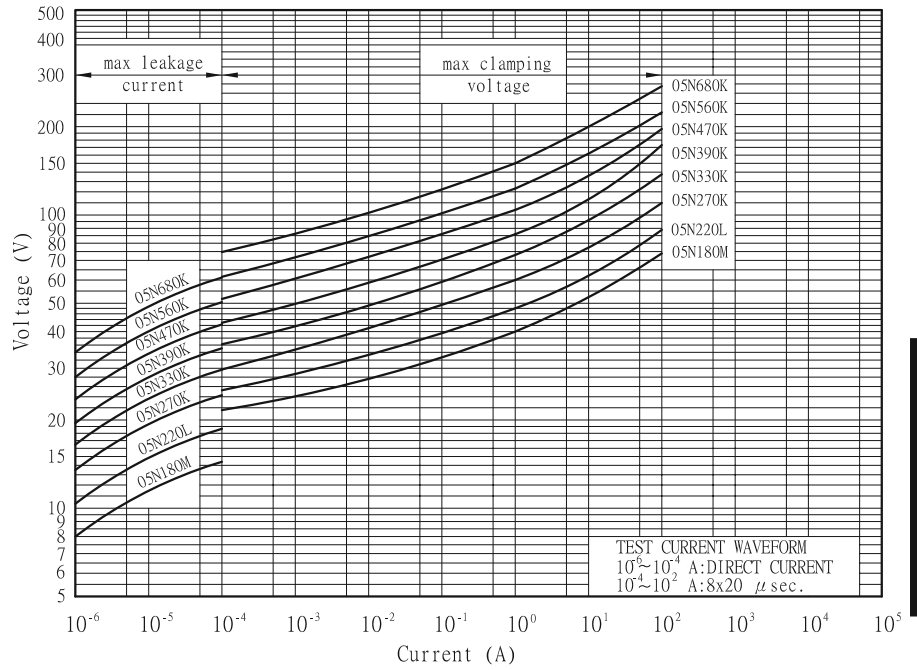

過電壓保護

05N 820K-05N 751K

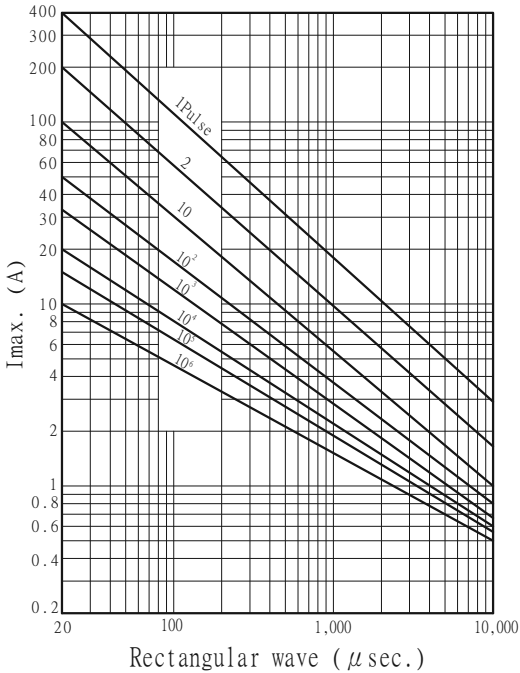

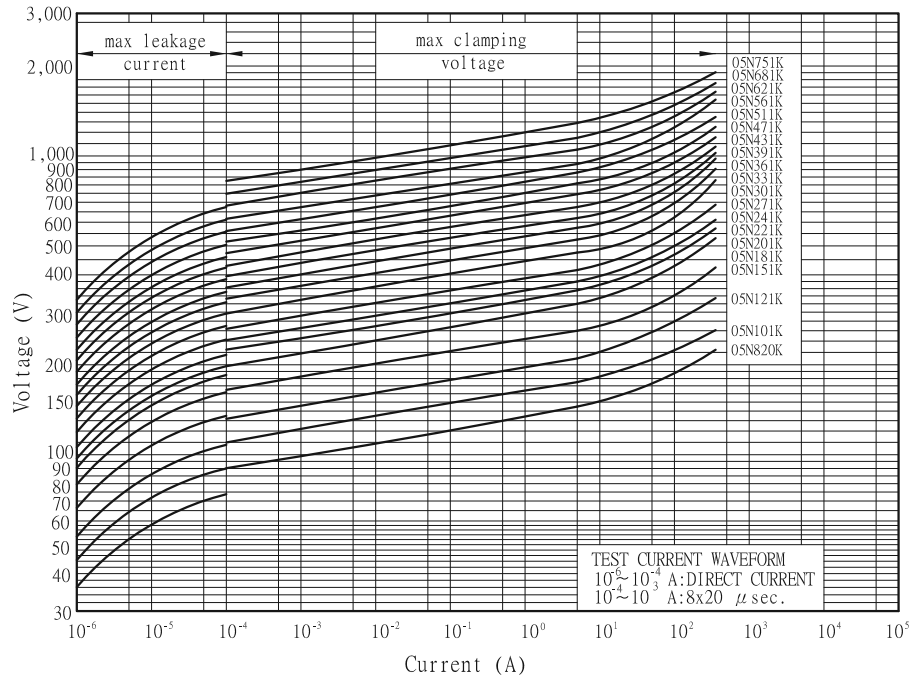

05N 820K-05N 751K





RATING AND CHARACTERISTICS

Standard Varistors - 7mm

Part No.	Varistor Voltage at 1mA		Maximum Allowable Voltage		Maximum Clamping Voltage		Withstanding Surge Current (8/20us)	Nominal Discharge Current (8/20us)	Rated Wattage	Energy (10/1000us)	Certification
	DC (V)	Tolerance	AC rms (V)	DC (V)	V@ ic (V)	ic (A)	1 Time (A)	In (KA)	(W)	(J)	  
JVR 07N 180M	18	±20%	11	14	40	2.5	250	0.2	0.02	1.2	☆ ☆ ☆
JVR 07N 220L	22	±15%	14	18	48	2.5	250	0.2	0.02	1.4	☆ ☆ ☆
JVR 07N 270K	27	±10%	17	22	60	2.5	250	0.2	0.02	1.7	☆ ☆ ☆
JVR 07N 330K	33	±10%	20	26	73	2.5	250	0.2	0.02	2.2	☆ ☆ ☆
JVR 07N 390K	39	±10%	25	31	86	2.5	250	0.2	0.02	2.4	☆ ☆ ☆
JVR 07N 470K	47	±10%	30	38	104	2.5	250	0.2	0.02	3.0	☆ ☆ ☆
JVR 07N 560K	56	±10%	35	45	123	2.5	250	0.2	0.02	3.5	☆ ☆ ☆
JVR 07N 680K	68	±10%	40	56	150	2.5	250	0.2	0.02	4.3	☆ ☆ ☆
JVR 07N 820K	82	±10%	50	65	145	10	1200	0.5	0.25	5.5	☆ ☆ ☆
JVR 07N 101K	100	±10%	60	85	175	10	1200	0.5	0.25	7.0	☆ ☆ ☆
JVR 07N 121K	120	±10%	75	100	210	10	1200	0.5	0.25	8.0	☆ ☆ ☆
JVR 07N 151K	150	±10%	95	125	260	10	1200	0.5	0.25	11.0	☆ ☆ ☆
JVR 07N 181K	180	±10%	115	150	320	10	1200	0.5	0.25	13.0	☆ ☆ ☆
JVR 07N 201K	200	±10%	130	170	355	10	1200	0.5	0.25	14.3	☆ ☆ ☆
JVR 07N 221K	220	±10%	140	180	380	10	1200	0.5	0.25	15.5	☆ ☆ ☆
JVR 07N 241K	240	±10%	150	200	415	10	1200	0.5	0.25	16.8	☆ ☆ ☆
JVR 07N 271K	270	±10%	175	225	475	10	1200	0.5	0.25	19.8	☆ ☆ ☆
JVR 07N 301K	300	±10%	195	250	525	10	1200	0.5	0.25	21.0	☆ ☆ ☆
JVR 07N 331K	330	±10%	210	275	575	10	1200	0.5	0.25	23.0	☆ ☆ ☆
JVR 07N 361K	360	±10%	230	300	620	10	1200	0.5	0.25	26.0	☆ ☆ ☆
JVR 07N 391K	390	±10%	250	320	675	10	1200	0.5	0.25	30.0	☆ ☆ ☆
JVR 07N 431K	430	±10%	275	350	745	10	1200	0.5	0.25	33.0	☆ ☆ ☆
JVR 07N 471K	470	±10%	300	385	810	10	1200	0.5	0.25	35.0	☆ ☆ ☆
JVR 07N 511K	510	±10%	320	418	880	10	1200	0.5	0.25	37.0	☆ ☆ ☆
JVR 07N 561K	560	±10%	350	460	940	10	1200	0.5	0.25	39.0	☆ ☆ ☆
JVR 07N 621K	620	±10%	385	505	1050	10	1200	0.5	0.25	41.0	☆ ☆ ☆
JVR 07N 681K	680	±10%	420	560	1150	10	1200	0.5	0.25	43.0	☆ ☆ ☆
JVR 07N 751K	750	±10%	460	615	1290	10	1200	0.5	0.25	45.0	☆ ☆ ☆
JVR 07N 781k	780	±10%	485	640	1290	10	1200	0.5	0.25	46.0	☆ ☆ ☆
JVR 07N 821k	820	±10%	510	670	1355	10	1200	0.5	0.25	47.0	☆ ☆ ☆

過電壓保護



過電壓保護

Pulse Life time Ratings-7mm
07N 820K-07N 821K

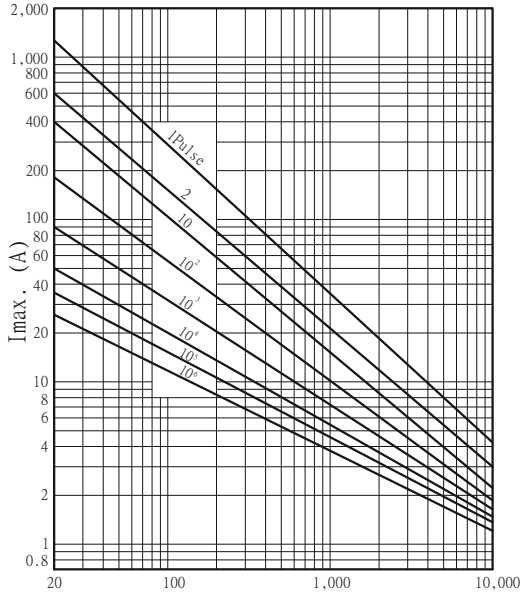

V-I Characteristic Curve-7mm
07N 820K-07N 821K

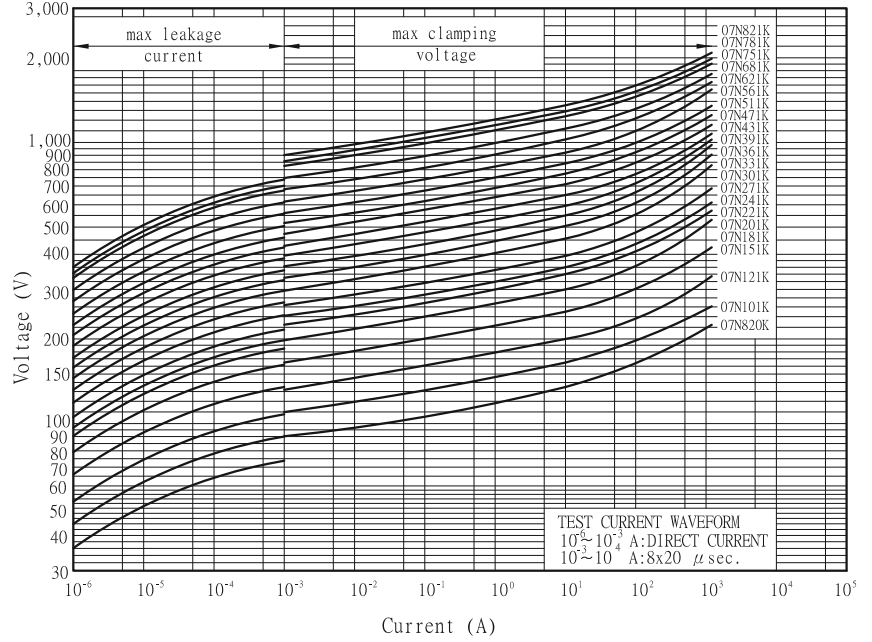

07N 180M-07N 680K

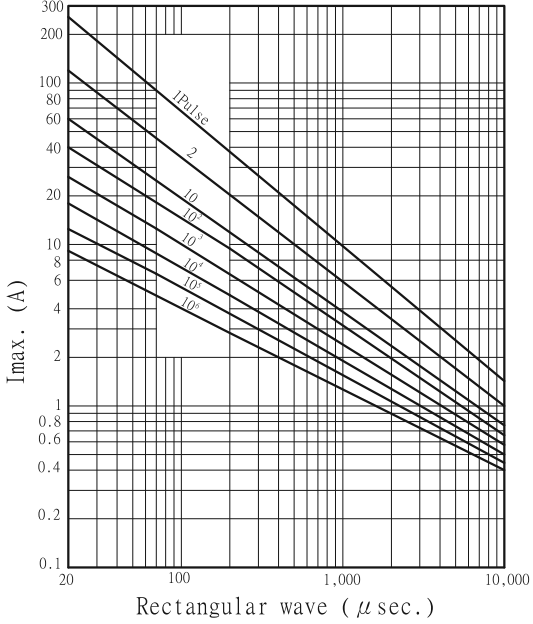

07N 180M-07N 680K

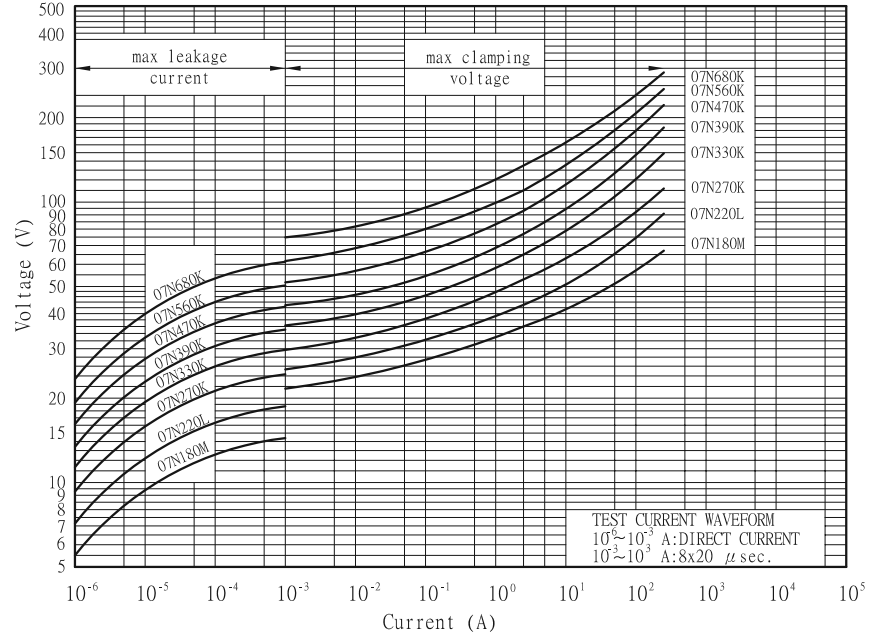



RATING AND CHARACTERISTICS
Standard Varistors- 10mm

Part No.	Varistor Voltage at 1mA		Maximum Allowable Voltage		Maximum Clamping Voltage		Withstanding Surge Current (8/20us)	Nominal Discharge Current (8/20us)	Rated Wattage	Energy (10/1000us)	Certification		
	DC (V)	Tolerance	AC rms (V)	DC (V)	V@ ic (V)	ic (A)	1 Time (A)	In (KA)	(W)	(J)	UL	IEC	CEC
JVR 10N 180M	18	±20%	11	14	36	5	500	0.3	0.05	2.4	☆	☆	☆
JVR 10N 220L	22	±15%	14	18	43	5	500	0.3	0.05	2.7	☆	☆	☆
JVR 10N 270K	27	±10%	17	22	53	5	500	0.3	0.05	3.5	☆	☆	☆
JVR 10N 330K	33	±10%	20	26	65	5	500	0.3	0.05	4.4	☆	☆	☆
JVR 10N 390K	39	±10%	25	31	77	5	500	0.3	0.05	4.7	☆	☆	☆
JVR 10N 470K	47	±10%	30	38	93	5	500	0.3	0.05	6.0	☆	☆	☆
JVR 10N 560K	56	±10%	35	45	110	5	500	0.3	0.05	7.0	☆	☆	☆
JVR 10N 680K	68	±10%	40	56	135	5	500	0.3	0.05	8.5	☆	☆	☆
JVR 10N 820K	82	±10%	50	65	135	25	2500	1.5	0.4	11.0	☆	☆	☆
JVR 10N 101K	100	±10%	60	85	165	25	2500	1.5	0.4	14.0	☆	☆	☆
JVR 10N 121K	120	±10%	75	100	200	25	2500	1.5	0.4	16.0	☆	☆	☆
JVR 10N 151K	150	±10%	95	125	250	25	2500	1.5	0.4	22.0	☆	☆	☆
JVR 10N 181K	180	±10%	115	150	300	25	2500	1.5	0.4	26.0	☆	☆	☆
JVR 10N 201K	200	±10%	130	170	340	25	2500	1.5	0.4	28.5	☆	☆	☆
JVR 10N 221K	220	±10%	140	180	360	25	2500	1.5	0.4	31.0	☆	☆	☆
JVR 10N 241K	240	±10%	150	200	395	25	2500	1.5	0.4	33.5	☆	☆	☆
JVR 10N 271K	270	±10%	175	225	455	25	2500	1.5	0.4	39.5	☆	☆	☆
JVR 10N 301K	300	±10%	195	250	505	25	2500	1.5	0.4	42.0	☆	☆	☆
JVR 10N 331K	330	±10%	210	275	550	25	2500	1.5	0.4	46.0	☆	☆	☆
JVR 10N 361K	360	±10%	230	300	595	25	2500	1.5	0.4	52.0	☆	☆	☆
JVR 10N 391K	390	±10%	250	320	650	25	2500	1.5	0.4	60.0	☆	☆	☆
JVR 10N 431K	430	±10%	275	350	710	25	2500	1.5	0.4	66.0	☆	☆	☆
JVR 10N 471K	470	±10%	300	385	775	25	2500	1.5	0.4	70.0	☆	☆	☆
JVR 10N 511K	510	±10%	320	418	842	25	2500	1.5	0.4	74.0	☆	☆	☆
JVR 10N 561K	560	±10%	350	460	920	25	2500	1.5	0.4	78.0	☆	☆	☆
JVR 10N 621K	620	±10%	385	505	1025	25	2500	1.5	0.4	82.0	☆	☆	☆
JVR 10N 681K	680	±10%	420	560	1120	25	2500	1.5	0.4	86.0	☆	☆	☆
JVR 10N 751K	750	±10%	460	615	1240	25	2500	1.5	0.4	90.0	☆	☆	☆
JVR 10N 781K	780	±10%	485	640	1290	25	2500	1.5	0.4	92.0	☆	☆	☆
JVR 10N 821K	820	±10%	510	670	1355	25	2500	1.5	0.4	94.0	☆	☆	☆
JVR 10N 911K	910	±10%	550	745	1500	25	2500	1.5	0.4	102.0	☆	☆	☆
JVR 10N 102K	1000	±10%	625	825	1650	25	2500	1.5	0.4	112.0	☆	☆	☆
JVR 10N 112K	1100	±10%	680	895	1815	25	2500	1.5	0.4	124.0	☆	☆	☆
JVR 10N 122K	1200	±10%	720	975	1980	25	2500	1.5	0.4	134.0	☆	☆	☆
JVR 10N 142K	1400	±10%	825	1135	2310	25	2500	1.5	0.4	148.0	☆	☆	☆
JVR 10N 162K	1600	±10%	920	1300	2640	25	2500	1.5	0.4	162.0	☆	☆	☆
JVR 10N 182K	1800	±10%	1000	1465	2970	25	2500	1.5	0.4	174.0	☆	☆	☆

過電壓保護



Pulse Life time Ratings-10mm
10N 180M~10N 680K

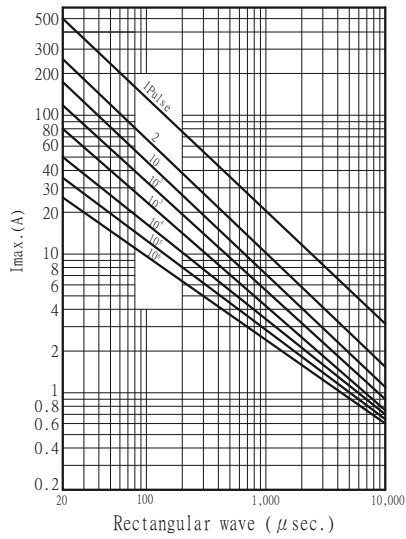

V-I Characteristic Curve-10mm
10N 180M~10N 680K

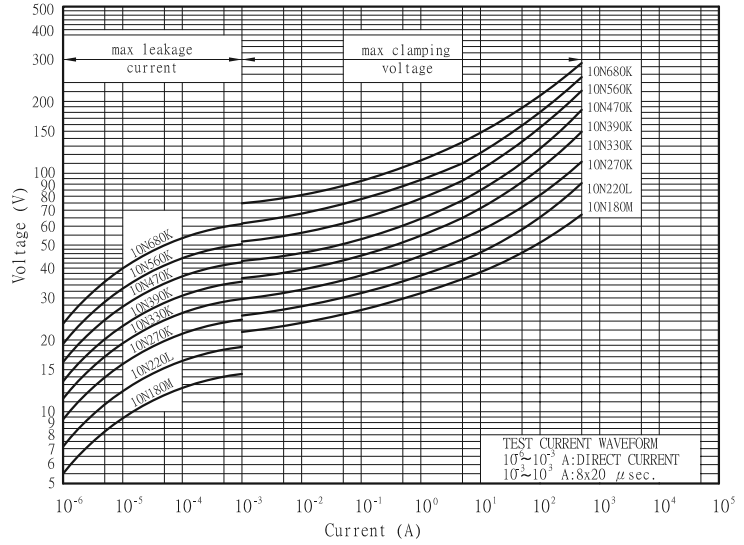

10N 820K~10N 471K

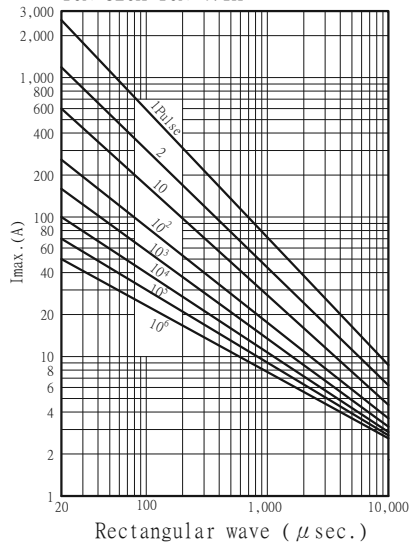

10N 820K~10N 471K

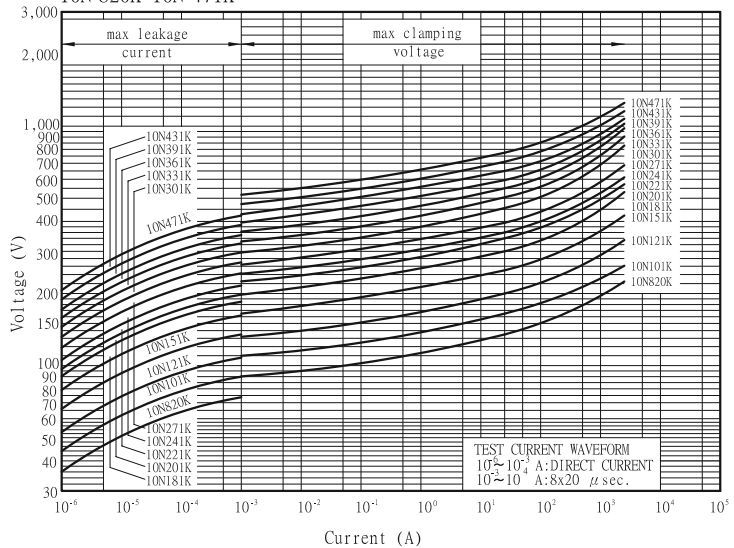

10N 511K~10N 182K

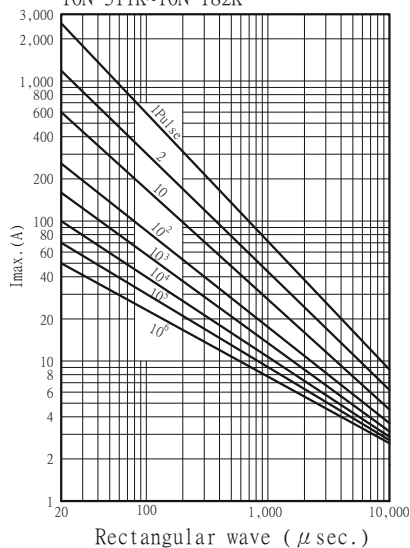

10N 511K~10N 182K

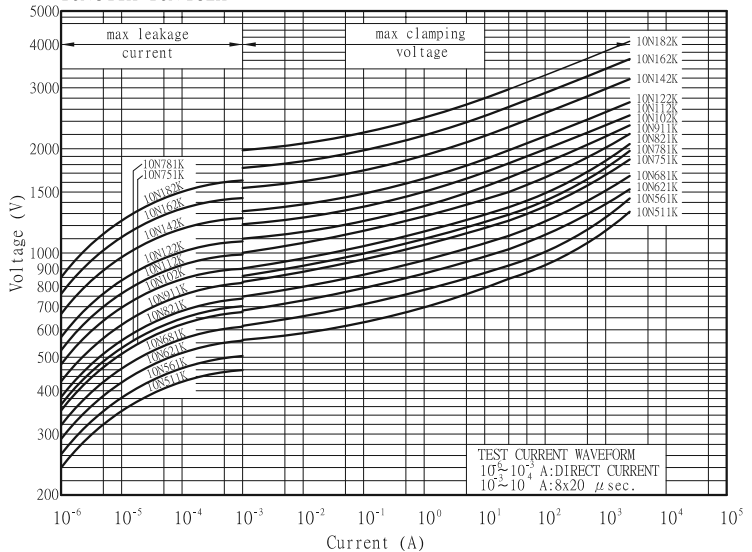

過電壓保護



RATING AND CHARACTERISTICS

Standard Varistors - 14mm

Part No.	Varistor Voltage at 1mA		Maximum Allowable Voltage		Maximum Clamping Voltage		Withstanding Surge Current (8/20us)	Nominal Discharge Current (8/20us)	Rated Wattage	Energy (10/1000us)	Certification		
	DC (V)	Tolerance	AC rms (V)	DC (V)	V@ic (V)	ic (A)	1 Time (A)	In (KA)	(W)	(J)	UL	UL	CEC
JVR 14N 180M	18	±20%	11	14	36	10	1000	1	0.1	4.7	☆	☆	☆
JVR 14N 220L	22	±15%	14	18	43	10	1000	1	0.1	5.4	☆	☆	☆
JVR 14N 270K	27	±10%	17	22	53	10	1000	1	0.1	6.9	☆	☆	☆
JVR 14N 330K	33	±10%	20	26	65	10	1000	1	0.1	8.8	☆	☆	☆
JVR 14N 390K	39	±10%	25	31	77	10	1000	1	0.1	9.4	☆	☆	☆
JVR 14N 470K	47	±10%	30	38	93	10	1000	1	0.1	12.0	☆	☆	☆
JVR 14N 560K	56	±10%	35	45	110	10	1000	1	0.1	14.0	☆	☆	☆
JVR 14N 680K	68	±10%	40	56	135	10	1000	1	0.1	17.0	☆	☆	☆
JVR 14N 820K	82	±10%	50	65	135	50	4500	3.0	0.6	22.0	☆	☆	☆
JVR 14N 101K	100	±10%	60	85	165	50	4500	3.0	0.6	28.0	☆	☆	☆
JVR 14N 121K	120	±10%	75	100	200	50	4500	3.0	0.6	32.0	☆	☆	☆
JVR 14N 151K	150	±10%	95	125	250	50	4500	3.0	0.6	44.0	☆	☆	☆
JVR 14N 181K	180	±10%	115	150	300	50	4500	3.0	0.6	52.0	☆	★	☆
JVR 14N 201K	200	±10%	130	170	340	50	4500	3.0	0.6	57.0	☆	★	☆
JVR 14N 221K	220	±10%	140	180	360	50	4500	3.0	0.6	62.0	☆	★	☆
JVR 14N 241K	240	±10%	150	200	395	50	4500	3.0	0.6	67.0	☆	★	☆
JVR 14N 271K	270	±10%	175	225	455	50	4500	3.0	0.6	79	☆	★	☆
JVR 14N 301K	300	±10%	195	250	505	50	4500	3.0	0.6	84.0	☆	★	☆
JVR 14N 331K	330	±10%	210	275	550	50	4500	3.0	0.6	92.0	☆	★	☆
JVR 14N 361K	360	±10%	230	300	595	50	4500	3.0	0.6	104.0	☆	★	☆
JVR 14N 391K	390	±10%	250	320	650	50	4500	3.0	0.6	120.0	☆	★	☆
JVR 14N 431K	430	±10%	275	350	710	50	4500	3.0	0.6	132.0	☆	★	☆
JVR 14N 471K	470	±10%	300	385	775	50	4500	3.0	0.6	140.0	☆	★	☆
JVR 14N 511K	510	±10%	320	418	842	50	4500	3.0	0.6	148.0	☆	★	☆
JVR 14N 561K	560	±10%	350	460	920	50	4500	3.0	0.6	156.0	☆	★	☆
JVR 14N 621K	620	±10%	385	505	1025	50	4500	3.0	0.6	164.0	☆	★	☆
JVR 14N 681K	680	±10%	420	560	1120	50	4500	3.0	0.6	172.0	☆	★	☆
JVR 14N 751K	750	±10%	460	615	1240	50	4500	3.0	0.6	180.0	☆	★	☆
JVR 14N 781K	780	±10%	485	640	1290	50	4500	3.0	0.6	184.0	☆	★	☆
JVR 14N 821K	820	±10%	510	670	1355	50	4500	3.0	0.6	188.0	☆	★	☆
JVR 14N 911K	910	±10%	550	745	1500	50	4500	3.0	0.6	204.0	☆	★	☆
JVR 14N 102K	1000	±10%	625	825	1650	50	4500	3.0	0.6	224.0	☆	★	☆
JVR 14N 112K	1100	±10%	680	895	1815	50	4500	3.0	0.6	248.0	☆	★	☆
JVR 14N 122K	1200	±10%	720	975	1980	50	4500	2.0	0.6	268.0	☆	★	☆
JVR 14N 142K	1400	±10%	825	1135	2310	50	4500	2.0	0.6	300.0	☆	★	☆
JVR 14N 162K	1600	±10%	920	1300	2640	50	4500	2.0	0.6	328.0	☆	★	☆
JVR 14N 182K	1800	±10%	1000	1465	2970	50	4500	2.0	0.6	348.0	☆	★	☆

過電壓保護



Pulse Life time Ratings-14mm
14N 180M~14N 680K

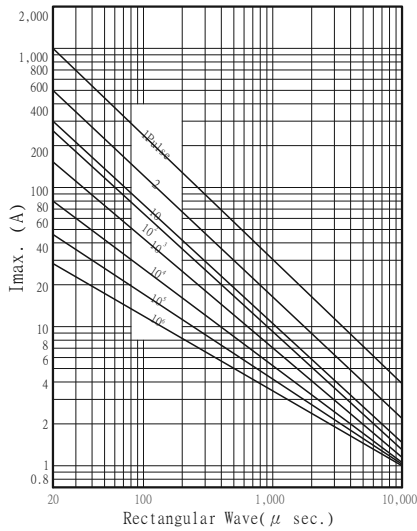

V-I Characteristic Curve-14mm
14N 180M~14N 680K

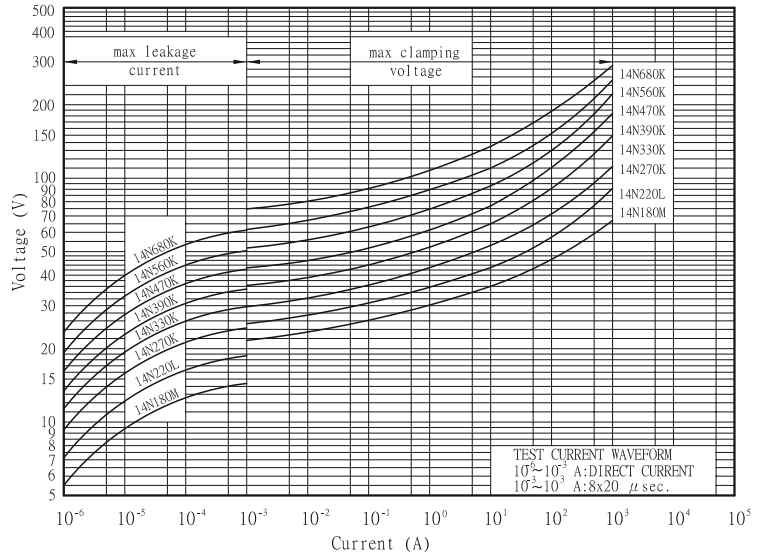

14N 820K~14N 471K

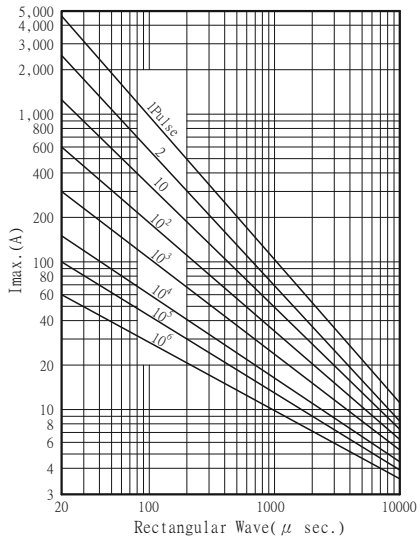

14N 820K~14N 471K

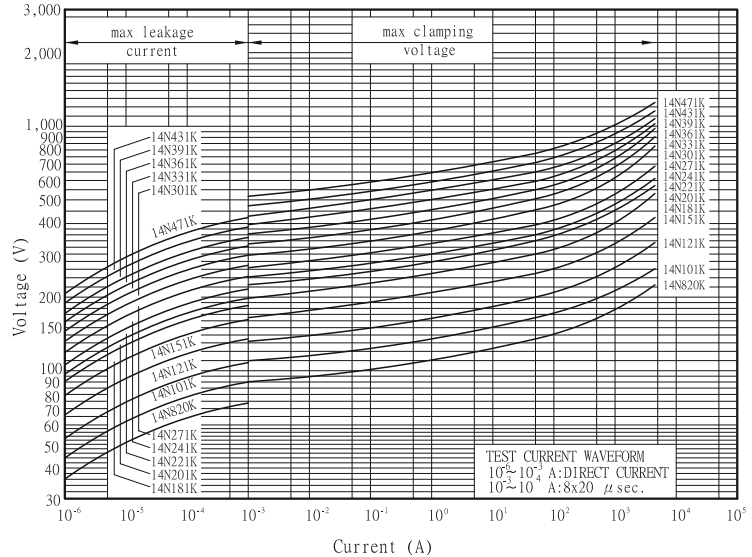

14N 511K~14N 182K

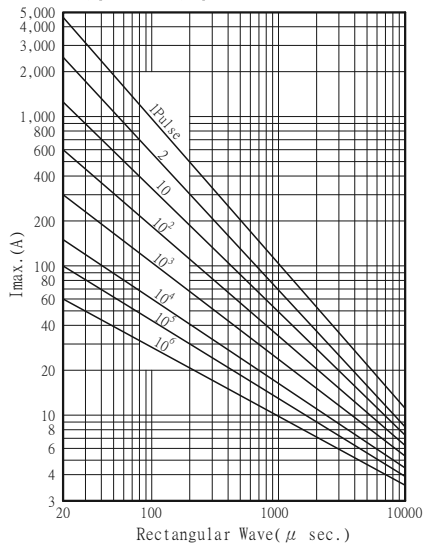

14N 511K~14N 182K

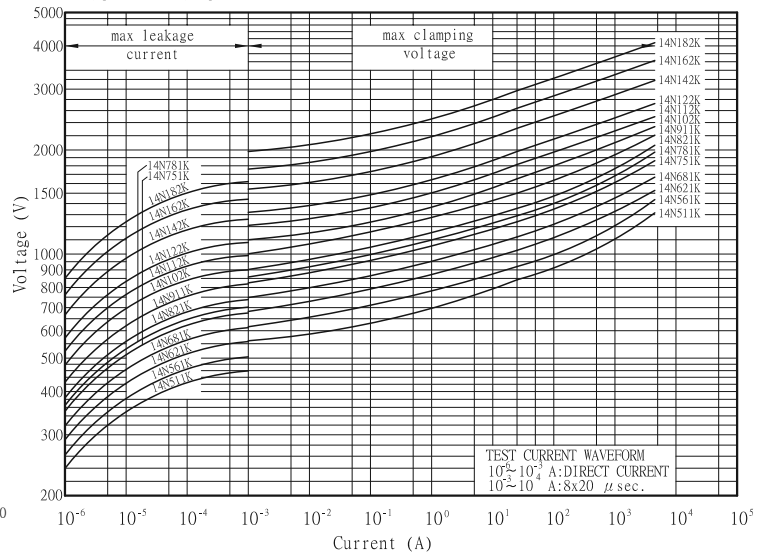

過電壓保護



RATING AND CHARACTERISTICS

Standard Varistors-20mm

Part No.	Varistor Voltage at 1mA		Maximum Allowable Voltage		Maximum Clamping Voltage		Withstanding Surge Current (8/20us)	Nominal Discharge Current (8/20us)	Rated Wattage	Energy (10/1000us)	Certification		
	DC (V)	Tolerance	AC rms (V)	DC (V)	V@ ic (V)	ic (A)	1 Time (A)	In (KA)	(W)	(J)	UL	US	CEC
JVR20N 220M	22	±20%	14	18	43	20	2000	2	0.2	8.0	☆	☆	☆
JVR20N 270M	27	±20%	17	22	53	20	2000	2	0.2	10.0	☆	☆	☆
JVR20N 330M	33	±20%	20	26	65	20	2000	2	0.2	12.0	☆	☆	☆
JVR20N 390L	39	±15%	25	31	77	20	2000	2	0.2	14.0	☆	☆	☆
JVR20N 470L	47	±15%	30	38	93	20	2000	2	0.2	17.0	☆	☆	☆
JVR20N 560L	56	±15%	35	45	110	20	2000	2	0.2	20.0	☆	☆	☆
JVR20N 680L	68	±15%	40	56	135	20	2000	2	0.2	24.0	☆	☆	☆
JVR20N 820L	82	±15%	50	65	135	100	6500	4	1	44.0	☆	☆	☆
JVR20N 101K	100	±10%	60	85	165	100	6500	4.0	1	56.0	☆	☆	☆
JVR20N 121K	120	±10%	75	100	200	100	6500	4.0	1	64.0	☆	☆	☆
JVR20N 151K	150	±10%	95	125	250	100	6500	4.0	1	88.0	☆	☆	☆
JVR20N 181K	180	±10%	115	150	300	100	6500	4.0	1	104.0	☆	★	☆
JVR20N 201K	200	±10%	130	170	340	100	6500	4.0	1	114.0	☆	★	★
JVR20N 221K	220	±10%	140	180	360	100	6500	4.0	1	124.0	☆	★	★
JVR20N 241K	240	±10%	150	200	395	100	6500	4.0	1	134.0	☆	★	★
JVR20N 271K	270	±10%	175	225	455	100	6500	4.0	1	158.0	☆	★	★
JVR20N 301K	300	±10%	195	250	505	100	6500	4.0	1	168	☆	★	★
JVR20N 331K	330	±10%	210	275	550	100	6500	4.0	1	184.0	☆	★	★
JVR20N 361K	360	±10%	230	300	595	100	6500	4.0	1	208.0	☆	★	★
JVR20N 391K	390	±10%	250	320	650	100	6500	4.0	1	240.0	☆	★	★
JVR20N 431K	430	±10%	275	350	710	100	6500	4.0	1	264.0	☆	★	★
JVR20N 471K	470	±10%	300	385	775	100	6500	4.0	1	280.0	☆	★	★
JVR20N 511K	510	±10%	320	418	842	100	6500	4.0	1	296.0	☆	★	★
JVR20N 561K	560	±10%	350	460	920	100	6500	4.0	1	312.0	☆	★	★
JVR20N 621K	620	±10%	385	505	1025	100	6500	4.0	1	328.0	☆	★	★
JVR20N 681K	680	±10%	420	560	1120	100	6500	4.0	1	344.0	☆	★	★
JVR20N 751K	750	±10%	460	615	1240	100	6500	4.0	1	360.0	☆	★	★
JVR20N 781K	780	±10%	485	640	1290	100	6500	4.0	1	368.0	☆	★	★
JVR20N 821K	820	±10%	510	670	1355	100	6500	4.0	1	376.0	☆	★	★
JVR20N 911K	910	±10%	550	745	1500	100	6500	4.0	1	408.0	☆	★	★
JVR20N 102K	1000	±10%	625	825	1650	100	6500	4.0	1	448.0	☆	★	★
JVR20N 112K	1100	±10%	680	895	1815	100	6500	4.0	1	496.0	☆	★	★
JVR20N 122K	1200	±10%	720	975	1980	100	6500	3.0	1	528.0	☆	★	★
JVR20N 142K	1400	±10%	825	1135	2310	100	6500	3.0	1	596.0	☆	★	★
JVR20N 162K	1600	±10%	920	1300	2640	100	6500	3.0	1	656.0	☆	★	★
JVR20N 182K	1800	±10%	1000	1465	2970	100	6500	3.0	1	695.0	☆	★	★

過電壓保護



Pulse Life time Ratings-20mm
20N 220M~20N 680L

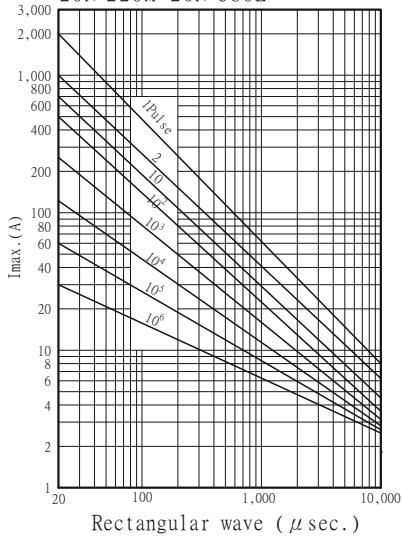

V-I Characteristic Curve-20mm
20N 220M~20N 680L

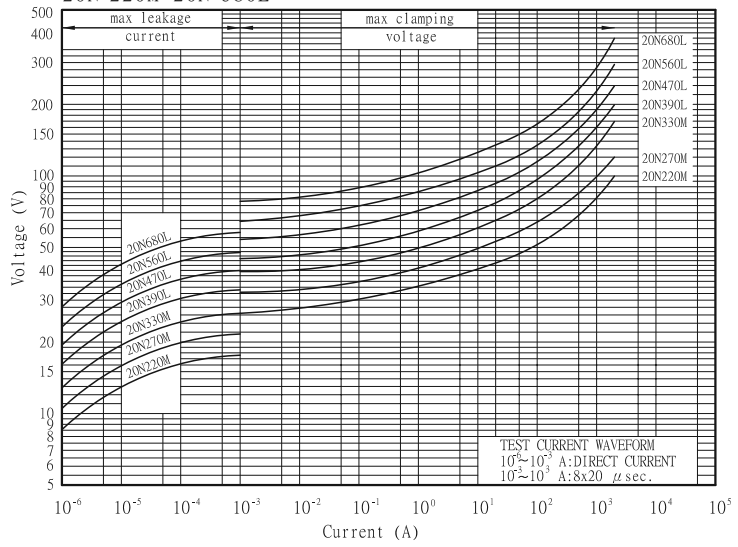

20N 101K~20N 471K

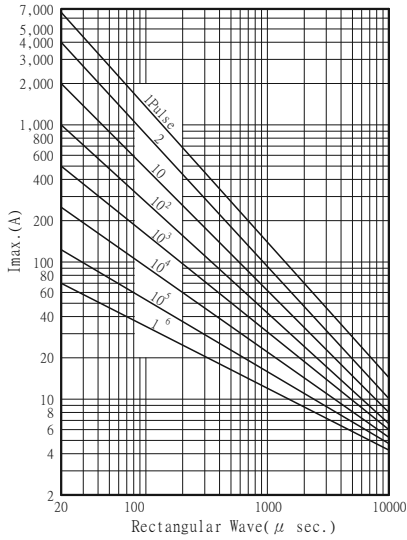

20N 101K~20N 471K

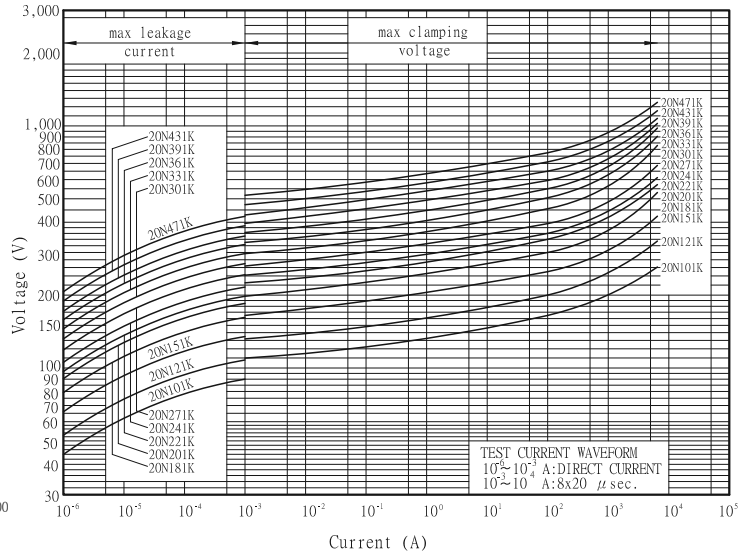

20N 511K~20N 182K

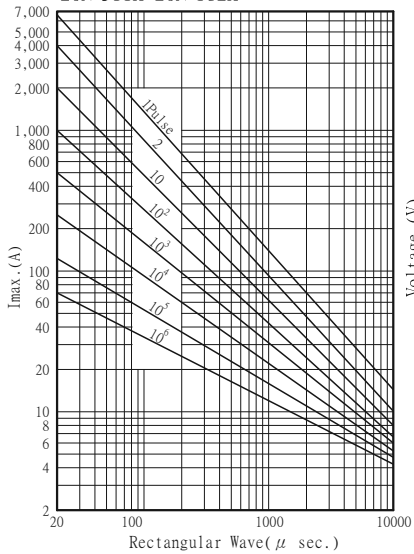

20N 511K~20N 182K

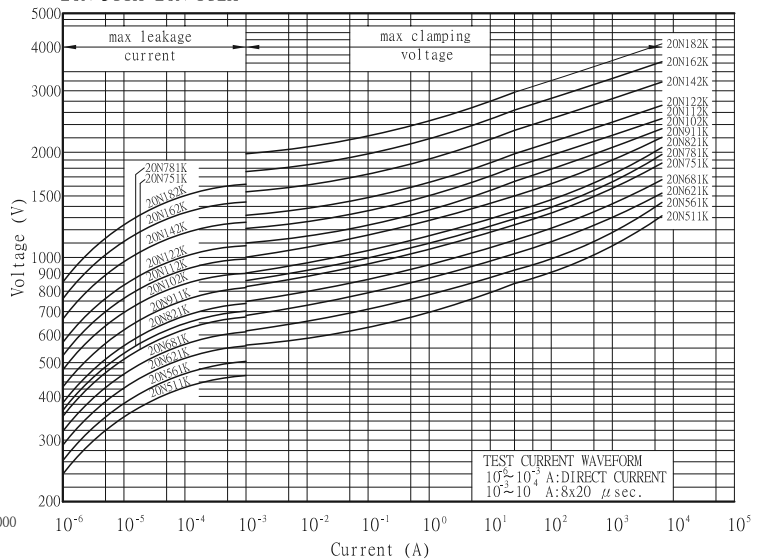

過電壓保護



RATING AND CHARACTERISTICS

Standard Varistors - 25mm

Part No.	Varistor Voltage at 1mA		Maximum Allowable Voltage		Maximum Clamping Voltage		Withstanding Surge Current (8/20us)	Nominal Discharge Current (8/20us)	Rated Wattage	Energy (10/1000us)	Certification	
	DC (V)	Tolerance	AC rms (V)	DC (V)	V@ ic (V)	ic (A)	1 Time (A)	In (KA)	(W)	(J)	UL US	CEC
JVR 25N 201K	200	±10%	130	170	355	150	20000	5	1.2	190.0	☆	★
JVR 25N 221K	220	±10%	140	180	380	150	20000	5	1.2	205.0	☆	★
JVR 25N 241K	240	±10%	150	200	415	150	20000	5	1.2	225.0	☆	★
JVR 25N 271K	270	±10%	175	225	445	150	20000	5	1.2	255.0	☆	★
JVR 25N 301K	300	±10%	195	250	495	150	20000	5	1.2	280.0	☆	★
JVR 25N 331K	330	±10%	210	275	545	150	20000	5	1.2	305.0	☆	★
JVR 25N 361K	360	±10%	230	300	595	150	20000	5	1.2	330.0	☆	★
JVR 25N 391K	390	±10%	250	320	645	150	20000	5	1.2	360.0	☆	★
JVR 25N 431K	430	±10%	275	350	710	150	20000	5.0	1.2	380.0	☆	★
JVR 25N 471K	470	±10%	300	385	775	150	20000	5.0	1.2	400.0	☆	★
JVR 25N 511K	510	±10%	320	418	840	150	20000	5.0	1.2	420.0	☆	★
JVR 25N 561K	560	±10%	350	460	925	150	20000	5.0	1.2	440.0	☆	★
JVR 25N 621K	620	±10%	385	505	1025	150	20000	5.0	1.2	460.0	☆	★
JVR 25N 681K	680	±10%	420	560	1125	150	20000	5.0	1.2	480.0	☆	★
JVR 25N 751K	750	±10%	460	615	1240	150	20000	5.0	1.2	520.0	☆	★
JVR 25N 781K	780	±10%	485	640	1290	150	20000	5.0	1.2	540.0	☆	★
JVR 25N 821K	820	±10%	510	670	1360	150	20000	5.0	1.2	570	☆	★
JVR 25N 911K	910	±10%	550	745	1500	150	20000	5.0	1.2	620.0	☆	★

過電壓保護



Pulse Life time Ratings-25mm
25N 201K-25N 471K

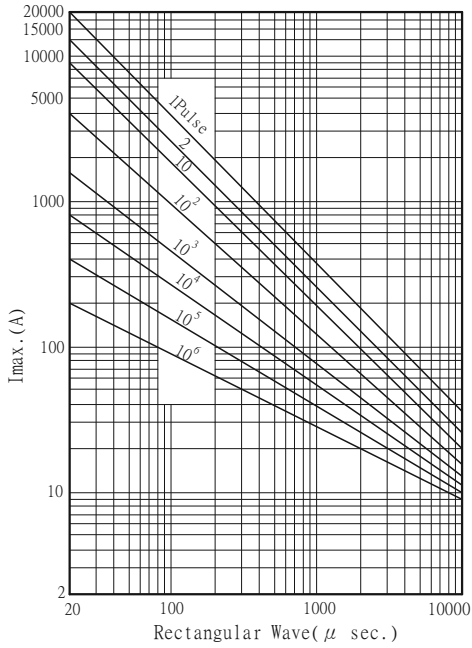

V-I Characteristic Curve-25mm
25N 201K-25N 471K

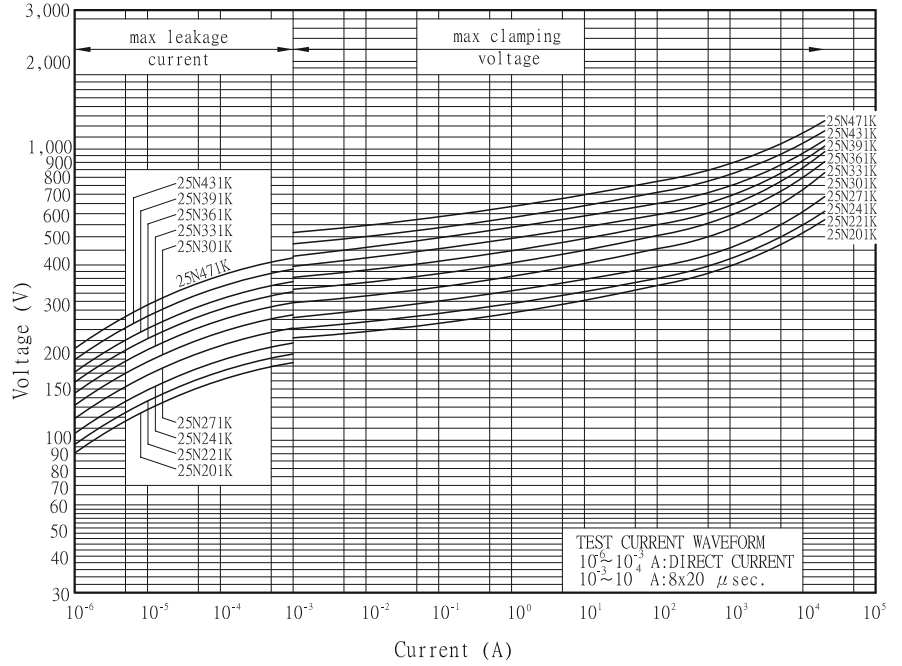

25N 511K~25N 911K

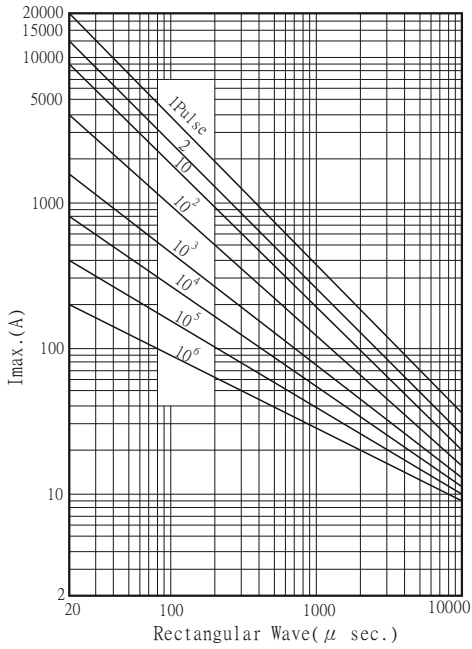

25N 511K~25N 911K

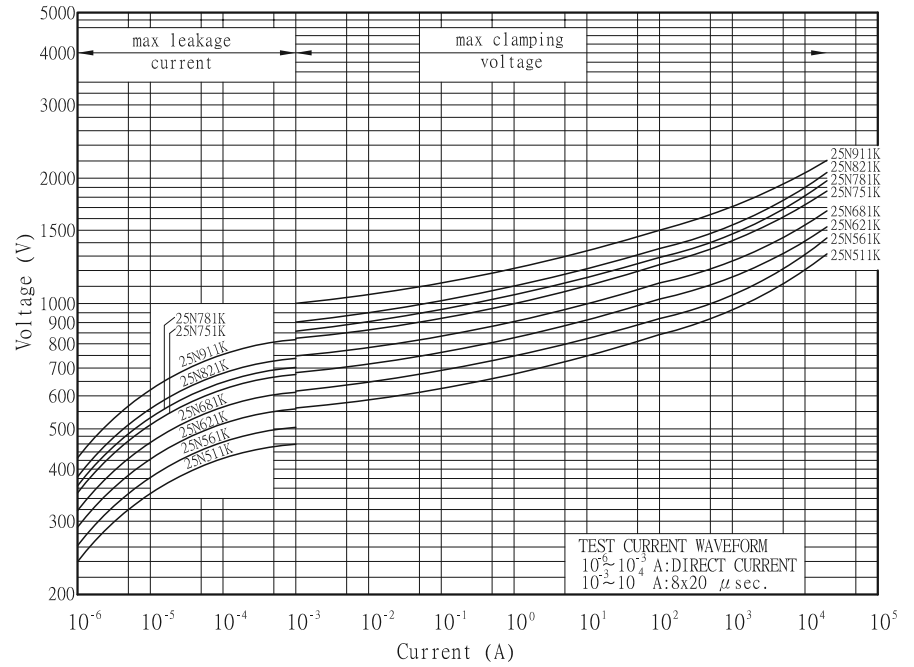

過電壓保護



JOYIN CO., LTD

Metal Oxide Varistor

■ Reliability-JVR

Test description	Standard	Test condition	Test requirement			
Tensile Strength of Terminals	IEC60068-2-21	After gradually applying the load specified below and keeping the unit fixed for 10±1 seconds.	No visible damage ΔVb% ≤ ±5%			
		<table border="1"> <tr> <th>Terminal diameter (mm)</th> <th>Force (Kg)</th> </tr> <tr> <td>0.5 < d ≤ 0.8</td> <td>1.0</td> </tr> <tr> <td>0.8 < d ≤ 1.25</td> <td>2.0</td> </tr> </table>		Terminal diameter (mm)	Force (Kg)	0.5 < d ≤ 0.8
Terminal diameter (mm)	Force (Kg)					
0.5 < d ≤ 0.8	1.0					
0.8 < d ≤ 1.25	2.0					
Bending Strength of Terminals	IEC60068-2-21	Hold specimen and apply the force specified below to each lead. Bend the specimen to 90°, then return to the original position. Repeat the procedure in the opposite direction.	No visible damage ΔVb% ≤ ±5%			
		<table border="1"> <tr> <th>Terminal diameter (mm)</th> <th>Force (Kg)</th> </tr> <tr> <td>0.5 < d ≤ 0.8</td> <td>0.5</td> </tr> <tr> <td>0.8 < d ≤ 1.25</td> <td>1.0</td> </tr> </table>		Terminal diameter (mm)	Force (Kg)	0.5 < d ≤ 0.8
Terminal diameter (mm)	Force (Kg)					
0.5 < d ≤ 0.8	0.5					
0.8 < d ≤ 1.25	1.0					
Vibration	IEC60068-2-6	Frequency range : 10Hz~55Hz Amplitude : 0.75mm or 98 m/s ² Direction : 3 mutually perpendicular directions, 2hrs each.	No visible damage ΔVb% ≤ ±5%			
Solderability	IEC60068-2-20	Bath temperature : 245±3°C Immersion time : 3±0.3 sec	At least 95% of terminal electrode is covered by new solder			
Resistance to soldering heat	IEC60068-2-20	Bath temperature : 260±3°C Immersion time : 10±1 sec (5N series 5±0.5s)	No visible damage ΔVb(1mA) ≤ ±5%			
Voltage Proof	IEC61051-1	The specified voltage is applied between both terminals of the component connected together for 1 minute .	No visible damage			
		<table border="1"> <tr> <th>2500Vrms(AC)</th> <th>Test Voltage(AC)</th> </tr> </table>		2500Vrms(AC)	Test Voltage(AC)	
2500Vrms(AC)	Test Voltage(AC)					
Rapid change of temperature	IEC60068-2-14	Temperature cycle shall be repeated 5 cycles 1.- 40±3°C keeping 30±3min 2.Room temperature keeping 5±3min 3.125±2°C keeping 30±3min 4.Room temperature keeping 5±3min	No visible damage ΔVb% ≤ ±5%			
Damp heat load	IEC60068-2-78	Temperature 40±2°C R.H.90~95% and the maximum Allowable voltage for 1000±24 hours	No visible damage ΔVb% ≤ ±10%			
Damp heat	IEC60068-2-78	Temperature 40±2°C R.H.90~95% for 1000±24 hours	No visible damage ΔVb% ≤ ±5%			
High temperature load	MIL-STD-202 Method 108	After being continuously applied the max allowable voltage at 85±2°C for 1000±24 hours	No visible damage ΔVb% ≤ ±10%			
High temperature storage	IEC60068-2-2	125±5°C for 1000±24 hours	No visible damage ΔVb% ≤ ±5%			
Low temperature storage	IEC60068-2-1	-40±2°C for 1000±24 hours	No visible damage ΔVb% ≤ ±5%			
Varistor Voltage Temp.Coefficient	Specification Standard	Measure V1mA at -40°C、25°C、125°C	-0.05 ≤ TC ≤ 0.05(%/°C)			
8/20μs Surge Life	IEC61051-1	8/20μs waveform, 10 surge current, unipolar, interval 30 secs, amplitude corresponding to max. surge current derating curves for 20 μs.	No visible damage ΔVb% ≤ ±10%			
10/1000μs Surge Life	IEC61051-1	10/1000μs waveform, 10 surge current, unipolar, interval 2 mins, amplitude corresponding to max. surge current derating curves for 1000 μs.	No visible damage ΔVb% ≤ ±10%			

Dimensions

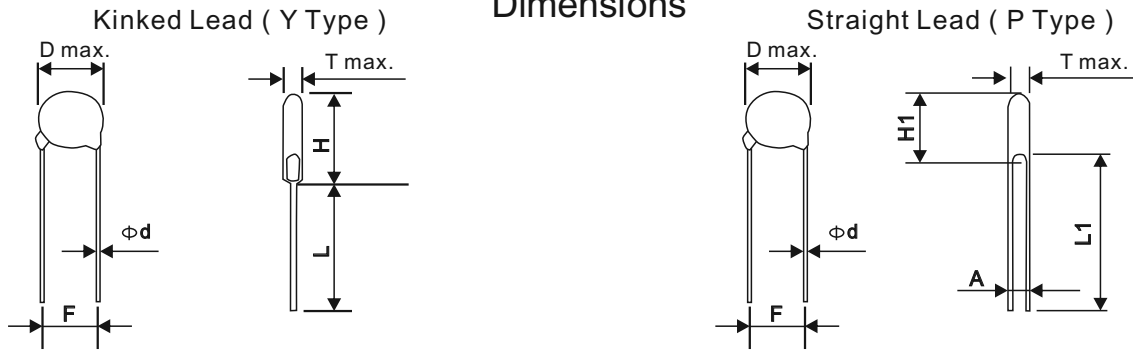

Dimensions Table

unit : mm

Diameter	5mm	7mm	10mm	14mm	20mm	25mm
D max.	7.5	9.0	12.5	16.5	23	29
d ± 0.05	0.6	0.6	0.8	0.8	1.0	1.0
F ± 1.0	5.0	5.0	7.5	7.5	10.0	10.0
H max.	11.0	12.5	17/*19	22/*23	28/*29	36
L1 min.	25.0	25.0	25.0	25.0	25.0	25.0
L min.	24.0	24.0	24.0	24.0	24.0	20.0

*Just for 182K

Table of Tmax, A&H1 max.

unit : mm

Diameter TypeNo.	5mm			7mm			10mm			14mm			20mm			25mm		
	T max.	A± 0.8	H1max.	T max.	A± 0.8	H1max.	T max.	A± 0.8	H1max.	T max.	A± 0.8	H1max.	T max.	A± 0.8	H1max.	T max.	A± 0.8	H1max.
180M	3.9	0.8	10.5	3.9	0.8	12.0	4.3	0.8	15.0	4.3	0.9	19.5	/	/	/	/	/	/
220M/L	4.1	0.9	10.5	4.1	0.9	12.0	4.5	0.9	15.0	4.5	1.0	19.5	4.9	1.0	26.5	/	/	/
270M/K	4.3	0.9	10.5	4.3	0.9	12.0	4.7	0.9	15.0	4.7	1.0	19.5	5.1	1.1	26.5	/	/	/
330M/K	4.5	1.0	10.5	4.5	1.0	12.0	4.9	1.0	15.0	4.9	1.2	19.5	5.3	1.2	26.5	/	/	/
390L/K	4.5	1.2	10.5	4.5	1.2	12.0	5.1	1.2	15.0	5.1	1.4	19.5	5.4	1.4	26.5	/	/	/
470L/K	4.8	1.2	10.5	4.8	1.2	12.0	5.3	1.2	15.0	5.4	1.4	19.5	5.6	1.4	26.5	/	/	/
560L/K	4.8	1.4	10.5	4.8	1.4	12.0	5.5	1.4	15.0	5.6	1.6	19.5	5.6	1.6	26.5	/	/	/
680L/K	5.1	1.7	10.5	5.1	1.7	12.0	5.7	1.6	15.0	5.6	1.9	19.5	5.9	1.9	26.5	/	/	/
820K	3.8	0.8	10.5	3.8	0.8	12.0	4.3	0.8	15.0	4.3	1.0	19.5	4.7	1.1	26.5	/	/	/
101K	3.9	0.8	10.5	3.9	0.8	12.0	4.4	0.8	15.0	4.5	1.0	19.5	4.9	1.2	26.5	/	/	/
121K	4.1	0.9	10.5	4.1	0.9	12.0	4.5	0.9	15.0	4.6	1.1	19.5	5.1	1.3	26.5	/	/	/
151K	4.5	1.2	10.5	4.5	1.2	12.0	4.9	1.2	15.0	5.0	1.4	19.5	5.4	1.6	26.5	/	/	/
181K	3.9	1.0	10.5	3.9	1.0	12.0	4.3	1.0	15.0	4.3	1.2	19.5	5.0	1.4	26.5	/	/	/
201K	4.0	1.0	10.5	4.0	1.0	12.0	4.4	1.0	15.0	4.4	1.2	19.5	5.1	1.4	26.5	5.4	2.5	35
221K	4.0	1.1	10.5	4.0	1.1	12.0	4.4	1.1	15.0	4.4	1.3	19.5	5.2	1.5	26.5	5.6	2.6	35
241K	4.2	1.1	10.5	4.2	1.3	12.0	4.6	1.3	15.0	4.6	1.5	19.5	5.3	1.7	26.5	5.7	2.8	35
271K	4.4	1.3	10.5	4.4	1.4	12.0	4.8	1.4	15.0	4.8	1.5	19.5	5.5	1.9	26.5	6.0	3.0	35
301K	4.4	1.3	10.5	4.4	1.5	12.0	4.8	1.6	15.0	4.8	1.7	19.5	5.7	2.1	26.5	6.3	3.2	35
331K	4.5	1.3	10.5	4.5	1.5	12.0	4.9	1.6	15.0	4.9	1.7	19.5	5.8	2.1	26.5	6.6	3.4	35
361K	4.7	1.8	10.5	4.6	1.9	12.0	5.0	1.9	15.0	5.0	2.1	19.5	6.0	2.3	26.5	6.8	3.6	35
391K	4.8	2.0	11.0	4.8	2.0	12.5	5.2	2.2	15.0	5.2	2.2	19.5	6.2	2.4	26.5	7.1	3.9	35
431K	5.1	2.1	11.0	5.1	2.0	12.5	5.5	2.5	15.0	5.5	2.5	19.5	6.6	2.7	26.5	7.2	3.3	35
471K	5.2	2.2	11.0	5.2	2.3	12.5	5.6	2.6	15.0	5.6	2.7	19.5	6.8	2.9	27.0	7.4	3.5	35
511K	5.6	2.5	11.5	5.6	2.5	12.5	5.8	3.1	15.0	5.8	3.1	20.0	7.0	3.3	27.0	7.6	3.8	35
561K	5.7	2.8	11.5	5.7	2.8	12.5	6.1	3.4	15.0	6.1	3.4	20.0	7.3	3.6	27.0	7.9	4.0	35
621K	6.0	3.1	11.5	6.0	3.1	12.5	6.4	4.0	15.0	6.4	3.8	20.0	7.6	4.1	27.0	8.2	4.4	35
681K	6.3	3.4	11.5	6.3	3.4	12.5	6.8	4.4	15.0	6.8	4.1	20.0	8.0	4.4	27.0	8.3	4.7	35
751K	6.7	3.7	11.5	6.8	3.7	12.5	7.2	4.4	15.0	7.2	4.3	20.0	8.4	4.5	27.0	8.7	5.0	35
781K	/	/	/	7.0	3.9	12.5	7.3	4.6	15.0	7.3	4.6	20.0	8.6	4.8	27.0	8.9	5.2	35
821K	/	/	/	7.2	4.1	12.5	7.6	4.6	15.0	7.6	4.6	20.0	8.8	4.8	27.0	9.1	5.4	35
911K	/	/	/	/	/	/	8.2	5.4	16.0	8.2	5.4	20.5	9.3	5.7	27.0	9.6	5.9	35
102K	/	/	/	/	/	/	8.5	5.4	16.0	8.6	5.6	20.5	9.9	5.8	27.0	/	/	/
112K	/	/	/	/	/	/	9.1	5.7	16.0	9.1	6.1	20.5	10.3	6.3	27.0	/	/	/
122K	/	/	/	/	/	/	9.9	6.3	17.0	10.0	6.7	21.0	11.3	6.9	27.5	/	/	/
142K	/	/	/	/	/	/	10.7	7.4	17.5	10.9	7.8	21.5	12.8	8.0	28.0	/	/	/
162K	/	/	/	/	/	/	11.5	8.6	17.5	11.8	9.0	21.5	13.0	9.2	28.5	/	/	/
182K	/	/	/	/	/	/	12.6	9.8	17.5	12.8	10.2	21.5	13.5	10.4	29.0	/	/	/

Tape and Reel Dimensions

1/2" pitch

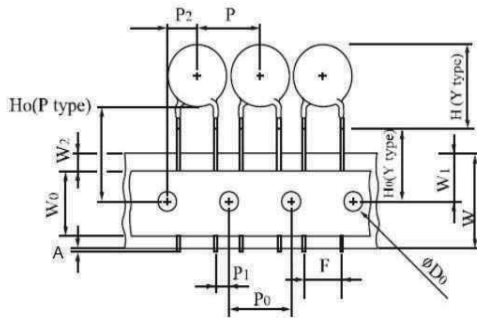

1.0" pitch

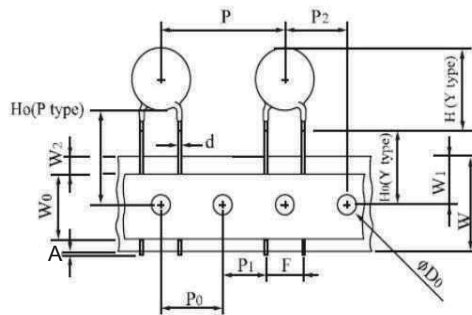

Symbols	Item	5 / 7 mm	10 / 14 mm	20 mm
A	Cut out length	1.1 mm max.	1.1 mm max.	
H (Y type)	Height of Top	See H max. table		
H0(Y type)	Height to seating plane	16.0 ± 0.5 mm (* ± 1.0 mm)	16.0 ± 0.5 mm (* ± 1.0 mm)	
H0(P type)	Height of component from hole center	16.0 ~ 21.0 mm	16.0 ~ 21.0 mm	
Δh	Front to back deviation	0 ± 2.0 mm	0 ± 2.0 mm	
W	Carrier tape width	18 ^{+1.0} _{-0.5} mm	18 ^{+1.0} _{-0.5} mm	
W0	Hold down tape width	10.0 mm	12.0 mm	
W1	Sprocket hole position	9.0 ^{+0.75} _{-0.5} mm	9.0 ^{+0.75} _{-0.5} mm	
W2	Adhesive tape position	3.0 mm max.	3.0 mm max.	
F	Component lead spacing	5.0 ± 1.0 mm	7.5 ± 1.0 mm	10.0 ± 1.0 mm
P	Pitch of component	12.7 ± 1.0 mm	25.4 ± 1.0 mm	
P0	Sprocket hole pitch	12.7 ± 0.3 mm	12.7 ± 0.3 mm	
P1	Lead length from hole center to lead	3.85 ± 0.7 mm	8.95 ± 0.7 mm	7.7 ± 0.7 mm
P2	Length from hole center to disk center	6.35 ± 1.3 mm	12.7 ± 1.3 mm	
D0	Sprocket hole diameter	4.0 ± 0.2 mm	4.0 ± 0.2 mm	
d	Lead wire diameter	0.6 ± 0.05 mm	0.8 ± 0.05 mm	1.0 ± 0.05 mm
T	Disk thickness	See Tmax. table	See T max. table	
t1	Total thickness tape	0.7 ± 0.05 mm	0.7 ± 0.05 mm	
t2	Total thickness	1.6 mm max.	1.8 mm max.	

Marking & packaging

MARKING

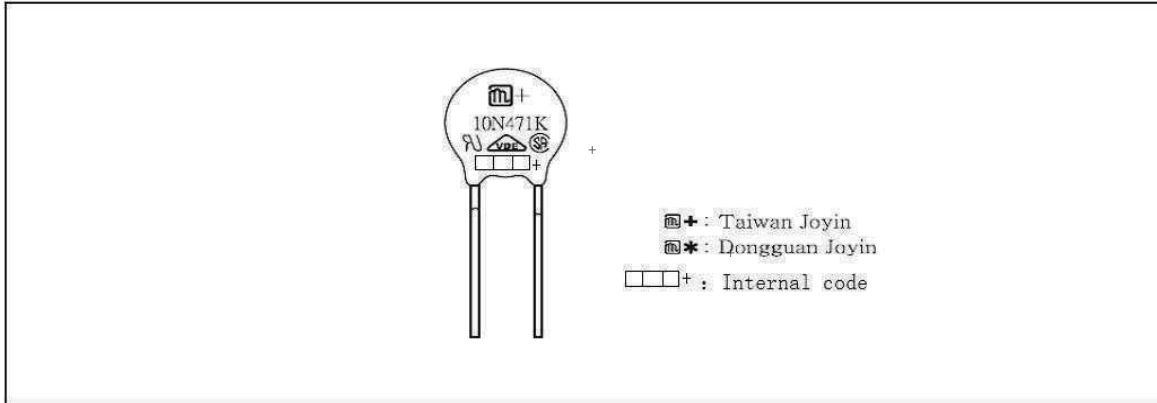

PACKAGING

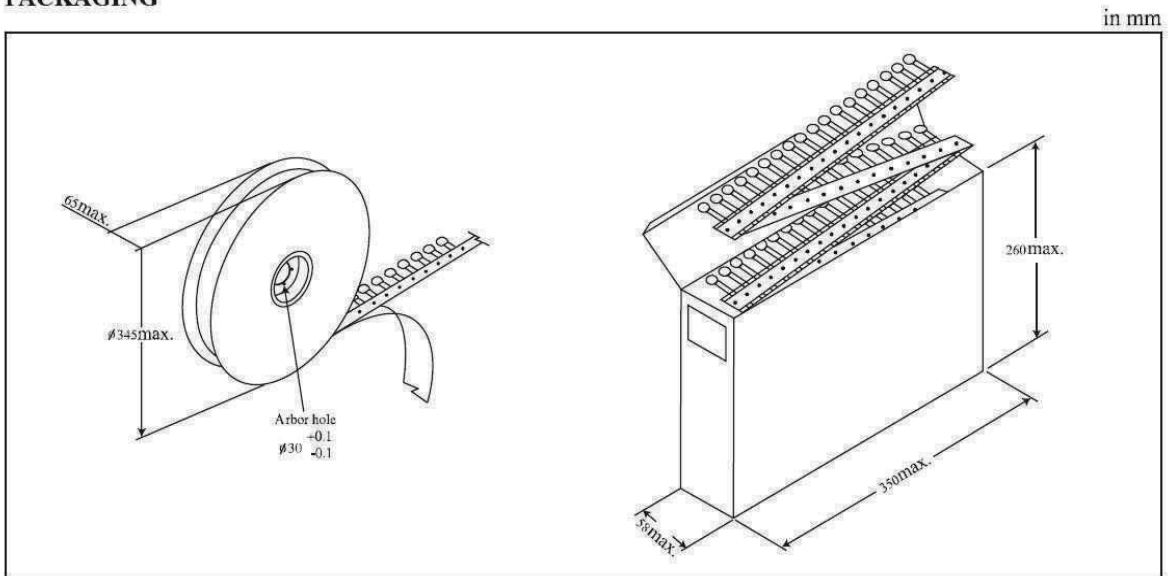

Quantity per Packing Unit

in Pcs

Part No.	5 mm			7 mm			10 mm			14 mm			20 mm			25 mm
	Bulk (Box)	Reel	Ammo	Bulk (Box)	Reel	Ammo	Bulk (Box)	Reel	Ammo	Bulk (Box)	Reel	Ammo	Bulk (Box)	Reel	Ammo	Bulk (Box)
180M~ 470K	5000	1500	1500	5000	1500	1500	2500	1000	500	1500	750	500	750	500	500	-
560K ~ 680K	5000	1500	1000	5000	1500	1000	2500	1000	500	1500	750	500	750	500	500	-
820K ~ 391K	5000	1500	1500	5000	1500	1500	2500	1000	500	1500	750	500	750	500	500	750
431K ~ 471K	5000	1500	1000	5000	1000	1000	2000	750	500	1500	750	500	750	500	500	750
511K ~ 821K	4000	1000	1000	4000	1000	1000	1500	500	500	750	500	500	450	500	500	450
911K ~ 122K	-	-	-	-	-	-	1500	500	350	750	500	350	450	-	-	450
142K ~ 182K	-	-	-	-	-	-	750	-	-	450	-	-	300	-	-	-

Packaging	Bulk (Box)	Reel	Reel (14 mm, 20mm)	Ammo (5 mm, 7 mm)	Ammo (10 mm, 14 mm)	Ammo (20 mm)
Box size (mm)	290× 155× 110	350× 350× 105	346× 346× 72	335× 245× 43	347× 246× 50	348× 255× 60
Carton size (mm)	328× 310× 250	370× 370× 590	370× 370× 468	515× 354× 258	515× 364× 246	535× 365× 275
One carton with	4 Boxes	5 Boxes (10 reels)	6 Boxes (6 reels)	10 Boxes	8 Boxes	8 Boxes

X-ON Electronics

Largest Supplier of Electrical and Electronic Components

Click to view similar products for [Varistors](#) category:

Click to view products by [Joyin](#) manufacturer:

Other Similar products are found below :

[R71ZOV151HC](#) [B72205S271K111](#) [B72214S110K151](#) [B72214S151K531](#) [B72214S251K151](#) [B72540E250K62](#) [NTE1V020](#) [NTE1V130](#)
[25FN511K](#) [S10K11G5S5](#) [ERZ-C14DK361U](#) [ERZ-C20DK221U](#) [207869-1](#) [AS-13](#) [B72214S200K551](#) [B72540E 350K 62](#) [B72590D360A60](#)
[B72650M301K93](#) [B72670M1140K72](#) [TVZ18EC271KBS](#) [TVZ20EB911KBS](#) [TVZ25D201KBS](#) [TVZ25D241KBS](#) [VDRH20X230BSE](#)
[VZ07D220KBS](#) [VZ40D241KQ-N](#) [VZ40D241K](#) [VZ25D511KBS-N](#) [VZ20E511KBSX](#) [VZ20E221KBSX](#) [VZ10D471KBS-N](#) [20A9FN241K](#)
[B72214S110K551](#) [B72650M350K72](#) [TVZ25D301KBS](#) [TVZ20EC911KBS](#) [TVZ20EBN911KBS](#) [TVZ18EC471KBS](#) [B72220S350K101](#)
[B72540E300K62](#) [NTE1V030](#) [NTE1V275](#) [NTE2V015](#) [NTE2V035](#) [NTE2V115](#) [VZ20D391KBS-N](#) [VZ10D241KBS-N](#) [VZ07D390KBS-N](#)
[VDRH14V060TSE](#) [VDRH20X300BKE](#)