

## LOW-NOISE DUAL OPERATIONAL AMPLIFIER

### ■ GENERAL DESCRIPTION

The NJM2068 is a high performance, low noise dual operational amplifier. This amplifier features popular pin-out, superior noise performance, and superior total harmonic distortion. This amplifier also features guaranteed noise performance with substantially higher gain-bandwidth product and slew rate, which far exceeds that of the 4558 type amplifier.

The specially designed low noise input transistors allow the NJM2068 to be used in very low noise signal processing applications such as audio preamplifiers and servo error amplifier.

The D-Rank type products(NJM2068DD/LD/MD) have specified maximum limits for equivalent input noise voltage.

### ■ PACKAGE OUTLINE

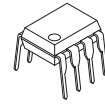

NJM2068D  
(DIP8)



NJM2068M  
(DMP8)



NJM2068V  
(SSOP8)

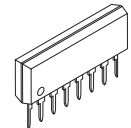

NJM2068L  
(SIP8)

### ■ FEATURES

- Operating Voltage ±4V~±18V
- Low Total Harmonic Distortion 0.001%
- Low Noise Voltage 0.56μV (FLAT+JISA)
- High Slew Rate 6V/μs
- Unity Gain Bandwidth 27MHz (f=10kHz)
- Bipolar Technology
- Package Outline DIP8, DMP8, SIP8, SSOP8

### ■ PIN CONFIGURATION

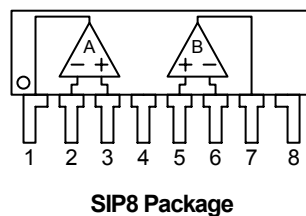
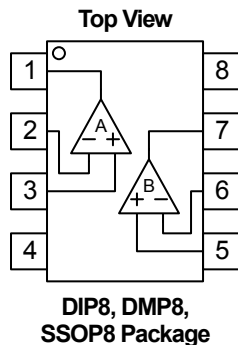

- PIN FUNCTION
- 1.A OUTPUT
  - 2.A -INPUT
  - 3.A +INPUT
  - 4.V<sup>-</sup>
  - 5.B +INPUT
  - 6.B -INPUT
  - 7.B OUTPUT
  - 8.V<sup>+</sup>

### ■ EQUIVALENT CIRCUIT ( 1/2 Shown )

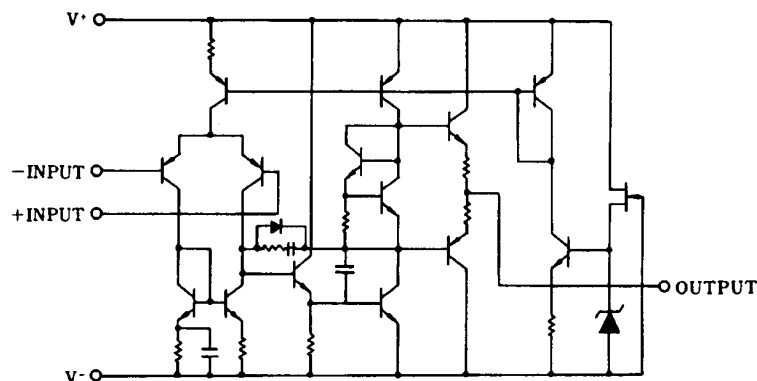

# NJM2068

## ■ ABSOLUTE MAXIMUM RATINGS(Ta=25°C)

PARAMETER	SYMBOL	RATING	UNIT
Supply Voltage	V <sup>+</sup> /V	±18	V
Differential Input Voltage Range	V <sub>ID</sub>	±30	V
Common Mode Input Voltage Range	V <sub>IC</sub>	±15 (Note1)	V
Power Dissipation	P <sub>D</sub>	DIP8: 500 DMP8: 300 SSOP8: 250 SIP8: 800	mW
Operating Temperature Range	T <sub>opr</sub>	-20~+75	°C
Storage Temperature Range	T <sub>stg</sub>	-40~+125	°C

(Note1) For supply voltage less than ±15V, the absolute maximum input voltage is equal to supply voltage.

## ■ RECOMMENDED OPERATING VOLTAGE(Ta=25°C)

PARAMETER	SYMBOL	TEST CONDITION	MIN.	TYP.	MAX.	UNIT
Supply Voltage	V <sup>+</sup> /V		±4	-	±18	V

## ■ ELECTRICAL CHARACTERISTICS(V<sup>+</sup>/V=±15V, Ta=25°C, unless otherwise noted.)

PARAMETER	SYMBOL	TEST CONDITION	MIN.	TYP.	MAX.	UNIT
Input Offset Voltage	V <sub>IO</sub>	R <sub>S</sub> ≤10kΩ	-	0.3	3	mV
Input Offset Current	I <sub>IO</sub>		-	5	200	nA
Input Bias Current	I <sub>B</sub>		-	150	1000	nA
Input Resistance	R <sub>IN</sub>		50	300	-	kΩ
Voltage Gain	A <sub>V</sub>	R <sub>L</sub> ≥2kΩ, V <sub>O</sub> =±10V	90	120	-	dB
Maximum Output Voltage	V <sub>OM</sub>	R <sub>L</sub> ≥2kΩ	±12	±13.5	-	V
Common Mode Input Voltage	V <sub>ICM</sub>		±12	±13.5	-	V
Common Mode Rejection Ratio	CMR	R <sub>S</sub> ≤10kΩ	80	110	-	dB
Supply Voltage Rejection Ratio	SVR	R <sub>S</sub> ≤10kΩ	80	120	-	dB
Slew Rate	SR	R <sub>L</sub> ≥2kΩ	-	6	-	V/μs
Gain Bandwidth Product1	G <sub>B1</sub>	f=10kHz	-	27	-	MHz
Gain Bandwidth Product2	G <sub>B2</sub>	f=100kHz	-	19	-	MHz
Unity Gain Frequency	f <sub>T</sub>	A <sub>V</sub> =1	-	5.5	-	MHz
Total Harmonic Distortion	THD	A <sub>V</sub> =20dB, V <sub>O</sub> =5V, R <sub>L</sub> =2kΩ, f=1kHz	-	0.001	-	%
Equivalent Input Noise Voltage	V <sub>NI</sub>	FLAT+JIS A, R <sub>S</sub> =300Ω	-	0.44	0.56	μV
Supply Current	I <sub>CC</sub>		-	5	8	mA

## ■ ELECTRICAL CHARACTERISTICS (D-Rank type(Note2), V<sup>+</sup>/V=±15V, Ta=25°C, unless otherwise noted.)

PARAMETER	SYMBOL	TEST CONDITION	MIN.	TYP.	MAX.	UNIT
Equivalent Input Noise Voltage	V <sub>NI</sub>	RIAA, R <sub>S</sub> =2.2kΩ	-	-	1.4	μV

(Note2)D-rank type is a Equivalent Input Noise Voltage selected product. It s only DIP, DMP and SIP package.

## ■ NOTICE

Oscillation might be caused when capacitor type load were connected. It is recommendable to insert series resistor (about 50Ω) at the output for preventing oscillation.

## ■ TYPICAL CHARACTERISTICS

**40dB Gain/Phase vs. Frequency**  
 $V^+/V^-=\pm 15V, R_L=2k\Omega, C_L=100pF, T_a=25^\circ C$

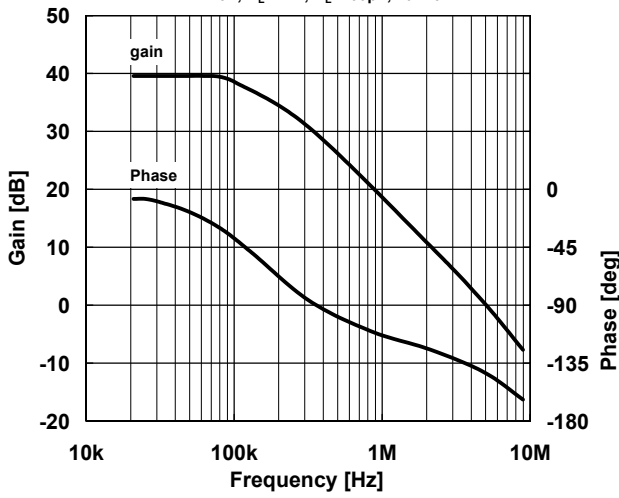

**Maximum Output Voltage vs. Frequency**  
 $V^+/V^-=\pm 15V, R_L=2k\Omega, T_a=25^\circ C$

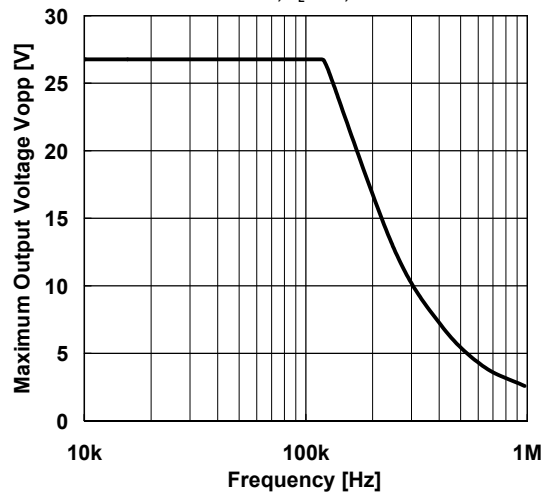

**Maximum Output Voltage vs. Output Current**  
 $V^+/V^-=\pm 15V, T_a=25^\circ C$

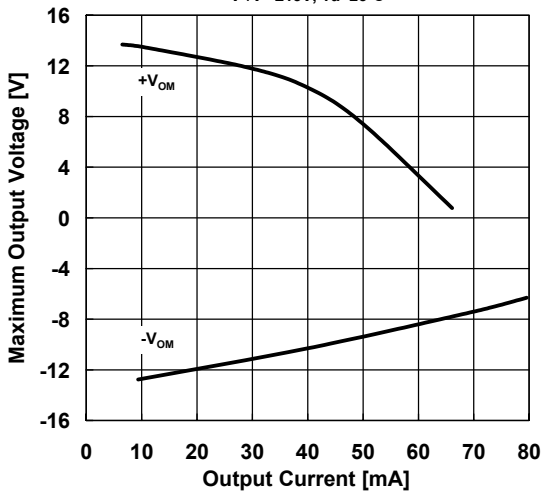

**Maximum Output Voltage vs. Load Resistance**  
 $V^+/V^-=\pm 15V, T_a=25^\circ C$

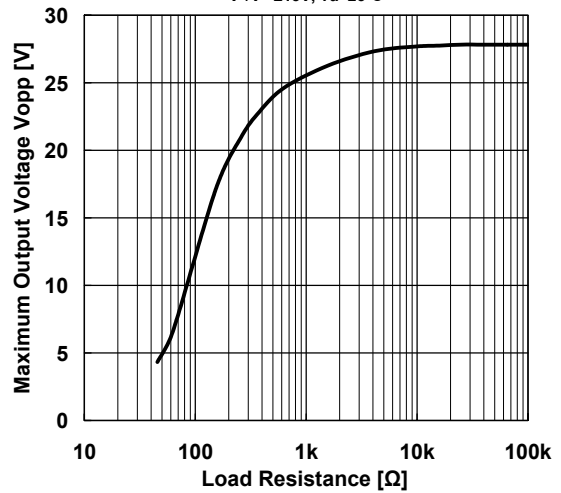

**Voltage Noises. Source Resistance**  
 $V^+/V^-=\pm 15V, JIS A, T_a=25^\circ C$

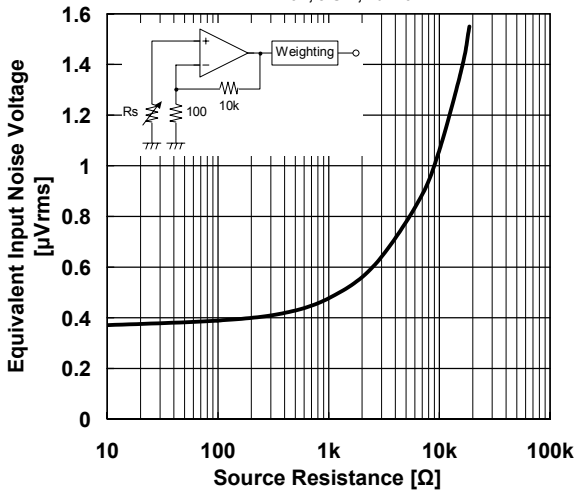

**Supply Current vs. Supply Voltage**  
 No Signal,  $R_L=\infty, T_a=25^\circ C$

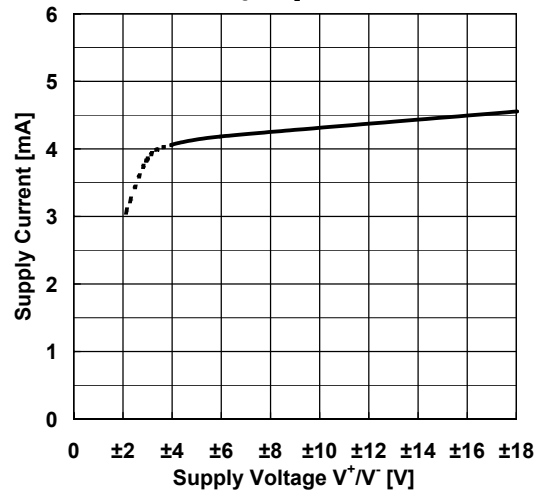

## ■ TYPICAL CHARACTERISTICS

Supply Current vs. Temperature  
 $V^+/V^-=\pm 15V$

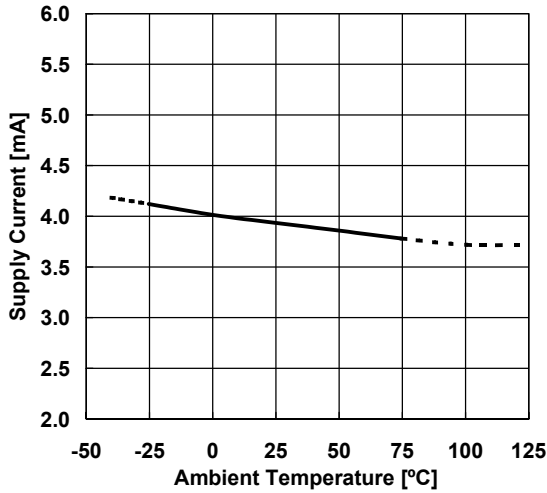

Input Offset Voltage vs. Temperature  
 $V^+/V^-=\pm 15V$

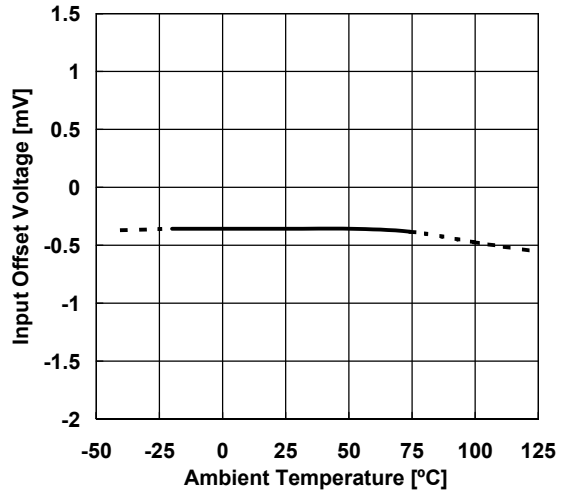

Input Bias Current vs. Temperature  
 $V^+/V^-=\pm 15V$

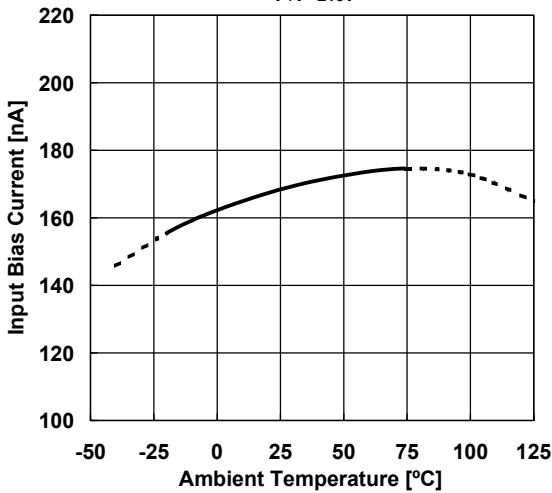

Maximum Output Voltage vs. Temperature  
 $V^+/V^-=\pm 15V, R_L=2k\Omega$

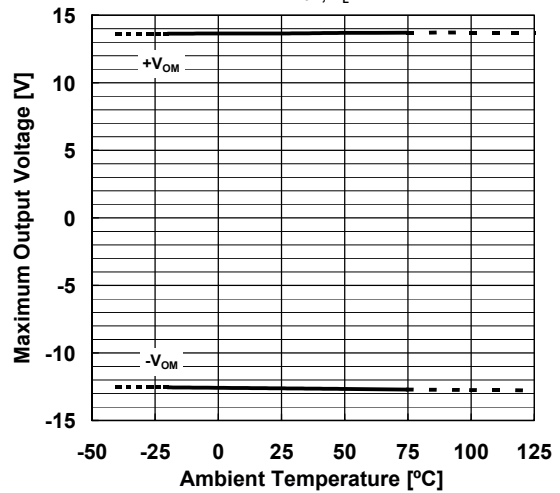

Maximum Output Voltage vs. Supply Voltage  
 $T_a=25^\circ C$

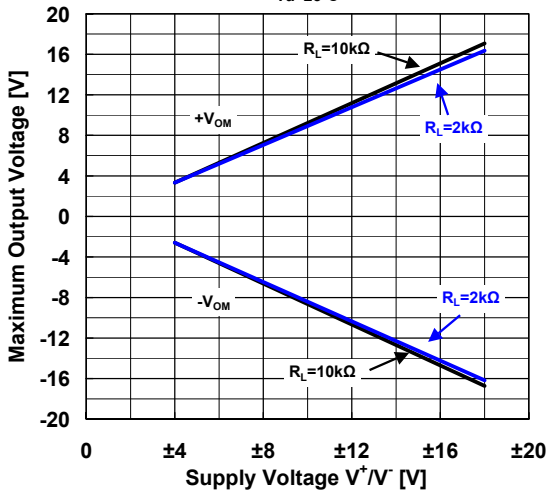

## ■ TEST CIRCUIT

Noise Voltage (RIAA) measurement circuit

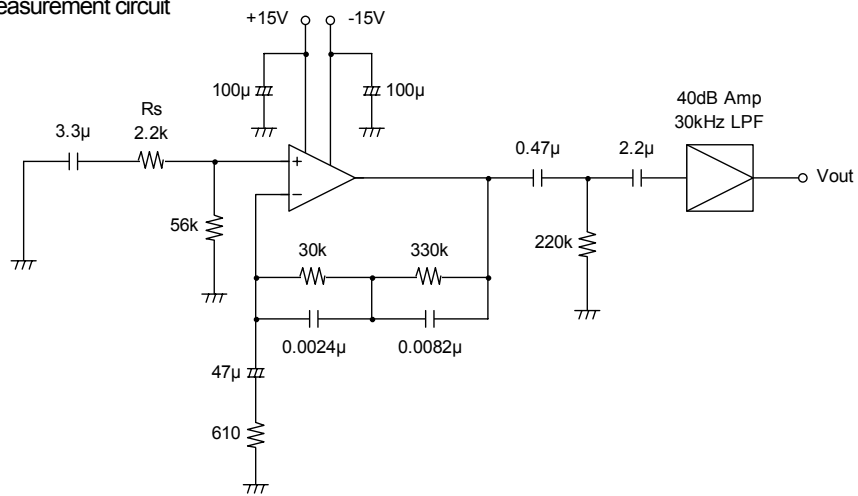

**[CAUTION]**

The specifications on this databook are only given for information, without any guarantee as regards either mistakes or omissions. The application circuits in this databook are described only to show representative usages of the product and not intended for the guarantee or permission of any right including the industrial rights.

## X-ON Electronics

Largest Supplier of Electrical and Electronic Components

*Click to view similar products for [Operational Amplifiers - Op Amps](#) category:*

*Click to view products by [JRC](#) manufacturer:*

Other Similar products are found below :

[LM358SNG](#) [430227FB](#) [AZV831KTR-G1](#) [LT1678IS8](#) [042225DB](#) [058184EB](#) [SC2902DG](#) [UPC822G2-A](#) [UPC258G2-A](#) [MIC918YC5-TR](#)  
[NCS5651MNTXG](#) [NCV33202DMR2G](#) [NJM324E](#) [NTE925](#) [5962-9080901MCA\\*](#) [AP4310AUMTR-AG1](#) [HA1630D02MMEL-E](#)  
[HA1630S01LPEL-E](#) [SCY33178DR2G](#) [NJU77806F3-TE1](#) [NCV5652MUTWG](#) [NCV20034DR2G](#) [LM2902EDR2G](#) [NTE778S](#) [NTE871](#)  
[NTE924](#) [NTE937](#) [MCP6V16UT-E/OT](#) [MCP6V17T-E/MS](#) [MCP6V19T-E/ST](#) [SCY6358ADR2G](#) [LTC2065IUD#PBF](#) [NCS20282FCTTAG](#)  
[UPC4741G2-E1-A](#) [LM4565FVT-GE2](#) [EL5420CRZ-T7A](#) [TSV791IYLT](#) [TSV772IQ2T](#) [AS324AMTR-E1](#) [TLV2772QPWR](#) [NJM4556AM-](#)  
[TE1](#) [NJM2068M-TE1](#) [AS324MTR-E1](#) [AS358MMTR-G1](#) [MCP6232T-EMNY](#) [MCP662-E/MF](#) [TLC081AIP](#) [TLC082AIP](#) [TLE2074ACDW](#)  
[TLV07IDR](#)