

DUAL OPERATIONAL AMPLIFIER

■ GENERAL DESCRIPTION

The NJM4565 is a high-gain, wide-bandwidth, dual low noise operational amplifier capable of driving 20V peak-to-peak into 400Ω loads. The NJM4565 is good characteristics compared to the NJM4560.

■ FEATURES

- Operating Voltage (±4V~±18V)
- Wide Gain Bandwidth Product (4MHz typ.)
- Slew Rate (4V/μs typ.)
- Package Outline DIP8, DMP8, SSOP8, SIP8
SOP8 JEDEC 150mil
- Bipolar Technology

■ PACKAGE OUTLINE

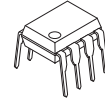

NJM4565D
(DIP8)



NJM4565M
(DMP8)



NJM4565E
(SOP8)



NJM4565V
(SSOP8)

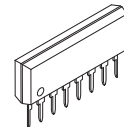

NJM4565L
(SIP8)

■ PIN CONFIGURATION

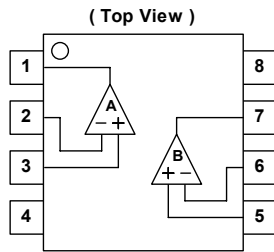

NJM4565D, NJM4565M, NJM4565E, NJM4565V

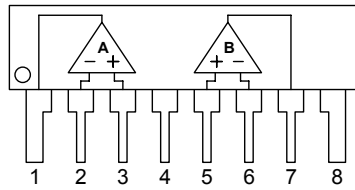

NJM4565L

PIN FUNCTION

1. A OUTPUT
2. A - INPUT
3. A +INPUT
4. V⁻
5. B +INPUT
6. B - INPUT
7. B OUTPUT

■ EQUIVALENT CIRCUIT (1/2 Shown)

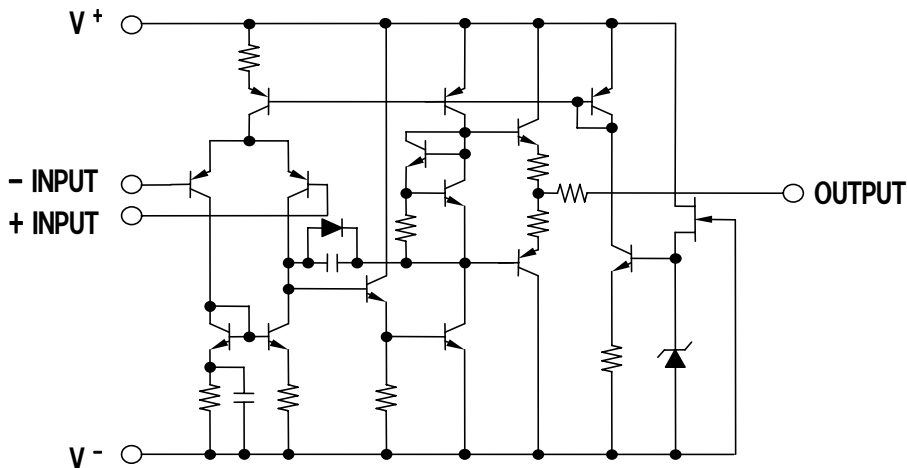

NJM4565

■ ABSOLUTE MAXIMUM RATINGS

(Ta=25°C)

PARAMETER	SYMBOL	RATINGS	UNIT
Supply Voltage	V^+ / V^-	± 18	V
Differential Input Voltage	V_{ID}	± 30	V
Input Voltage	V_{IC}	± 15 (note)	V
Power Dissipation	P_D	(DIP8) 500 (DMP8) 300 (SOP8) 300 (SSOP8) 250 (SIP8) 800	mW
Operating Temperature Range	T_{opr}	-40~+85	°C
Storage Temperature Range	T_{stg}	-40~+125	°C

(note) For supply voltage less than ±15V, the absolute maximum input voltage is equal to the supply voltage.

■ ELECTRICAL CHARACTERISTICS

(Ta=25°C, $V^+ / V^- = \pm 15V$)

PARAMETER	SYMBOL	TEST CONDITION	MIN.	TYP.	MAX.	UNIT
Input Offset Voltage	V_{IO}	$R_S \leq 10k\Omega$	-	0.5	3.0	mV
Input Offset Current	I_{IO}		-	2	50	nA
Input Bias Current	I_B		-	50	200	nA
Input Resistance	R_{IN}		0.3	5	-	MΩ
Large Signal Voltage Gain	A_V	$R_L \geq 2k\Omega, V_O = \pm 10V$	86	100	-	dB
Maximum Output Voltage Swing 1	V_{OM1}	$R_L \geq 2k\Omega$	± 12	± 14	-	V
Maximum Output Voltage Swing 2	V_{OM2}	$I_O = 25mA$	± 10	± 11.5	-	V
Input Common Mode Voltage Range	V_{ICM}		± 12	± 14	-	V
Common Mode Rejection Ratio	CMR	$R_S \leq 10k\Omega$	70	90	-	dB
Supply Voltage Rejection Ratio	SVR	$R_S \leq 10k\Omega$	76.5	90	-	dB
Operating Current	I_{CC}		-	4.5	7	mA
Slew Rate	SR		-	4	-	V/μs
Gain Bandwidth Product	GB		-	10	-	MHz
Equivalent Input Noise Voltage	V_{NI}	RIAA, $R_S = 2.2k\Omega$, 30kHz LPF	-	1.2	-	μVrms

■ TYPICAL CHARACTERISTICS

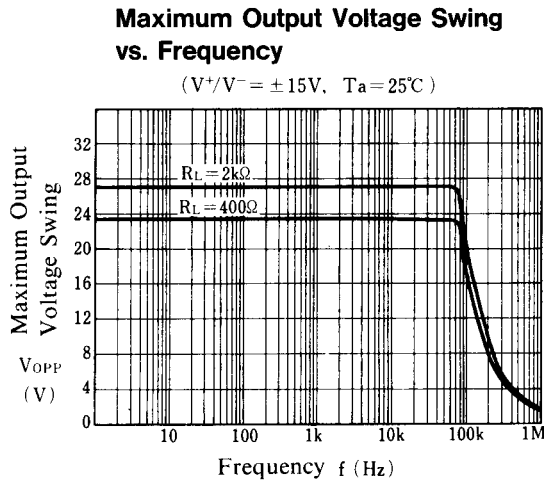

Equivalent Input Noise Voltage vs. Frequency

($V^+/V^- = \pm 15V$, $R_s = 1k\Omega$, $T_a = 25^\circ C$)

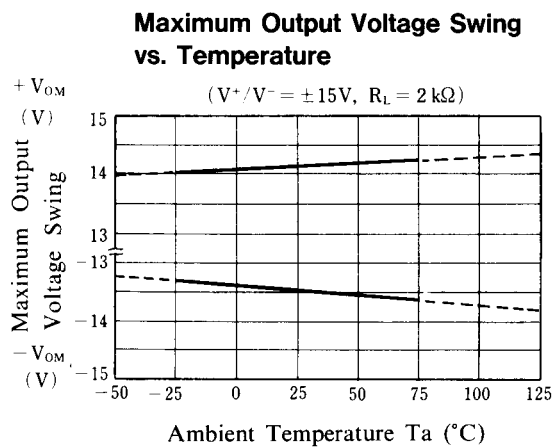
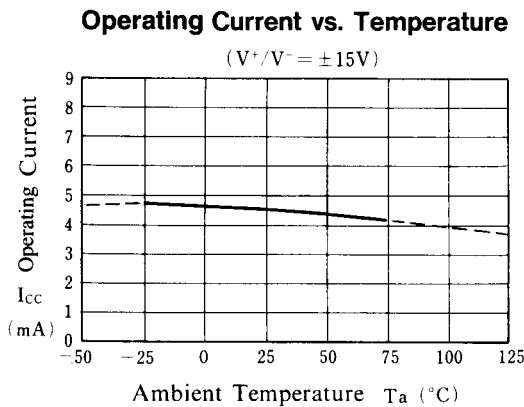
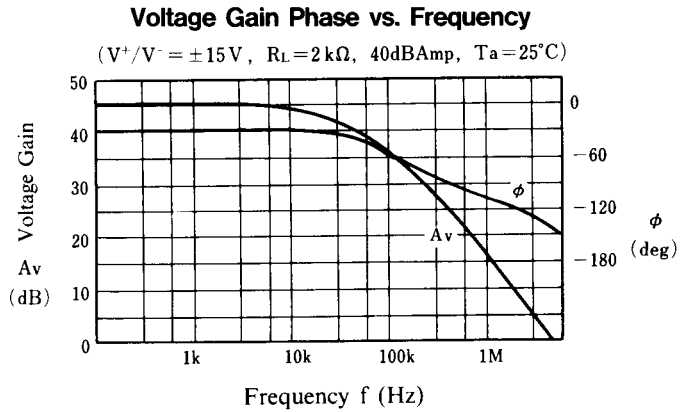
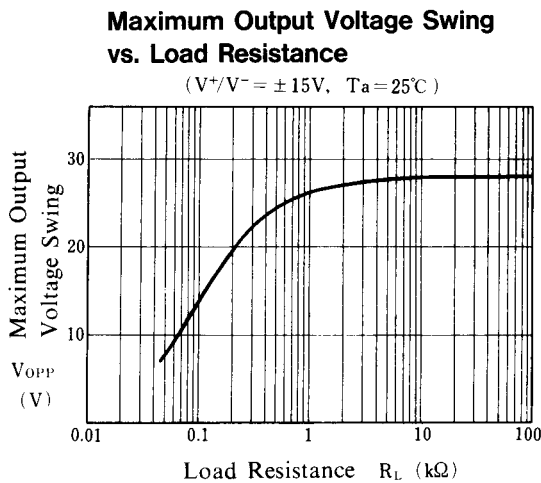
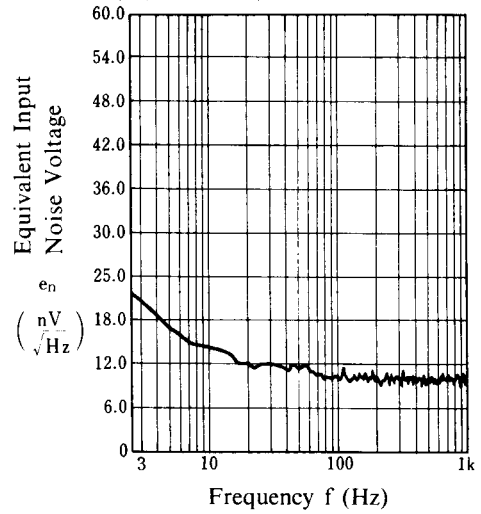

■ TYPICAL CHARACTERISTICS

Input Offset Voltage vs. Temperature

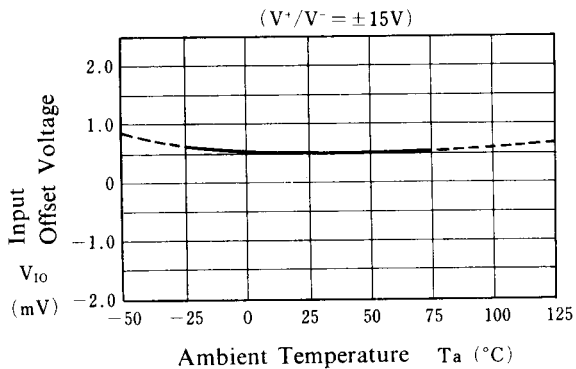

Input Bias Current vs. Temperature

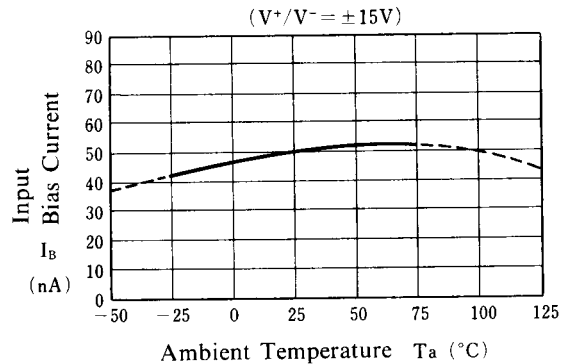

Maximum Output Voltage Swing vs. Operating Voltage

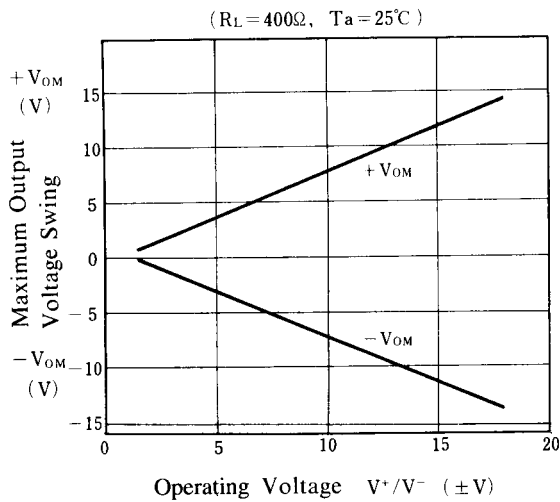

Operating Current vs. Operating Voltage

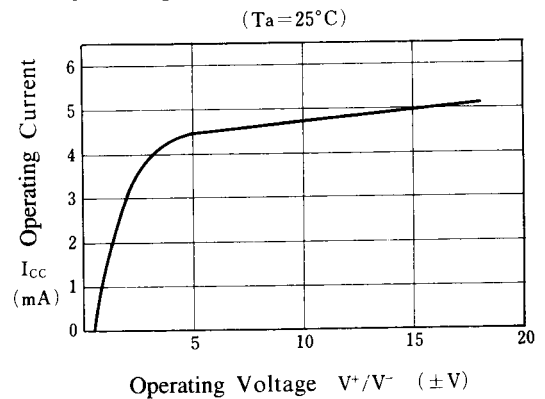

[CAUTION]
 The specifications on this databook are only given for information, without any guarantee as regards either mistakes or omissions. The application circuits in this databook are described only to show representative usages of the product and not intended for the guarantee or permission of any right including the industrial rights.

X-ON Electronics

Largest Supplier of Electrical and Electronic Components

Click to view similar products for [Operational Amplifiers - Op Amps](#) category:

Click to view products by [JRC](#) manufacturer:

Other Similar products are found below :

[430227FB](#) [AZV831KTR-G1](#) [UPC824G2-A](#) [LT1678IS8](#) [042225DB](#) [058184EB](#) [UPC822G2-A](#) [UPC258G2-A](#) [NCS5651MNTXG](#)
[NCV33202DMR2G](#) [NJM324E](#) [NTE925](#) [5962-9080901MCA*](#) [AP4310AUMTR-AG1](#) [HA1630D02MMEL-E](#) [HA1630S01LPEL-E](#)
[SCY33178DR2G](#) [NJU77806F3-TE1](#) [NCV5652MUTWG](#) [NCV20034DR2G](#) [LM2902EDR2G](#) [NTE778S](#) [NTE871](#) [NTE924](#) [NTE937](#)
[MCP6V16UT-E/OT](#) [MCP6V17T-E/MS](#) [MCP6V19T-E/ST](#) [SCY6358ADR2G](#) [LTC2065IUD#PBF](#) [NCS20282FCTTAG](#) [UPC4741G2-E1-A](#)
[LM4565FVT-GE2](#) [EL5420CRZ-T7A](#) [TSV791IYLT](#) [TSV772IQ2T](#) [AS324AMTR-E1](#) [TLV2772QPWR](#) [NJM4556AM-TE1](#) [NJM2068M-TE1](#)
[AS324MTR-E1](#) [AS358MMTR-G1](#) [MCP6232T-EMNY](#) [MCP662-E/MF](#) [TLC081AIP](#) [TLC082AIP](#) [TLE2074ACDW](#) [TLV07IDR](#)
[TLV2170IDGKT](#) [TLV2455IDR](#)