

DUAL OPERATIONAL AMPLIFIER

■ GENERAL DESCRIPTION

The NJM4580 is a dual operational amplifier, specially designed for improving the tone control, which is most suitable for the audio application.

Featuring noiseless, higher gain bandwidth, high output current and low distortion ratio, and it is most suitable not only for acoustic electronic parts of audio pre-amp and active filter, but also for the industrial measurement tools. It is also suitable for the head phone amp at higher output current, and further more, it can be applied for the handy type set operational amplifier of general purpose in application of low voltage single supply type which is properly biased of the low voltage source.

The D-Rank type products(NJM4580DD/LD/MD/ED) have specified maximum limits for equivalent input noise voltage.

■ PACKAGE OUTLINE

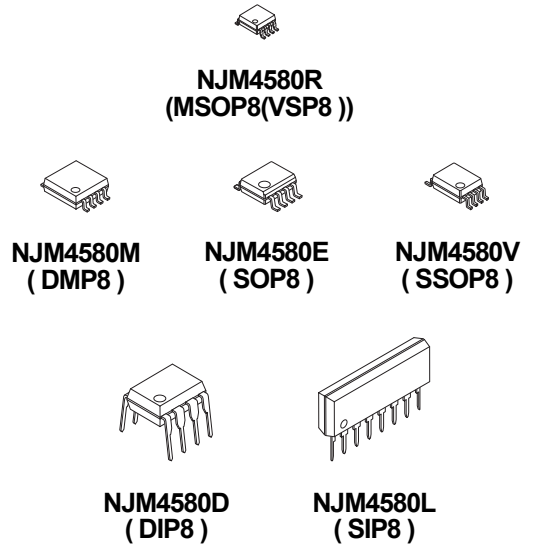

■ FEATURES

- Operating Voltage $\pm 2V \sim \pm 18V$
- Low Input Noise Voltage $0.8\mu V_{rms}$ typ. (RIAA)
- Wide GBW $15MHz$ typ.
- Low Distortion 0.0005% typ.
- Slew Rate $5V/\mu s$ typ.
- Bipolar Technology
- Package Outline

DIP8, SIP8, DMP8, SSOP8, MSOP8(VSP8) MEET JEDEC MO-187-DA
SOP8 JEDEC 150mil

■ PIN CONFIGURATION

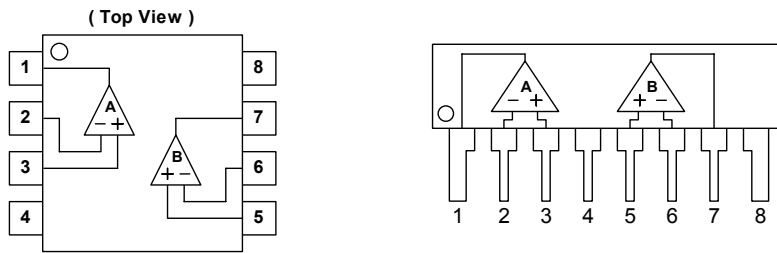

NJM4580D, NJM4580M, NJM4580E
NJM4580V, NJM4580R

NJM4580L

PIN FUNCTION

1. A OUTPUT
2. A - INPUT
3. A + INPUT
4. V^-
5. B + INPUT
6. B - INPUT
7. B OUTPUT
8. V^+

■ EQUIVALENT CIRCUIT (1/2 Shown)

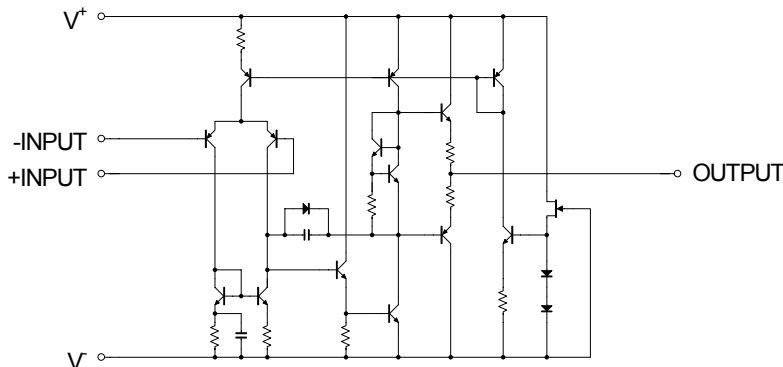

NJM4580

■ ABSOLUTE MAXIMUM RATINGS

(Ta=25°C, unless otherwise noted.)

PARAMETER	SYMBOL	RATING	UNIT
Supply Voltage	V ⁺ /V	±18	V
Input Voltage	V _{ICM}	±15 (Note1)	V
Differential Input Voltage	V _{ID}	±30 (Note1)	V
Power Dissipation	P _D	DIP8, SIP8 : 800 DMP8, SOP8 : 300 SSOP8 : 250 MSOP8(VSP8) : 400 (Note2)	mW
Operating Temperature Range	Topr	-40~+85	°C
Storage Temperature Range	Tstg	-40~+125	°C

(Note1) For supply voltage less than ±15V, the absolute maximum input voltage is equal to supply voltage.

(Note2) On the PCB "EIA/JEDEC (114.3×76.2×1.57mm, 2 layers, FR-4)"

■ RECOMMENDED OPERATING CONDITIONS

(Ta=25°C)

PARAMETER	SYMBOL	CONDITION	MIN.	TYP.	MAX.	UNIT
Supply Voltage	V ⁺ /V		±2	-	±18	V

■ ELECTRICAL CHARACTERISTICS

(V⁺/V=±15V, Ta=25°C, unless otherwise noted.)

PARAMETER	SYMBOL	TEST CONDITION	MIN.	TYP.	MAX.	UNIT
Input Offset Voltage	V _{IO}	R _S ≤10kΩ	-	0.3	3	mV
Input Offset Current	I _{IO}		-	5	200	nA
Input Bias Current	I _B		-	100	500	nA
Voltage Gain	A _V	R _L ≥2kΩ, V _O =±10V	90	110	-	dB
Maximum Output Voltage	V _{OM}	R _L ≥2kΩ	±12	±13.5	-	V
Common Mode Input Voltage Range	V _{ICM}		±12	±13.5	-	V
Common Mode Rejection Ratio	CMR	R _S ≤10kΩ	80	110	-	dB
Supply Voltage Rejection Ratio	SVR	R _S ≤10kΩ	80	110	-	dB
Supply Current	I _{CC}		-	6	9	mA
Slew Rate	SR	R _L ≥2kΩ	-	5	-	V/μs
Gain Bandwidth Product	GB	f=10kHz	-	15	-	MHz
Total Harmonic Distortion	THD	A _V =20dB, V _O =5V, R _L =2kΩ, f=1kHz	-	0.0005	-	%
Equivalent Input Noise Voltage	V _{NI}	RIAA, R _S =2.2kΩ, 30kHz LPF	-	0.8	-	μVrms

■ ELECTRICAL CHARACTERISTICS

(D-rank type(Note3), V⁺/V=±15V, Ta=25°C, unless otherwise noted.)

PARAMETER	SYMBOL	TEST CONDITION	MIN.	TYP.	MAX.	UNIT
Equivalent Input Noise Voltage	V _{NI}	RIAA, R _S =2.2kΩ	-	-	1.4	μVrms

(Note3) D-rank type is a Equivalent Input Noise Voltage selected product. It s only DIP, DMP, SOP and SIP package.

■ TYPICAL CHARACTERISTICS

40dB Gain/Phase vs. Frequency
 $V^+/V^-=\pm 15V, R_L=2k\Omega, T_a=25^\circ C$

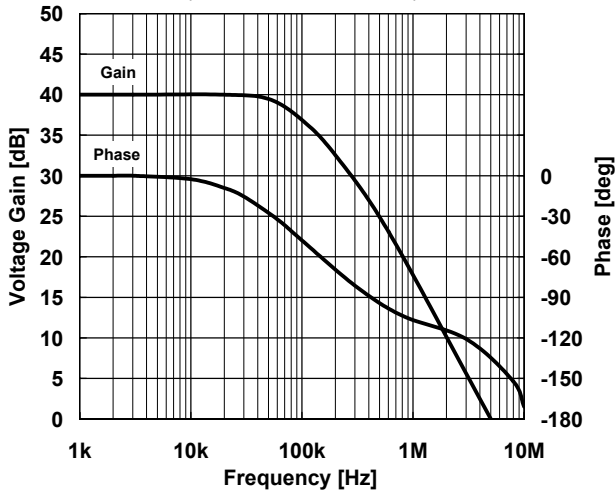

Maximum Output Voltage vs. Frequency
 $V^+/V^-=\pm 15V, R_L=2k\Omega, T_a=25^\circ C$

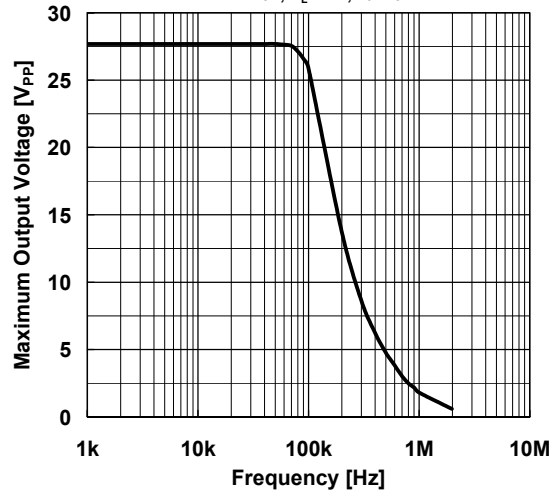

Maximum Output Voltage vs. Output Current
 $V^+/V^-=\pm 15V, T_a=25^\circ C$

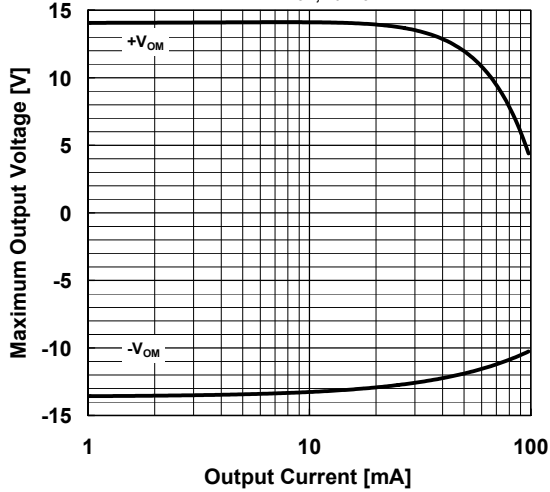

Maximum Output Voltage vs. Load Resistance
 $V^+/V^-=\pm 15V, T_a=25^\circ C$

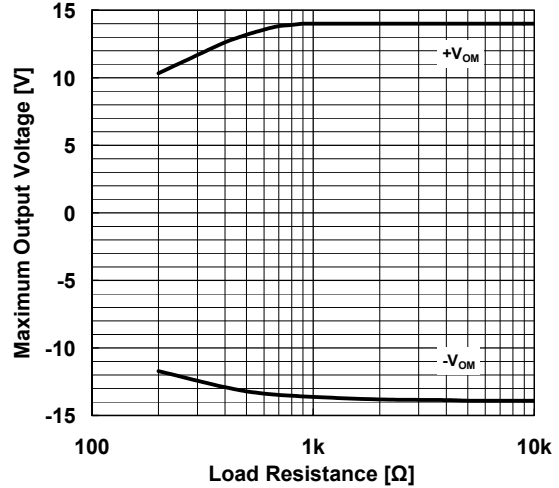

THD+N vs. Output Voltage (Frequency)
 $V^+/V^-=\pm 15V, G_v=20dB, R_L=2k\Omega$

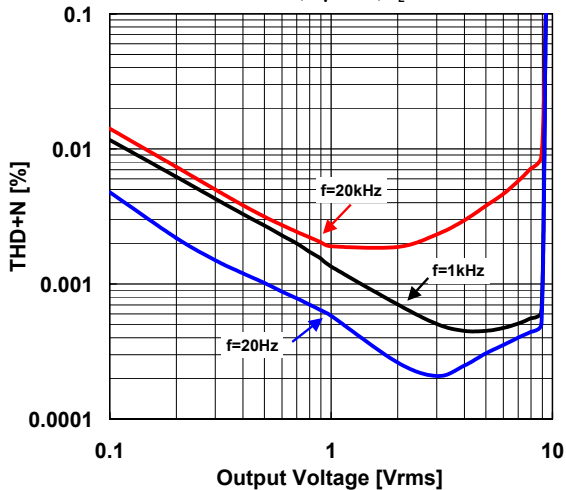

Voltage Noise vs. Frequency
 $V^+/V^-=\pm 15V, R_s=50\Omega, G_v=60dB, T_a=25^\circ C$

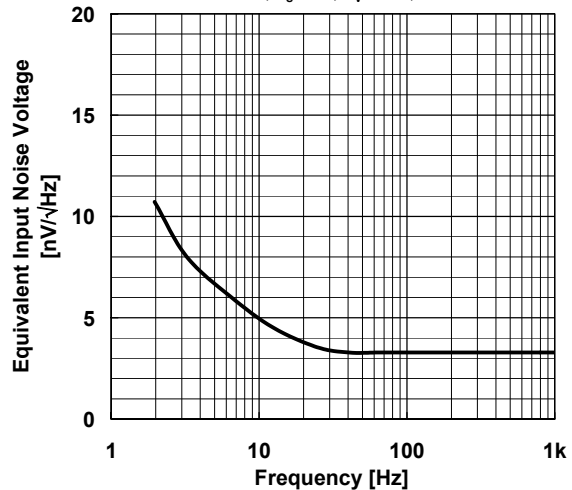

■ TYPICAL CHARACTERISTICS

Supply Current vs. Supply Voltage

$T_a=25^\circ\text{C}$

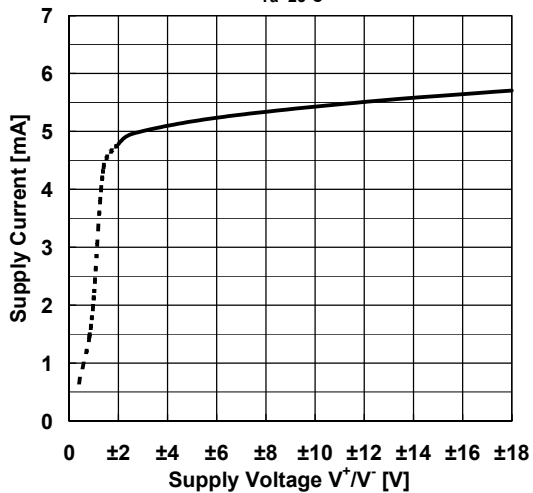

Supply Current vs. Temperature

$V^+/V^-=\pm 15\text{V}$

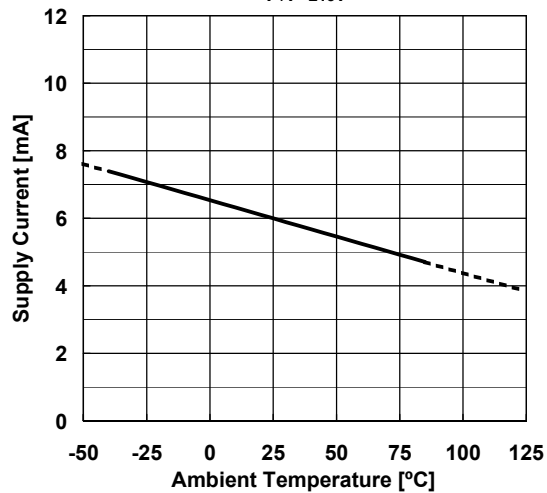

Input Offset Voltage vs. Temperature

$V^+/V^-=\pm 15\text{V}$

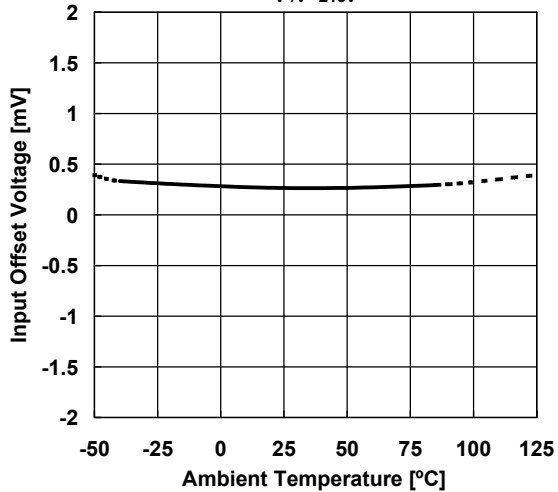

Input Bias Current vs. Temperature

$V^+/V^-=\pm 15\text{V}$

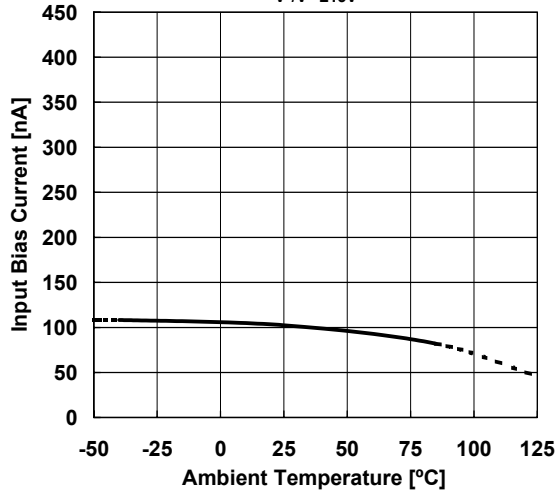

Maximum Output Voltage vs. Supply Voltage

$R_L=2\text{k}\Omega, T_a=25^\circ\text{C}$

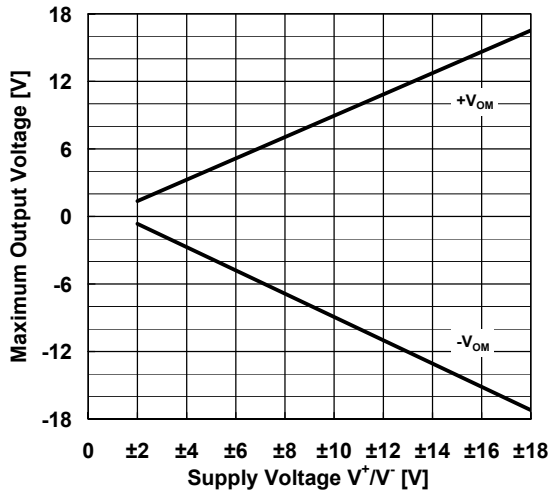

Maximum Output Voltage vs. Temperature

$V^+/V^-=\pm 15\text{V}, R_L=2\text{k}\Omega$

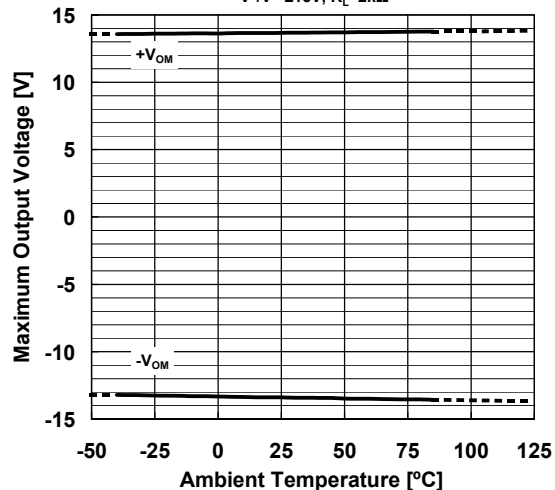

■ TEST CIRCUIT

Noise Voltage (RIAA) measurement circuit

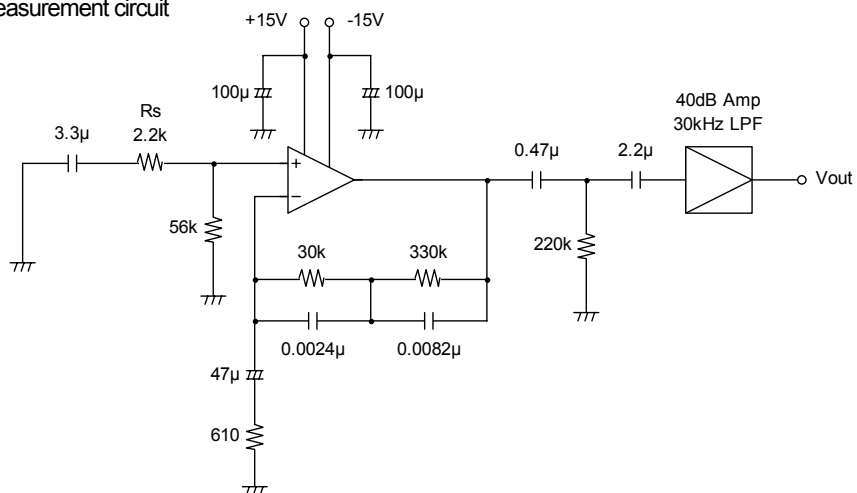

[CAUTION]

The specifications on this databook are only given for information, without any guarantee as regards either mistakes or omissions. The application circuits in this databook are described only to show representative usages of the product and not intended for the guarantee or permission of any right including the industrial rights.

X-ON Electronics

Largest Supplier of Electrical and Electronic Components

Click to view similar products for [Operational Amplifiers - Op Amps](#) category:

Click to view products by [JRC](#) manufacturer:

Other Similar products are found below :

[430227FB](#) [LT1678IS8](#) [NCV33202DMR2G](#) [NJM324E](#) [M38510/13101BPA](#) [NTE925](#) [AZV358MTR-G1](#) [AP4310AUMTR-AG1](#)
[AZV358MMTR-G1](#) [SCY33178DR2G](#) [NCV20034DR2G](#) [NTE778S](#) [NTE871](#) [NTE937](#) [NJU7057RB1-TE2](#) [SCY6358ADR2G](#)
[NJM2904CRB1-TE1](#) [UPC4570G2-E1-A](#) [UPC4741G2-E1-A](#) [NJM8532RB1-TE1](#) [EL2250CS](#) [EL5100IS](#) [EL5104IS](#) [EL5127CY](#) [EL5127CZY](#)
[EL5133IW](#) [EL5152IS](#) [EL5156IS](#) [EL5162IS](#) [EL5202IY](#) [EL5203IY](#) [EL5204IY](#) [EL5210CS](#) [EL5210CZY](#) [EL5211IYE](#) [EL5220CY](#)
[EL5223CLZ](#) [EL5223CR](#) [EL5224ILZ](#) [EL5227CLZ](#) [EL5227CRZ](#) [EL5244CS](#) [EL5246CS](#) [EL5246CSZ](#) [EL5250IY](#) [EL5251IS](#) [EL5257IS](#)
[EL5260IY](#) [EL5261IS](#) [EL5300IU](#)