

## LOW-NOISE DUAL OPERATIONAL AMPLIFIER

### ■ GENERAL DESCRIPTION

The NJM5532 is a high performance dual low noise operational amplifier. Compared to the standard dual operational amplifiers, such as the NJM4558, it shows better noise performance, improved output drive capability, and considerably higher small-signal and power bandwidths. It is compensated internally for voltage follower circuit. This makes the device especially suitable for application in high quality and professional audio equipment, instrumentation, control circuits, and telephone channel amplifiers.

If very low noise characteristic is of prime importance, it is recommended D-Rank type products (NJM5532DD/LD/MD). These have specified maximum limits for equivalent input noise voltage.

### ■ PACKAGE OUTLINE

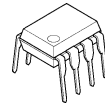

NJM5532D  
(DIP8)

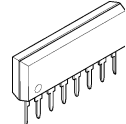

NJM5532L  
(SIP8)



NJM5532M  
(DMP8)

### ■ FEATURES

- Operating Voltage                     $\pm 3V \sim \pm 22V$
- Small Signal Bandwidth            10MHz typ.
- Output Drive Capability            600 $\Omega$ , 10Vrms typ.
- Input Noise Voltage                5nV/ $\sqrt{\text{Hz}}$  typ.
- Power Bandwidth                    140kHz typ.
- Slew Rate                              8V/ $\mu\text{s}$  typ.
- Bipolar Technology
- Package Outline                     DIP8, DMP8, SIP8

### ■ PIN CONFIGURATION

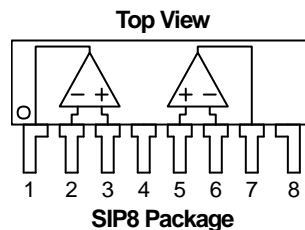
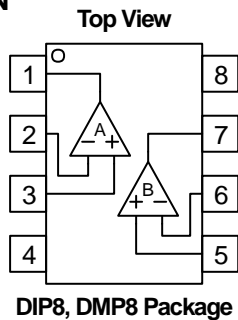

#### PIN FUNCTION

- 1.A OUTPUT
- 2.A -INPUT
- 3.A +INPUT
- 4.V<sup>-</sup>
- 5.B +INPUT
- 6.B -INPUT
- 7.B OUTPUT
- 8.V<sup>+</sup>

### ■ EQUIVALENT CIRCUIT ( 1/2 Shown )

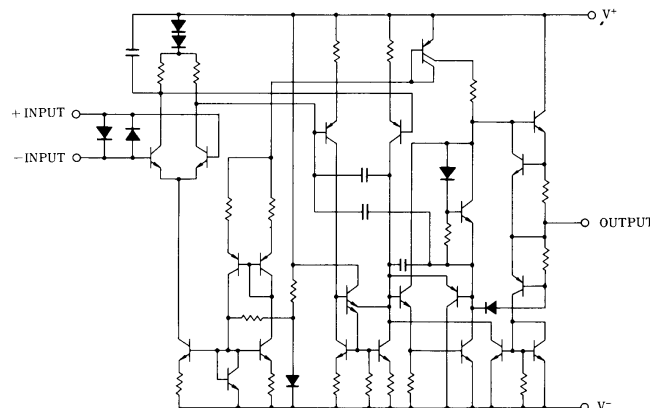

# NJM5532

## ■ ABSOLUTE MAXIMUM RATINGS (Ta=25°C)

PARAMETER	SYMBOL	RATING	UNIT
Supply Voltage	V <sup>+</sup> /V	±22	V
Common Mode Input Voltage Range	V <sub>ICM</sub>	V <sup>+</sup> /V	V
Differential Input Voltage Range	V <sub>ID</sub>	±0.5	V
Power Dissipation	P <sub>D</sub>	DIP8 : 500 DMP8 : 600(Note1) SIP8 : 800	mW
Operating Temperature Range	T <sub>opr</sub>	-20~+75	°C
Storage Temperature Range	T <sub>stg</sub>	-40~+125	°C

(Note1) On the cermic PCB (10x20x0.635mm)

## ■ RECOMMENDED OPERATING VOLTAGE (Ta=25°C)

PARAMETER	SYMBOL	RATING	UNIT
Supply Voltage	V <sup>+</sup> /V	±3~±22	V

## ■ ELECTRICAL CHARACTERISTICS (V<sup>+</sup>/V=±15V, Ta=25°C, unless otherwise noted.)

### ● DC ELECTRICAL CHARACTERISTICS

PARAMETER	SYMBOL	TEST CONDITION	MIN.	TYP.	MAX.	UNIT
Input Offset Voltage	V <sub>IO</sub>	R <sub>S</sub> ≤10kΩ	-	0.5	4	mV
Input Offset Current	I <sub>IO</sub>		-	10	150	nA
Input Bias Current	I <sub>B</sub>		-	200	800	nA
Supply Current	I <sub>CC</sub>	R <sub>L</sub> =∞	-	9	16	mA
Common Mode Input Voltage Range	V <sub>ICM</sub>		±12	±13	-	V
Common Mode Rejection Ratio	CMR	R <sub>S</sub> ≤10kΩ	70	100	-	dB
Supply Voltage Rejection Ratio	SVR	R <sub>S</sub> ≤10kΩ	80	100	-	dB
Voltage Gain1	A <sub>V1</sub>	R <sub>L</sub> ≥2kΩ, V <sub>O</sub> =±10V	88	100	-	dB
Voltage Gain2	A <sub>V2</sub>	R <sub>L</sub> ≥600Ω, V <sub>O</sub> =±10V	83.5	94	-	dB
Maximum Output Voltage1	V <sub>OM1</sub>	R <sub>L</sub> ≥600Ω	±12	±13	-	V
Maximum Output Voltage2	V <sub>OM2</sub>	R <sub>L</sub> ≥600Ω, V <sup>+</sup> /V=±18V	±15	±16	-	V
Input Resistance	R <sub>IN</sub>		30	300	-	kΩ
Short Circuit Output Current	I <sub>OS</sub>		-	38	-	mA

### ● AC ELECTRICAL CHARACTERISTICS

PARAMETER	SYMBOL	TEST CONDITION	MIN.	TYP.	MAX.	UNIT
Output Resistance	R <sub>O</sub>	A <sub>V</sub> =30dB, f=10kHz, R <sub>L</sub> =600Ω	-	0.3	-	Ω
Overshoot		A <sub>V</sub> =1, V <sub>IN</sub> =100mV <sub>PP</sub> , R <sub>L</sub> =100pF, R <sub>L</sub> =600Ω	-	10	-	%
Voltage Gain	A <sub>V</sub>	f=10kHz	-	67	-	dB
Slew Rate	SR		-	8	-	V/μs
Gain Bandwidth Product	GB	C <sub>L</sub> =100pF, R <sub>L</sub> =600Ω	-	10	-	MHz
Power Bandwidth	W <sub>PG</sub>	V <sub>O</sub> =±10V	-	140	-	kHz
	W <sub>PG</sub>	V <sub>O</sub> =±14V, R <sub>L</sub> =600Ω, V <sup>+</sup> /V=±18V	-	100	-	kHz
Equivalent Input Noise Voltage	e <sub>n</sub>	f <sub>O</sub> =30Hz	-	8	-	nV/√Hz
	e <sub>n</sub>	f <sub>O</sub> =1kHz	-	5	-	nV/√Hz
Equivalent Input Noise Current	i <sub>n</sub>	f <sub>O</sub> =30Hz	-	2.7	-	pA/√Hz
	i <sub>n</sub>	f <sub>O</sub> =1kHz	-	0.7	-	pA/√Hz
Channel Separation	CS	f=1kHz, R <sub>S</sub> =5kΩ	-	110	-	dB

## ■ ELECTRICAL CHARACTERISTICS (D-ranktype(Note2), V<sup>+</sup>/V=±15V, Ta=25°C, unless otherwise noted.)

PARAMETER	SYMBOL	TEST CONDITION	MIN.	TYP.	MAX.	UNIT
Equivalent Input Noise Voltage	V <sub>NI</sub>	RIAA, R <sub>S</sub> =2.2kΩ	-	-	1.4	μVrms

(Note2) D-rank type is a Equivalent Input Noise Voltage selected product.

## ■ TYPICAL CHARACTERISTICS

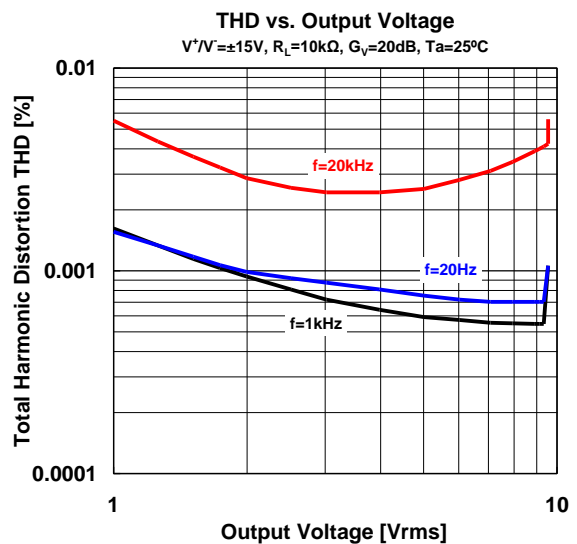
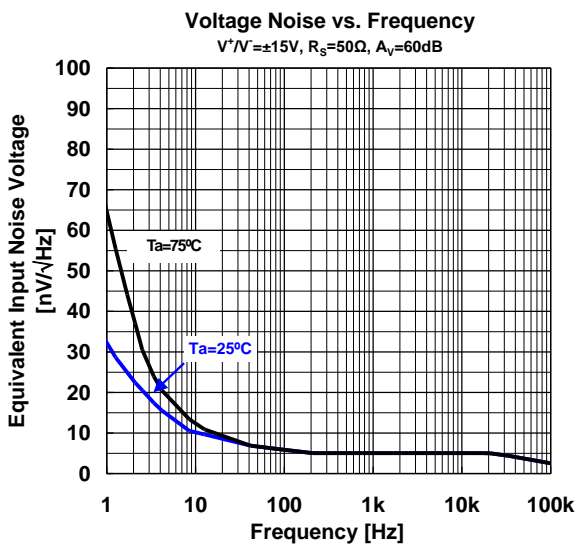
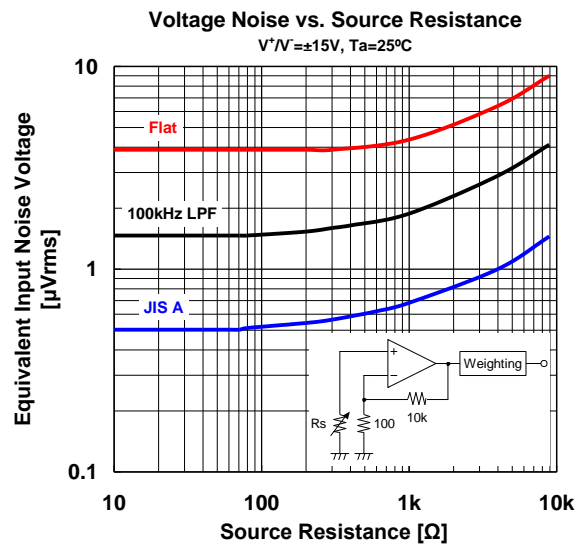
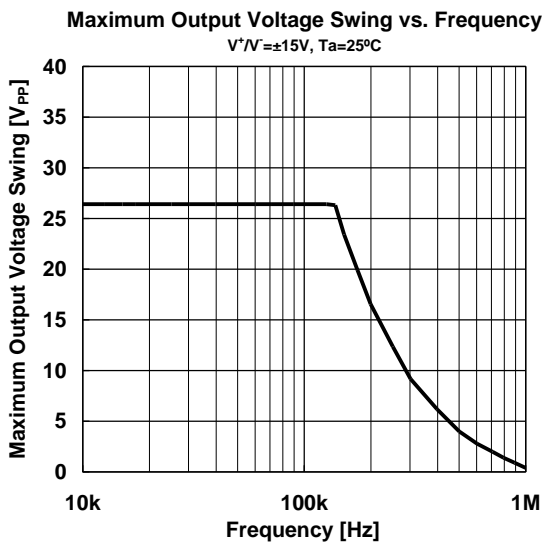
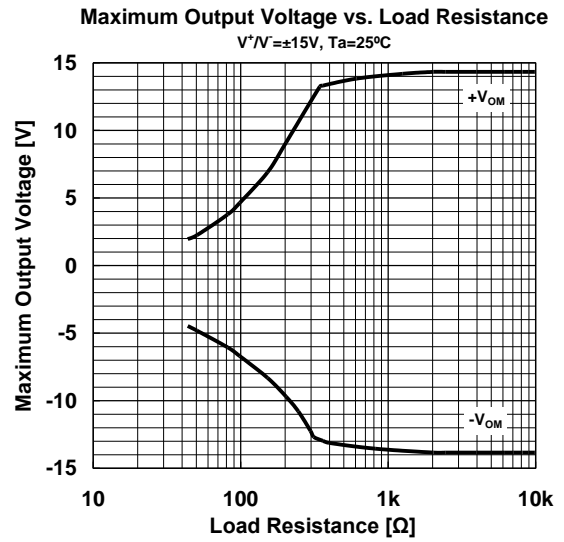
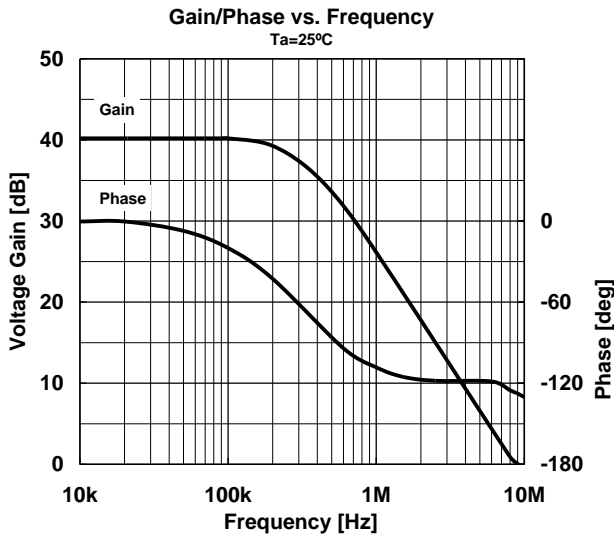

## ■ TYPICAL CHARACTERISTICS

Supply Current vs. Supply Voltage  
Ta=25°C

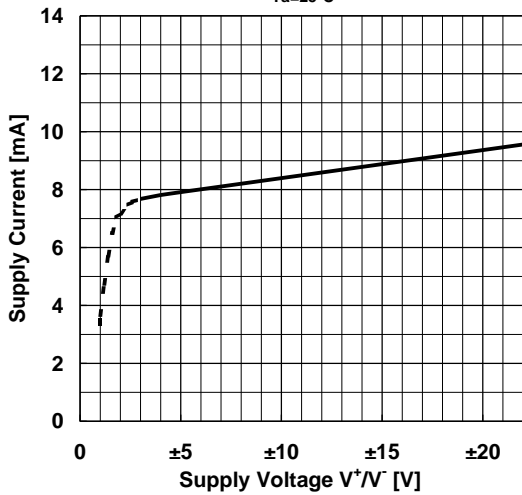

Supply Current vs. Temperature  
V+/V- = ±15V

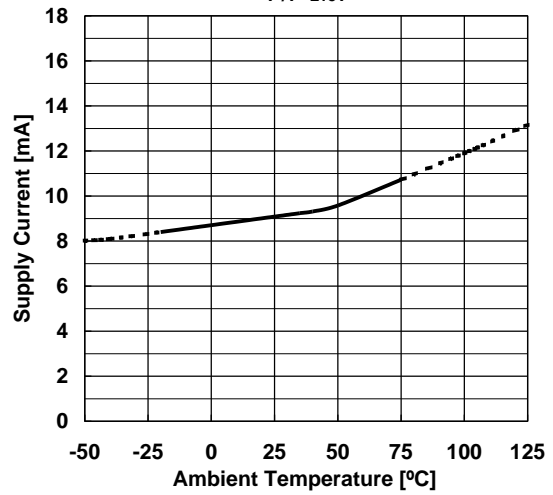

Input Offset Voltage vs. Temperature  
V+/V- = ±15V

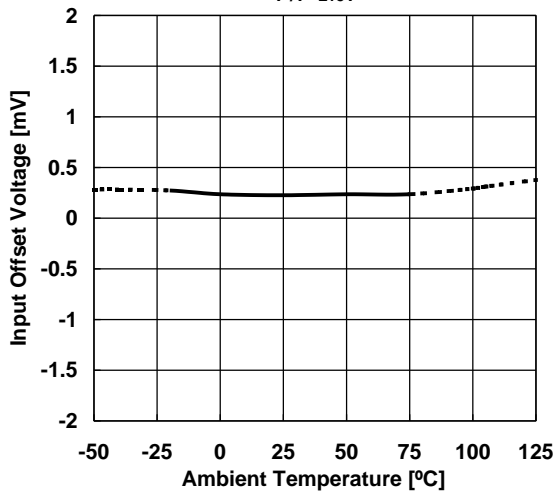

Input Bias Current vs. Temperature  
V+/V- = ±15V

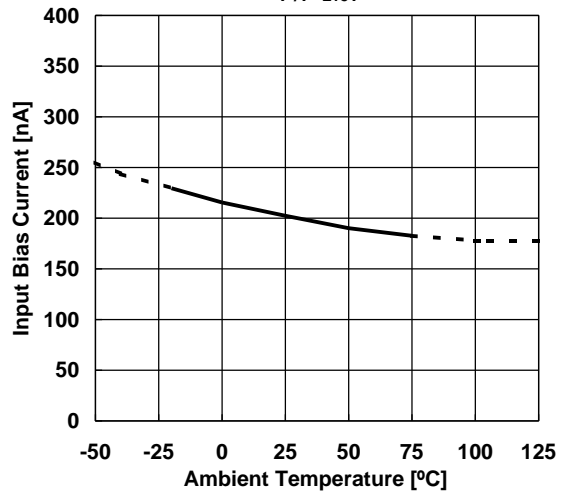

Maximum Output Voltage vs. Supply Voltage  
R<sub>L</sub>=2kΩ, Ta=25°C

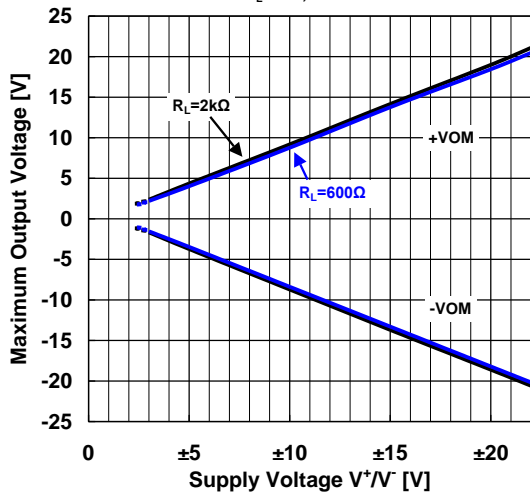

Maximum Output Voltage vs. Temperature  
V+/V- = ±15V, R<sub>L</sub>=600Ω

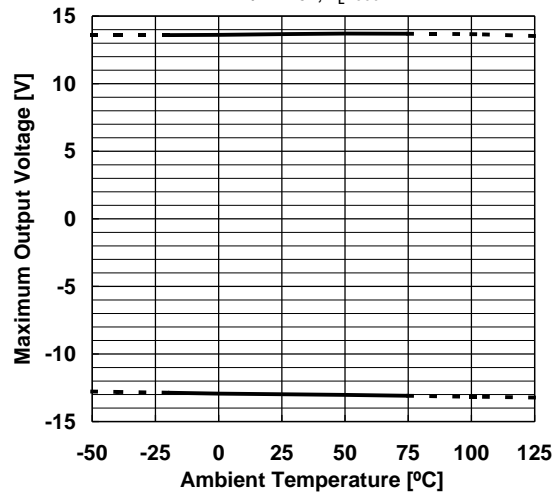

## ■ TEST CIRCUIT

Noise Voltage (RIAA) measurement circuit

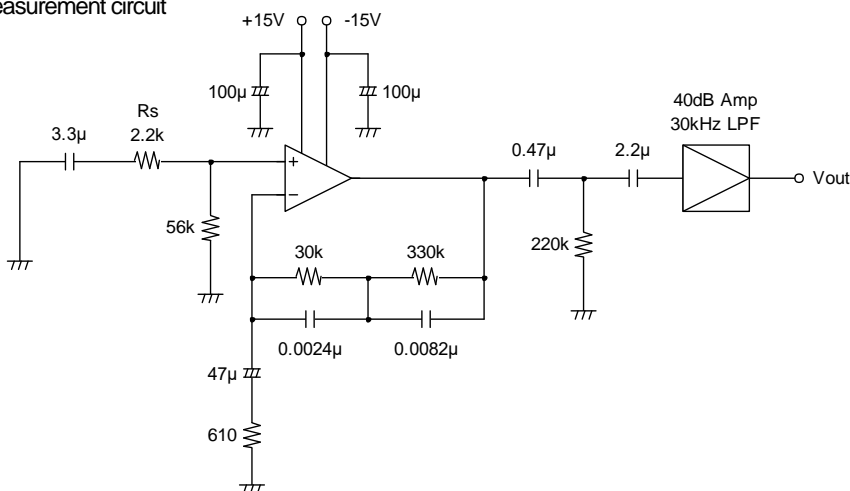

## ■ NOTICE

When used in voltage follower circuit, put a current limit resistor into non-inverting input terminal in order to avoid inside input diode destruction when the power supply is turned on. ( ref.Fig.1 )

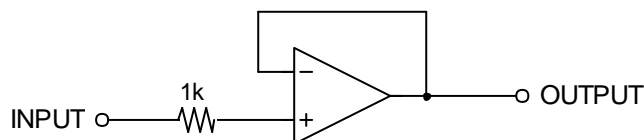

(Fig.1)

## ■ Caution to Thermal Design

If the NJM5532 junction temperature ( $T_j$ ) exceeds guaranteed value (125 degree) or the package power dissipation ( $P_D$ ), there is possibility of the NJM5532 deterioration or breakdown.

The NJM5532 supply current is higher ( $I_{CCMAX}=16mA$  at  $V^+ / V^- = \pm 15V, T_a = +25^\circ C$ ) and has positive temperature coefficient (Refer to Supply Current vs. Temperature characteristic).

Therefore, you should carefully design with due attention to the supply voltage, the internal power dissipation and the ambient temperature.

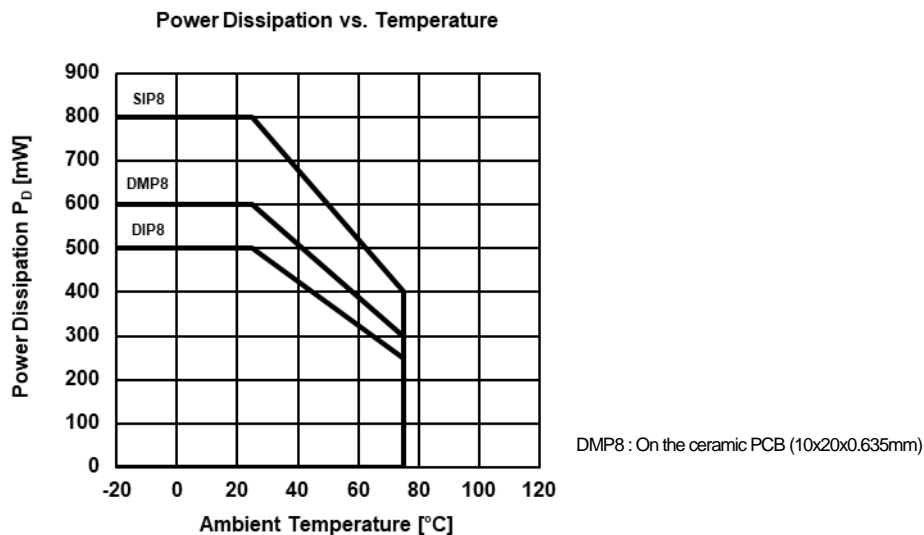

# NJM5532

## ■ Countermeasure to Excess Current by Parasitic Circuit

When the NJM5532  $V^+$  is open (Fig.2), the NJM5532 may be burnt flowing the excess current by internal parasitic circuit(Fig.3).The excess current generating condition is following:

- / Between input terminal and  $V^-$  voltage difference is higher.
- / Input terminal has no resistance of  $1k\Omega$  or more.
- /  $V^+$  terminal is connected with low impedance. (Ietc is higher)

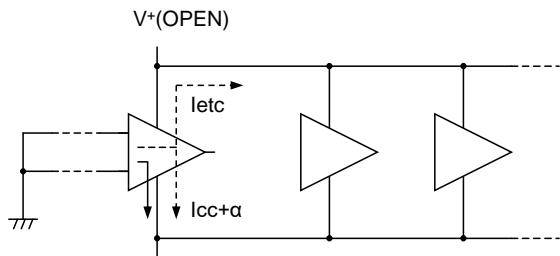

Fig.2

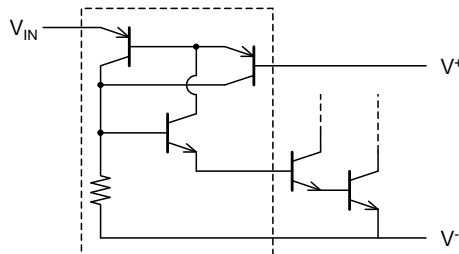

Fig.3

For countermeasure to excess current by parasitic circuit, NJRC recommends the following method.

- / prevent operating of a parasitic circuit by inserting a SBD (Fig.4-1/4-2).
- / limiting a parasitic circuit operation by inserting a resistance ( $1k\Omega$  or more) (Fig.5).

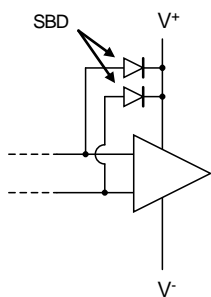

Fig.4-1

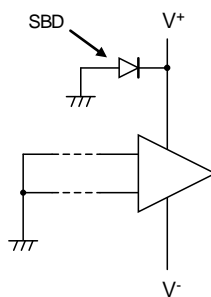

Fig.4-2

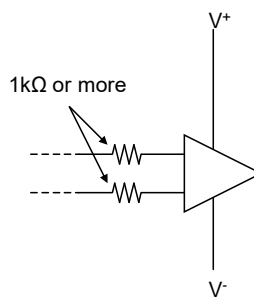

Fig.5

[CAUTION]  
The specifications on this databook are only given for information, without any guarantee as regards either mistakes or omissions. The application circuits in this databook are described only to show representative usages of the product and not intended for the guarantee or permission of any right including the industrial rights.

## X-ON Electronics

Largest Supplier of Electrical and Electronic Components

*Click to view similar products for [Operational Amplifiers - Op Amps](#) category:*

*Click to view products by [JRC](#) manufacturer:*

Other Similar products are found below :

[430227FB](#) [AZV831KTR-G1](#) [UPC451G2-A](#) [UPC824G2-A](#) [LT1678IS8](#) [042225DB](#) [058184EB](#) [UPC822G2-A](#) [UPC258G2-A](#)  
[NCS5651MNTXG](#) [NCV33202DMR2G](#) [NJM324E](#) [NTE925](#) [5962-9080901MCA\\*](#) [AP4310AUMTR-AG1](#) [HA1630D02MMEL-E](#)  
[HA1630S01LPEL-E](#) [SCY33178DR2G](#) [NJU77806F3-TE1](#) [NCV5652MUTWG](#) [NCV20034DR2G](#) [LM2902EDR2G](#) [NTE778S](#) [NTE871](#)  
[NTE924](#) [NTE937](#) [MCP6V16UT-E/OT](#) [MCP6V17T-E/MS](#) [MCP6V19T-E/ST](#) [SCY6358ADR2G](#) [LTC2065IUD#PBF](#) [NCS20282FCTTAG](#)  
[LM4565FVT-GE2](#) [EL5420CRZ-T7A](#) [TSV791IYLT](#) [TSV772IQ2T](#) [TLV2772QPWR](#) [NJM2100M-TE1](#) [NJM4556AM-TE1](#) [MCP6487-E/SN](#)  
[MCP6487-E/MS](#) [AS324MTR-E1](#) [AS358MMTR-G1](#) [MCP6232T-EMNY](#) [MCP662-E/MF](#) [TLC081AIP](#) [TLC082AIP](#) [TLE2074ACDW](#)  
[TLV07IDR](#) [TLV2170IDGKT](#)