

LOW-NOISE DUAL OPERATIONAL AMPLIFIER

■ GENERAL DESCRIPTION

The NJM5532 is a high performance dual low noise operational amplifier. Compared to the standard dual operational amplifiers, such as the NJM1458, it shows better noise performance, improved output drive capability, and considerably higher small-signal and power bandwidths. It is compensated internally for voltage follower circuit. This makes the device especially suitable for application in high quality and professional audio equipment, instrumentation, control circuits, and telephone channel amplifiers.

If very low noise characteristic is of prime importance, it is recommended D-Rank type products (NJM5532DD/LD/MD). These have specified maximum limits for equivalent input noise voltage.

■ PACKAGE OUTLINE

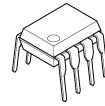

NJM5532D
(DIP8)

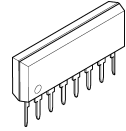

NJM5532L
(SIP8)



NJM5532M
(DMP8)

■ FEATURES

- Operating Voltage $\pm 3V \sim \pm 22V$
- Small Signal Bandwidth 10MHz typ.
- Output Drive Capability 600 Ω , 10Vrms typ.
- Input Noise Voltage 5nV/ $\sqrt{\text{Hz}}$ typ.
- Power Bandwidth 140kHz typ.
- Slew Rate 8V/ μs typ.
- Bipolar Technology
- Package Outline DIP8, DMP8, SIP8

■ PIN CONFIGURATION

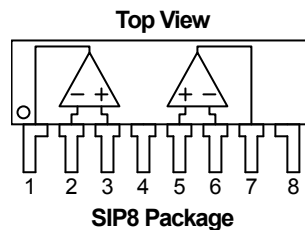
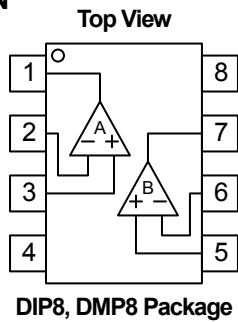

PIN FUNCTION

- 1.A OUTPUT
- 2.A -INPUT
- 3.A +INPUT
- 4.V⁻
- 5.B +INPUT
- 6.B -INPUT
- 7.B OUTPUT
- 8.V⁺

■ EQUIVALENT CIRCUIT (1/2 Shown)

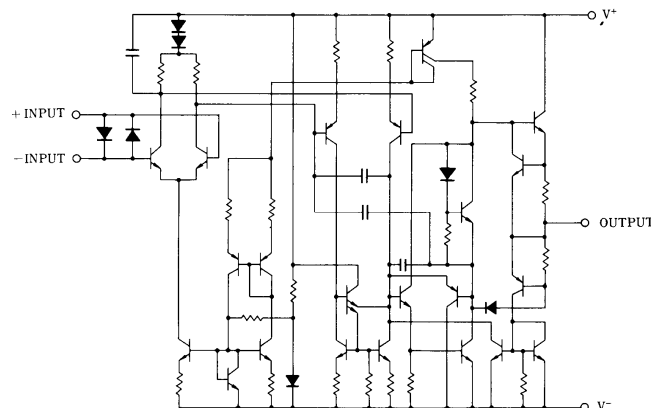

NJM5532

■ ABSOLUTE MAXIMUM RATINGS (Ta=25°C)

PARAMETER	SYMBOL	RATING	UNIT
Supply Voltage	V^+V^-	± 22	V
Common Mode Input Voltage Range	V_{ICM}	V^+V^-	V
Differential Input Voltage Range	V_{ID}	± 0.5	V
Power Dissipation	P_D	DIP8 : 500 DMP8 : 600(Note1) SIP8 : 800	mW
Operating Temperature Range	T_{opr}	-20~+75	°C
Storage Temperature Range	T_{stg}	-40~+125	°C

(Note1) On the cermic PCB (10x20x0.635mm)

■ RECOMMENDED OPERATING VOLTAGE (Ta=25°C)

PARAMETER	SYMBOL	RATING	UNIT
Supply Voltage	V^+V^-	$\pm 3 \sim \pm 22$	V

■ ELECTRICAL CHARACTERISTICS ($V^+V^- = \pm 15V$, Ta=25°C, unless otherwise noted.)

● DC ELECTRICAL CHARACTERISTICS

PARAMETER	SYMBOL	TEST CONDITION	MIN.	TYP.	MAX.	UNIT
Input Offset Voltage	V_{IO}	$R_S \leq 10k\Omega$	-	0.5	4	mV
Input Offset Current	I_{IO}		-	10	150	nA
Input Bias Current	I_B		-	200	800	nA
Supply Current	I_{CC}	$R_L = \infty$	-	9	16	mA
Common Mode Input Voltage Range	V_{ICM}		± 12	± 13	-	V
Common Mode Rejection Ratio	CMR	$R_S \leq 10k\Omega$	70	100	-	dB
Supply Voltage Rejection Ratio	SVR	$R_S \leq 10k\Omega$	80	100	-	dB
Voltage Gain1	A_{V1}	$R_L \geq 2k\Omega, V_O = \pm 10V$	88	100	-	dB
Voltage Gain2	A_{V2}	$R_L \geq 600\Omega, V_O = \pm 10V$	83.5	94	-	dB
Maximum Output Voltage1	V_{OM1}	$R_L \geq 600\Omega$	± 12	± 13	-	V
Maximum Output Voltage2	V_{OM2}	$R_L \geq 600\Omega, V^+V^- = \pm 18V$	± 15	± 16	-	V
Input Resistance	R_{IN}		30	300	-	k Ω
Short Circuit Output Current	I_{OS}		-	38	-	mA

● AC ELECTRICAL CHARACTERISTICS

PARAMETER	SYMBOL	TEST CONDITION	MIN.	TYP.	MAX.	UNIT
Output Resistance	R_O	$A_V = 30dB, f = 10kHz, R_L = 600\Omega$	-	0.3	-	Ω
Overshoot		$A_V = 1, V_{IN} = 100mV_{PP}, R_L = 100pF, R_L = 600\Omega$	-	10	-	%
Voltage Gain	A_V	$f = 10kHz$	-	67	-	dB
Slew Rate	SR		-	8	-	V/ μs
Gain Bandwidth Product	GB	$C_L = 100pF, R_L = 600\Omega$	-	10	-	MHz
Power Bandwidth	W_{PG}	$V_O = \pm 10V$	-	140	-	kHz
	W_{PG}	$V_O = \pm 14V, R_L = 600\Omega, V^+V^- = \pm 18V$	-	100	-	kHz
Equivalent Input Noise Voltage	e_n	$f_O = 30Hz$	-	8	-	nV/ \sqrt{Hz}
	e_n	$f_O = 1kHz$	-	5	-	nV/ \sqrt{Hz}
Equivalent Input Noise Current	i_n	$f_O = 30Hz$	-	2.7	-	pA/ \sqrt{Hz}
	i_n	$f_O = 1kHz$	-	0.7	-	pA/ \sqrt{Hz}
Channel Separation	CS	$f = 1kHz, R_S = 5k\Omega$	-	110	-	dB

■ ELECTRICAL CHARACTERISTICS (D-rank type(Note2), $V^+V^- = \pm 15V$, Ta=25°C, unless otherwise noted.)

PARAMETER	SYMBOL	TEST CONDITION	MIN.	TYP.	MAX.	UNIT
Equivalent Input Noise Voltage	V_{NI}	RIAA, $R_S = 2.2k\Omega$	-	-	1.4	μV_{rms}

(Note2) D-rank type is a Equivalent Input Noise Voltage selected product.

■ TYPICAL CHARACTERISTICS

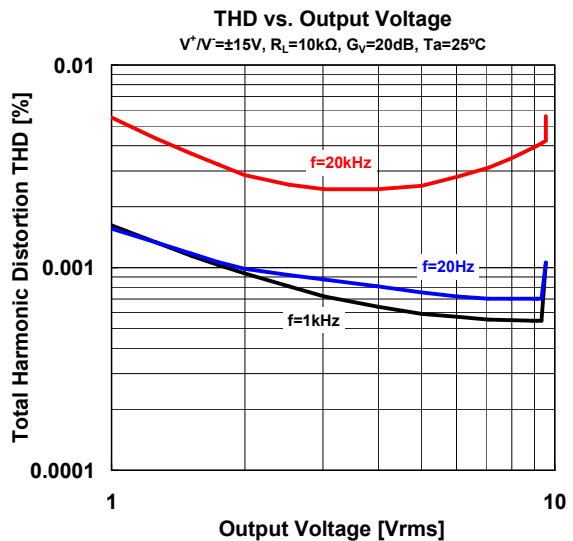
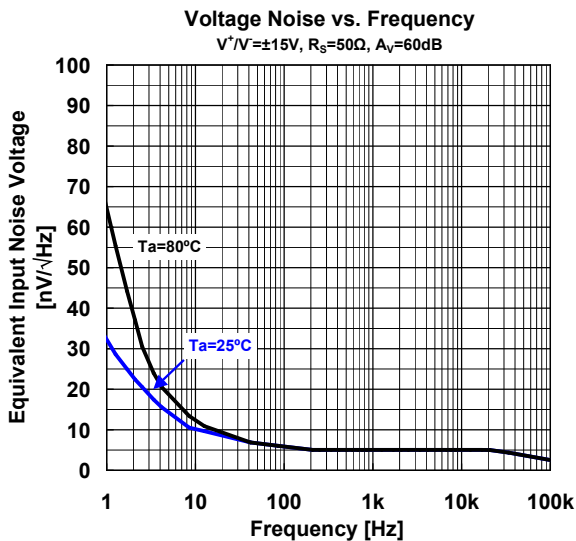
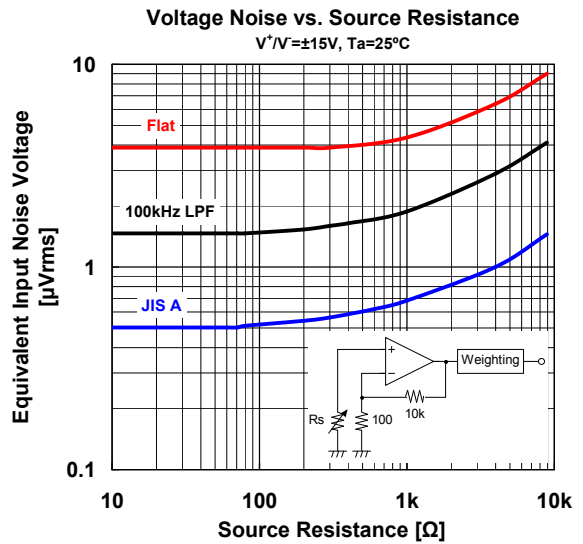
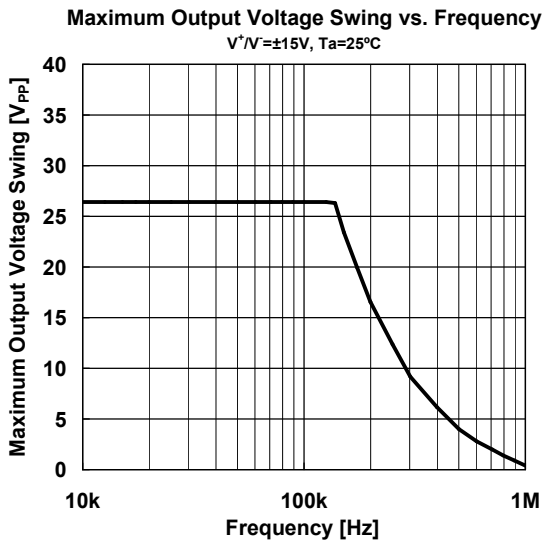
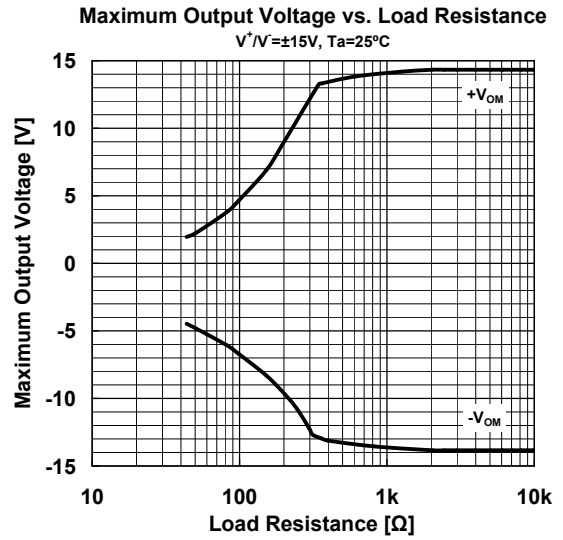
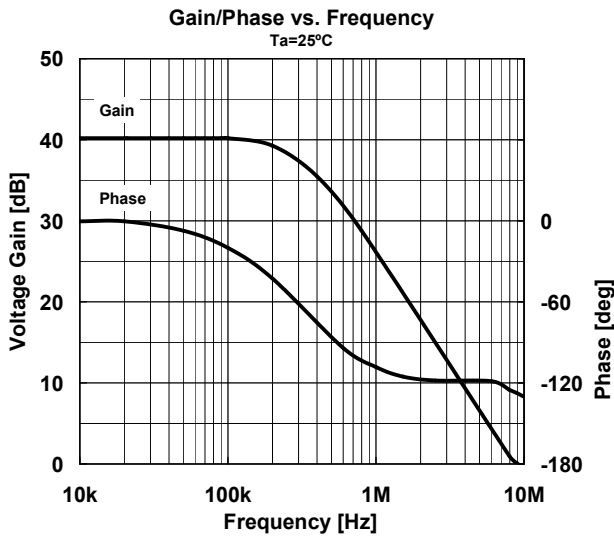

■ TYPICAL CHARACTERISTICS

Supply Current vs. Supply Voltage

$T_a=25^\circ\text{C}$

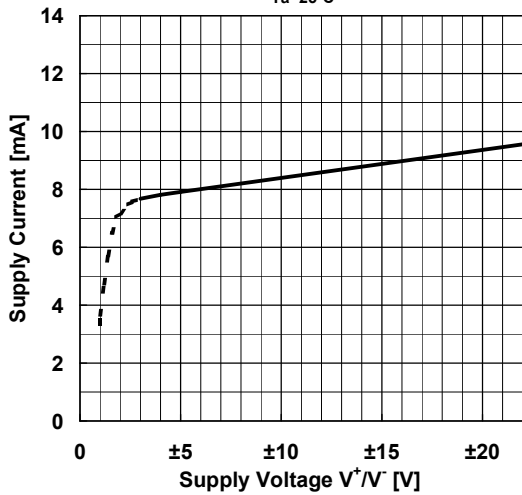

Supply Current vs. Temperature

$V^+/V^-=\pm 15\text{V}$

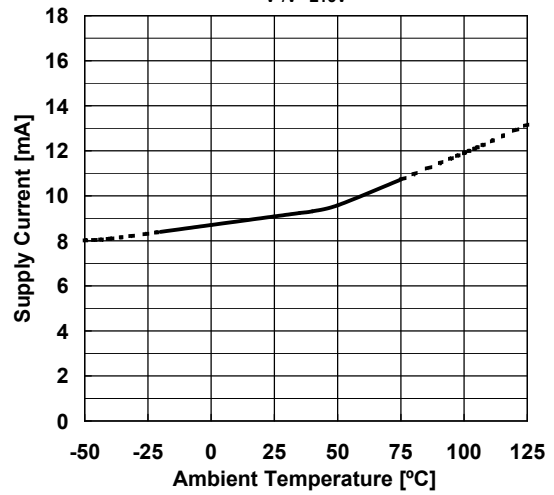

Input Offset Voltage vs. Temperature

$V^+/V^-=\pm 15\text{V}$

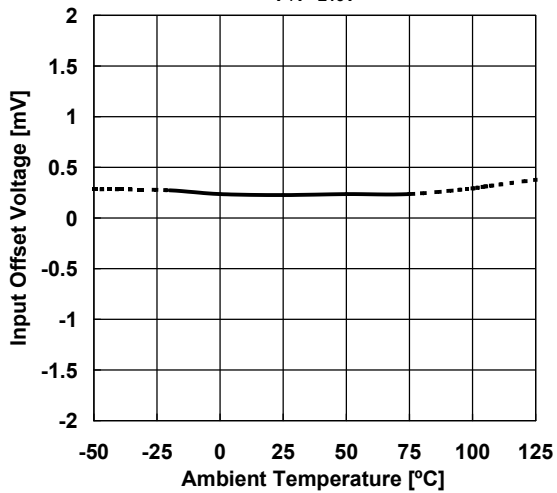

Input Bias Current vs. Temperature

$V^+/V^-=\pm 15\text{V}$

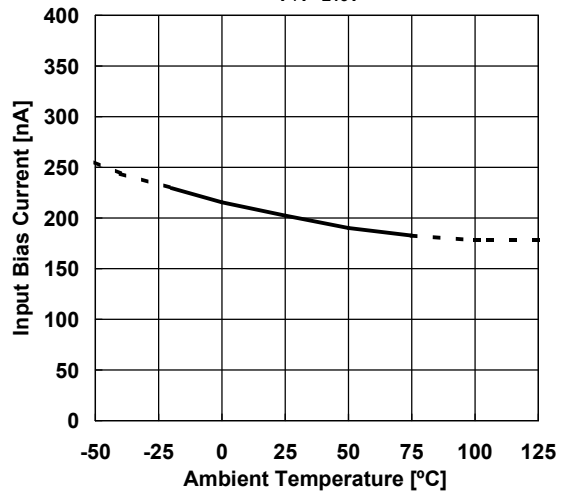

Maximum Output Voltage vs. Supply Voltage

$R_L=2\text{k}\Omega, T_a=25^\circ\text{C}$

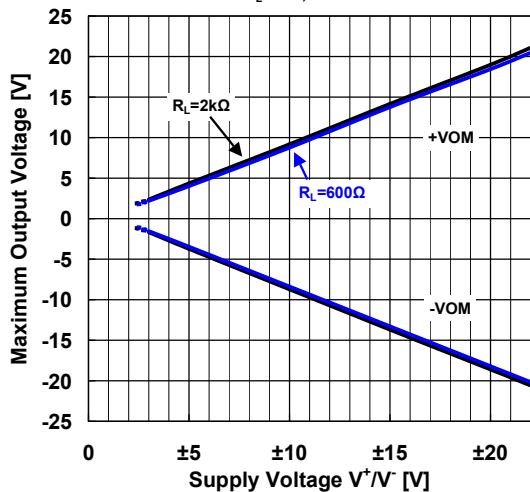

Maximum Output Voltage vs. Temperature

$V^+/V^-=\pm 15\text{V}, R_L=600\Omega$

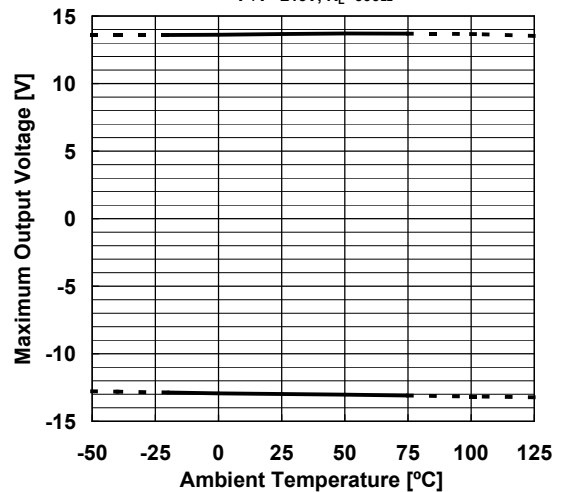

■ TEST CIRCUIT

Noise Voltage (RIAA) measurement circuit

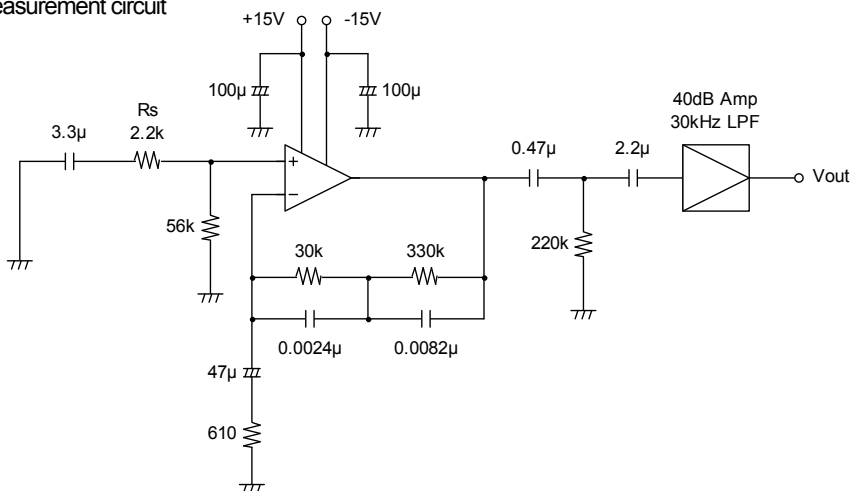

■ NOTICE

When used in voltage follower circuit, put a current limit resistor into non-inverting input terminal in order to avoid inside input diode destruction when the power supply is turned on. (ref.Fig.1)

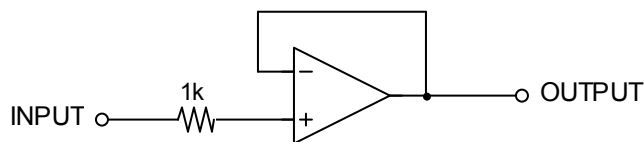

(Fig.1)

[CAUTION]

The specifications on this databook are only given for information, without any guarantee as regards either mistakes or omissions. The application circuits in this databook are described only to show representative usages of the product and not intended for the guarantee or permission of any right including the industrial rights.

X-ON Electronics

Largest Supplier of Electrical and Electronic Components

Click to view similar products for [Operational Amplifiers - Op Amps](#) category:

Click to view products by [JRC](#) manufacturer:

Other Similar products are found below :

[LM358SNG](#) [430227FB](#) [AZV831KTR-G1](#) [LT1678IS8](#) [042225DB](#) [058184EB](#) [SC2902DG](#) [UPC822G2-A](#) [UPC258G2-A](#) [MIC918YC5-TR](#)
[NCS5651MNTXG](#) [NCV33202DMR2G](#) [NJM324E](#) [NTE925](#) [5962-9080901MCA*](#) [AP4310AUMTR-AG1](#) [HA1630D02MMEL-E](#)
[HA1630S01LPEL-E](#) [SCY33178DR2G](#) [NJU77806F3-TE1](#) [NCV5652MUTWG](#) [NCV20034DR2G](#) [LM2902EDR2G](#) [NTE778S](#) [NTE871](#)
[NTE924](#) [NTE937](#) [MCP6V16UT-E/OT](#) [MCP6V17T-E/MS](#) [MCP6V19T-E/ST](#) [SCY6358ADR2G](#) [LTC2065IUD#PBF](#) [NCS20282FCTTAG](#)
[UPC4741G2-E1-A](#) [LM4565FVT-GE2](#) [EL5420CRZ-T7A](#) [TSV791IYLT](#) [TSV772IQ2T](#) [AS324AMTR-E1](#) [TLV2772QPWR](#) [NJM4556AM-TE1](#) [NJM2068M-TE1](#) [AS324MTR-E1](#) [AS358MMTR-G1](#) [MCP6232T-EMNY](#) [MCP662-E/MF](#) [TLC081AIP](#) [TLC082AIP](#) [TLE2074ACDW](#)
[TLV07IDR](#)