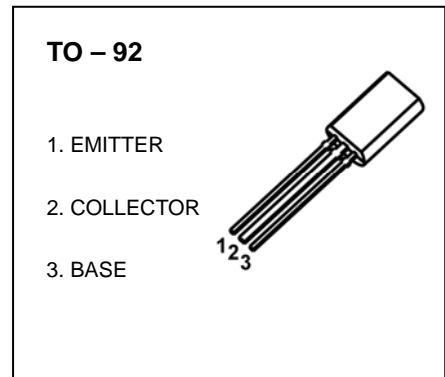
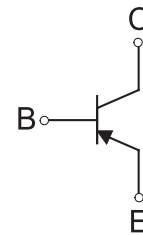

**FEATURES**

- Low Frequency Power Amplifier
- Complementary Pair with 2SD667

**MARKING**

B647=Device code  
 Solid dot = Green molding compound device,  
 if none, the normal device  
 XXX=Code

**Equivalent Circuit**

**MAXIMUM RATINGS (T<sub>a</sub>=25°C unless otherwise noted)**

Symbol	Parameter	Value	Unit
V <sub>CBO</sub>	Collector-Base Voltage	-120	V
V <sub>CEO</sub>	Collector-Emitter Voltage	-80	V
V <sub>EBO</sub>	Emitter-Base Voltage	-5	V
I <sub>C</sub>	Collector Current	-1	A
P <sub>C</sub>	Collector Power Dissipation	750	mW
R <sub>θJA</sub>	Thermal Resistance From Junction To Ambient	167	°C/W
T <sub>J</sub> , T <sub>stg</sub>	Operation Junction and Storage Temperature Range	-55~+150	°C

**ELECTRICAL CHARACTERISTICS**
 $T_a=25\text{ }^\circ\text{C}$  unless otherwise specified

Parameter	Symbol	Test conditions	Min	Typ	Max	Unit
Collector-base breakdown voltage	$V_{(BR)CBO}$	$I_C=-10\mu\text{A}, I_E=0$	-120			V
Collector-emitter breakdown voltage	$V_{(BR)CEO}$	$I_C=-1\text{mA}, I_B=0$	-80			V
Emitter-base breakdown voltage	$V_{(BR)EBO}$	$I_E=-10\mu\text{A}, I_C=0$	-5			V
Collector cut-off current	$I_{CBO}$	$V_{CB}=-100\text{V}, I_E=0$			-10	$\mu\text{A}$
DC current gain	$h_{FE(1)}$	$V_{CE}=-5\text{V}, I_C=-150\text{mA}$	60		320	
	$h_{FE(2)}$	$V_{CE}=-5\text{V}, I_C=-500\text{mA}$	30			
Collector-emitter saturation voltage	$V_{CE(sat)}$	$I_C=-500\text{mA}, I_B=-50\text{mA}$			-1	V
Base-emitter voltage	$V_{BE}$	$V_{CE}=-5\text{V}, I_C=-150\text{mA}$			-1.5	V
Collector output capacitance	$C_{ob}$	$V_{CB}=-10\text{V}, I_E=0, f=1\text{MHz}$		20		pF
Transition frequency	$f_T$	$V_{CE}=-5\text{V}, I_C=-150\text{mA}$		140		MHz

\*Pulse test

**CLASSIFICATION OF  $h_{FE(1)}$** 

RANK	B	C	D
RANGE	60-120	100-200	160-320

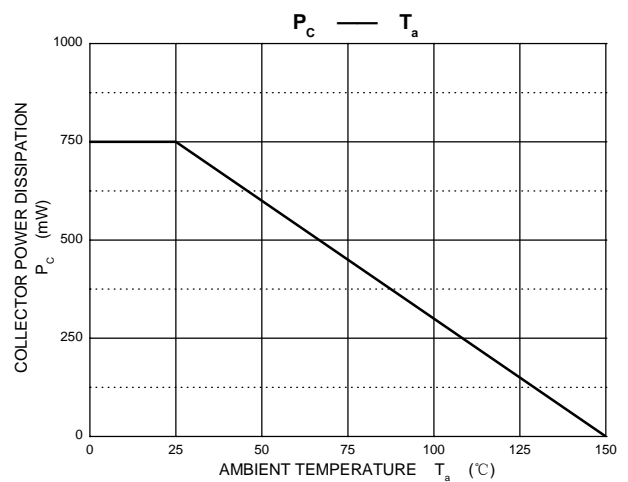
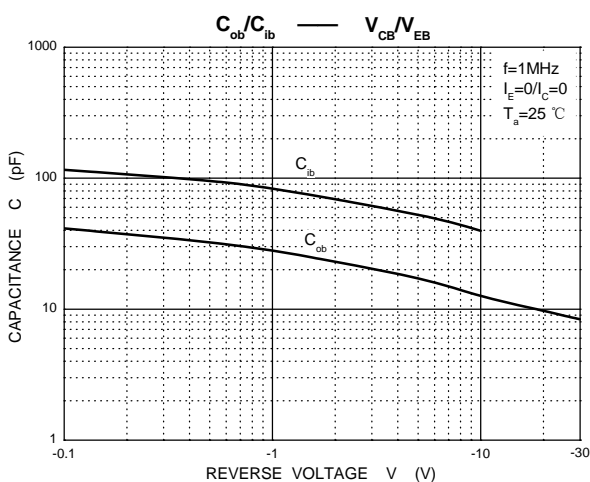
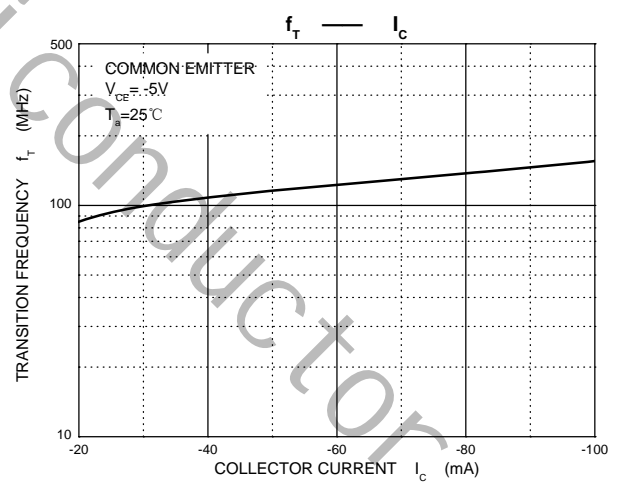
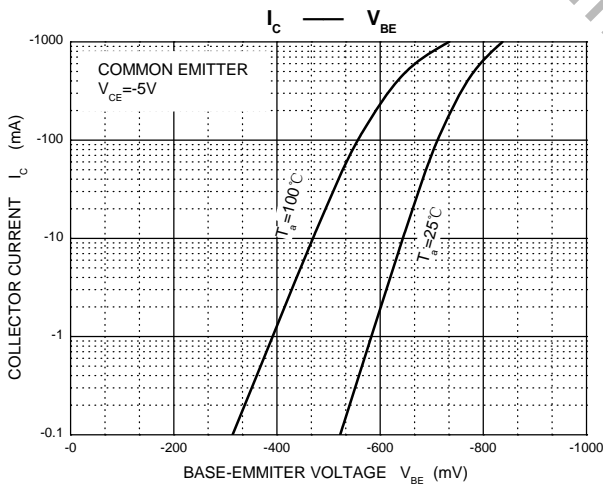
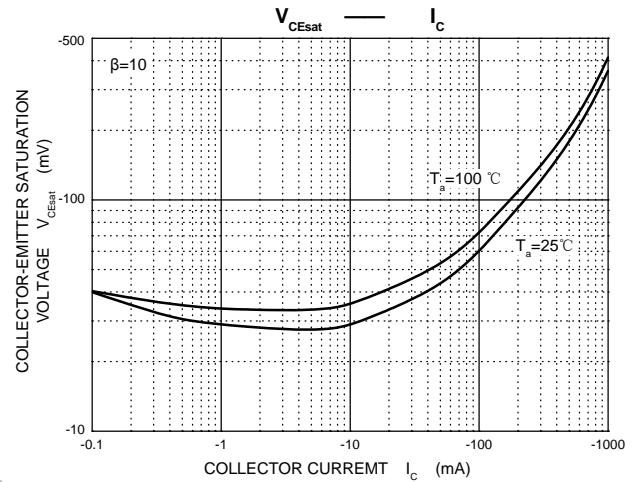
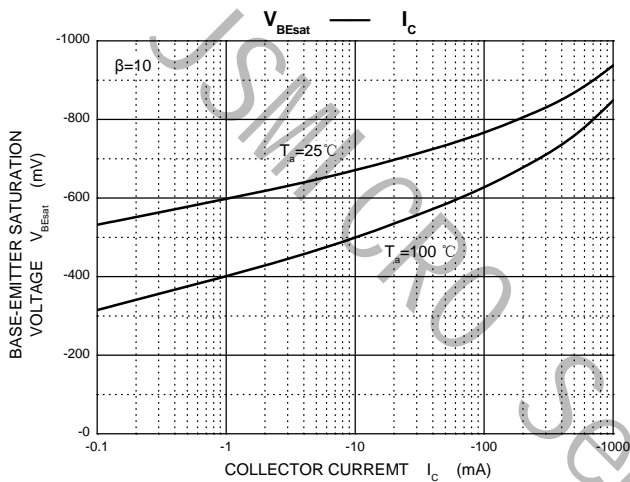
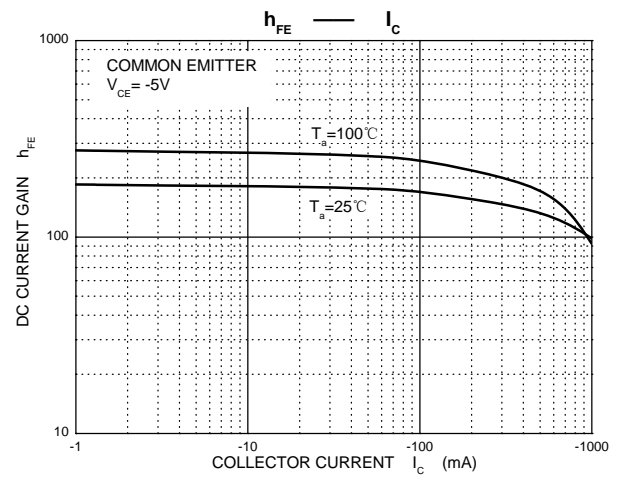
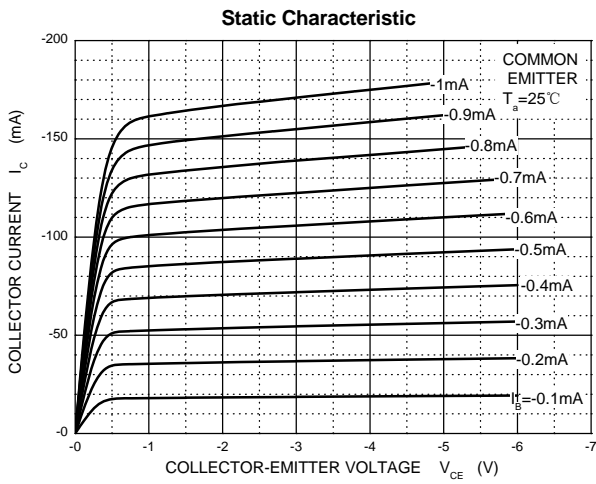

## X-ON Electronics

Largest Supplier of Electrical and Electronic Components

*Click to view similar products for [Bipolar Transistors - BJT category](#):*

*Click to view products by [JSMSEMI manufacturer](#):*

Other Similar products are found below :

[BC559C](#) [MCH4017-TL-H](#) [MMBT-2369-TR](#) [BC546/116](#) [NJVMJD148T4G](#) [NTE16](#) [NTE195A](#) [IMX9T110](#) [2N4401-A](#) [2N4403](#) [2N6728](#)  
[2SA1419T-TD-H](#) [2SA2126-E](#) [2SB1204S-TL-E](#) [FMC5AT148](#) [2N2369ADCSM](#) [2N2907A](#) [2N3904-NS](#) [2N5769](#) [2SC4618TLN](#) [CPH6501-](#)  
[TL-E](#) [MCH4021-TL-E](#) [Jantx2N5416](#) [US6T6TR](#) [BAX18/A52R](#) [BC556/112](#) [IMZ2AT108](#) [MMST8098T146](#) [UMX21NTR](#) [MCH6102-TL-E](#)  
[TTA1452B,S4X\(S](#) [2N3879](#) [NTE13](#) [NTE282](#) [NTE323](#) [NTE350](#) [NTE81](#) [JANTX2N2920L](#) [JANTX2N3735](#) [JANSR2N2222AUB](#)  
[CMLT3946EG TR](#) [SNSS40600CF8T1G](#) [CMLT3906EG TR](#) [GRP-DATA-JANS2N2907AUB](#) [GRP-DATA-JANS2N2222AUA](#)  
[MMDT3946FL3-7](#) [2N4240](#) [MSB30KH-13](#) [2N2221AUB](#) [2SD1815T-TL-E](#)