

FEATURES

- Low noise and high gain.
 $NF=1.1\text{dB TYP.}, G_a=11\text{dB TYP.}$
 $@V_{CE}=10\text{V}, I_C=7\text{mA}, f=1.0\text{GHz}$
- High power gain. $MAG=13\text{dB TYP.}$
 $@V_{CE}=10\text{V}, I_C=20\text{mA}, f=1.0\text{GHz.}$

APPLICATIONS

- Designed for low noise amplifier at VHF, UHF and CATV band.

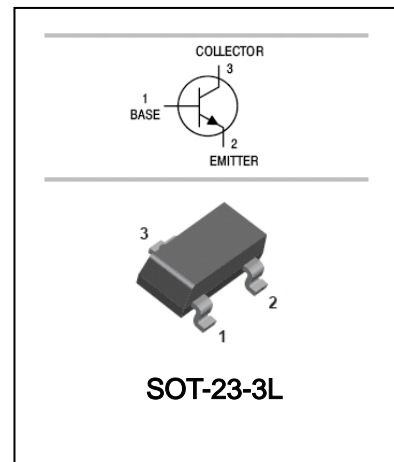

ORDERING INFORMATION

Type No.	Marking	Package Code
2SC3356-R25	R25	SOT-23-3L

MAXIMUM RATING @ $T_a=25^\circ\text{C}$ unless otherwise specified

Symbol	Parameter	Value	Units
V_{CBO}	Collector-Base Voltage	20	V
V_{CEO}	Collector-Emitter Voltage	12	V
V_{EBO}	Emitter-Base Voltage	3	V
I_C	Collector Current -Continuous	100	mA
P_C	Collector Dissipation	200	mW
T_j, T_{stg}	Junction and Storage Temperature	-65 to +150	$^\circ\text{C}$

ELECTRICAL CHARACTERISTICS @ Ta=25°C unless otherwise specified

Parameter	Symbol	Test conditions	MIN	TYP	MAX	UNIT
Collector-base breakdown voltage	$V_{(BR)CBO}$	$I_C=10\mu A, I_E=0$	20			V
Collector-emitter breakdown voltage	$V_{(BR)CEO}$	$I_C=1mA, I_B=0$	12			V
Emitter-base breakdown voltage	$V_{(BR)EBO}$	$I_E=10\mu A, I_C=0$	3			V
Collector cut-off current	I_{CBO}	$V_{CB}=10V, I_E=0$			1	μA
Emitter cut-off current	I_{EBO}	$V_{EB}=1V, I_C=0$			1	μA
DC current gain	h_{FE}	$V_{CE}=10V, I_C=20mA$	50	120	300	
Transition frequency	f_T	$V_{CE}=10V, I_C=20mA$		7		GHz
Insertion power gain	$ S_{21e} ^2$	$V_{CE}=10V, I_C=20mA, f=1GHz$		11.5		dB
Feed-back capacitance	C_{re}	$V_{CB}=10V, I_E=0, f=1MHz$		0.55	1.0	pF
Noise Figure	NF	$V_{CE}=10V, I_C=7mA, f=1GHz$		1.1	2.0	dB

 CLASSIFICATION OF h_{FE}

Range	125-250
Marking	R25

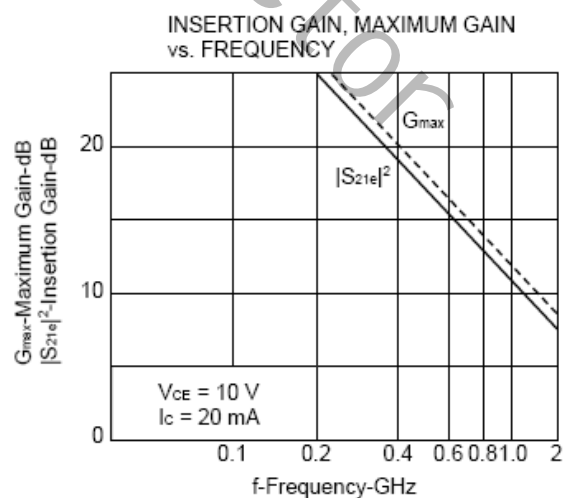
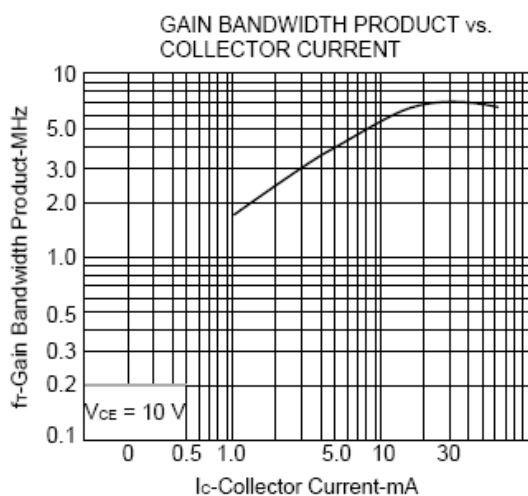
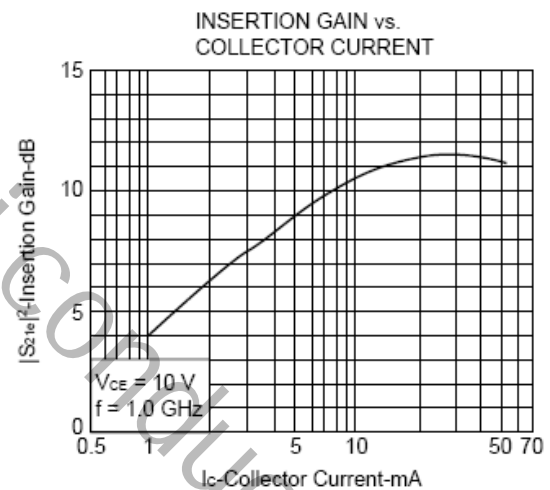
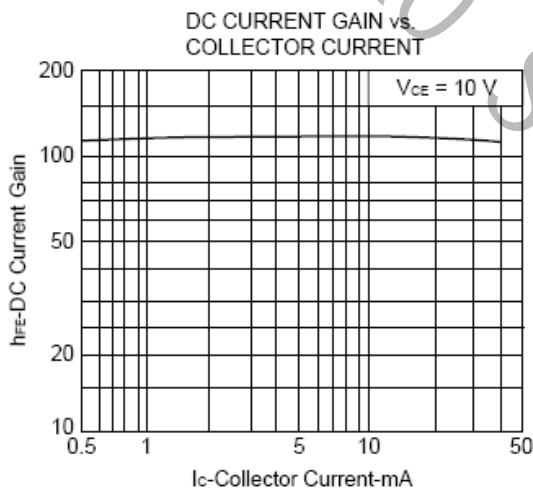
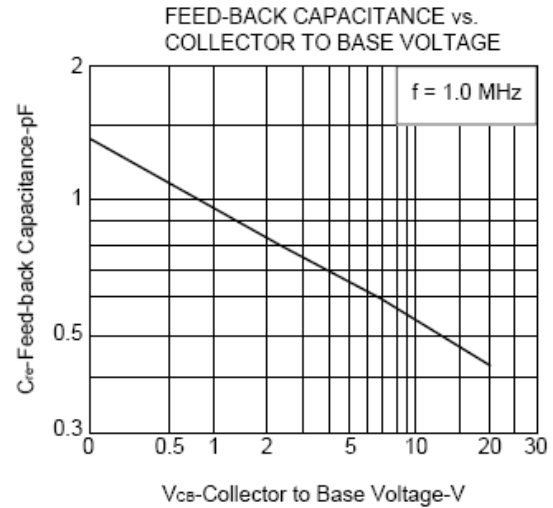
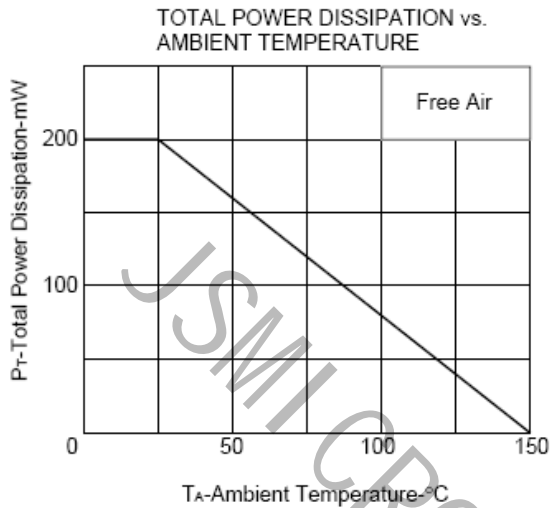
TYPICAL CHARACTERISTICS @ $T_a=25^\circ\text{C}$ unless otherwise specified

PACKAGE OUTLINE

Plastic surface mounted package

SOT-23-3L

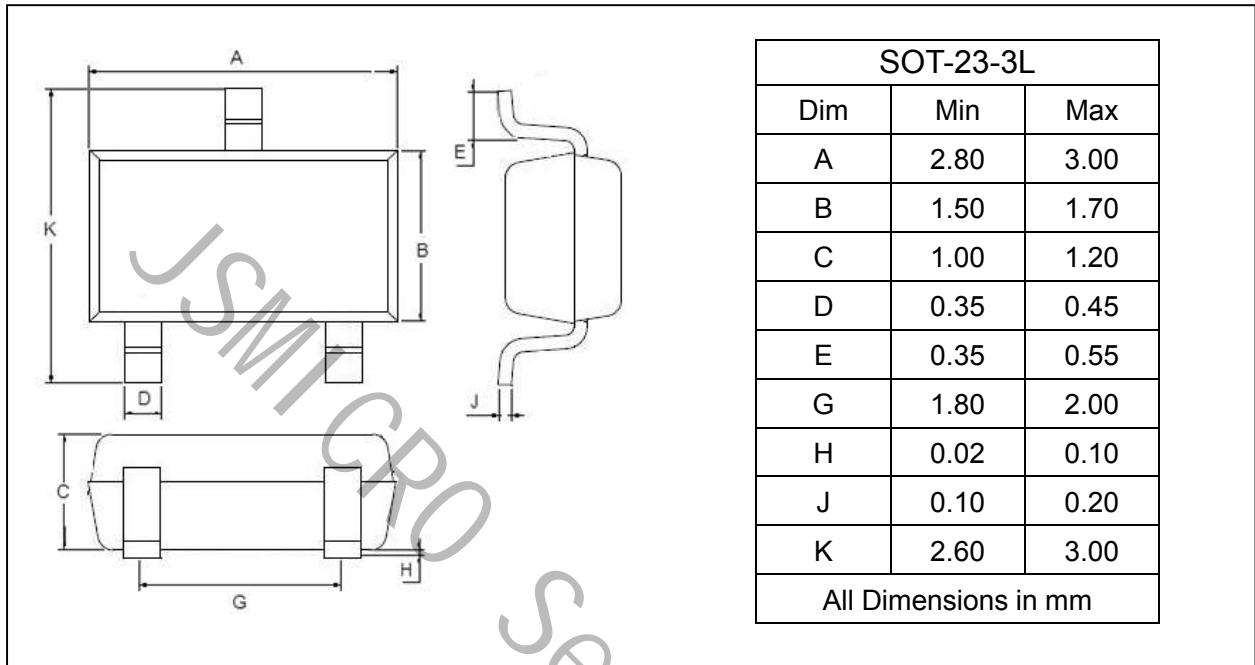

SOLDERING FOOTPRINT

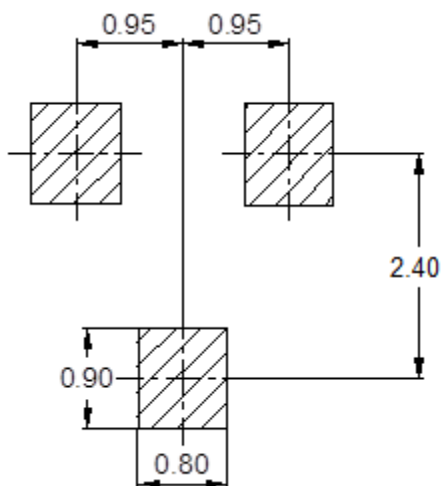

Unit : mm

PACKAGE INFORMATION

Device	Package	Shipping
2SC3356-R25	SOT-23-3L	3000/Tape&Reel

X-ON Electronics

Largest Supplier of Electrical and Electronic Components

Click to view similar products for [Bipolar Transistors - BJT category](#):

Click to view products by [JSMSEMI manufacturer](#):

Other Similar products are found below :

[619691C](#) [MCH4017-TL-H](#) [MMBT-2369-TR](#) [BC546/116](#) [BC557/116](#) [BSW67A](#) [NJVMJD148T4G](#) [NTE123AP-10](#) [NTE153MCP](#) [NTE16](#)
[NTE195A](#) [NTE92](#) [2N4401-A](#) [2N6728](#) [2SA1419T-TD-H](#) [2SA2126-E](#) [2SB1204S-TL-E](#) [2SC2712S-GR,LF](#) [2SC4731T-AY](#) [FJPF5304DTU](#)
[2N2907A](#) [2N3904-NS](#) [2N5769](#) [2SB1324-TD-E](#) [2SC2412KT146S](#) [2SC3332T](#) [2SC3902S](#) [2SC5231C8-TL-E](#) [2SD1685F](#) [CPH6501-TL-E](#)
[MCH4021-TL-E](#) [MJE340](#) [Jantx2N5416](#) [US6T6TR](#) [NJL0281DG](#) [732314D](#) [CPH3121-TL-E](#) [CPH6021-TL-H](#) [873787E](#) [IMZ2AT108](#)
[UMX21NTR](#) [MCH6102-TL-E](#) [NJL0302DG](#) [TTA1452B,S4X\(S](#) [NTE13](#) [NTE26](#) [NTE282](#) [NTE323](#) [NTE350](#) [NTE81](#)