

■ DESCRIPTION

The 4406A is the N-Channel logic enhancement mode power field effect transistor is produced using high cell density advanced trench technology..

This high density process is especially tailored to minimize on-state resistance.

This device is suitable for use as a load switch or in PWM and gate charge for most of the synchronous buck converter applications

■ FEATURE

- ◆ 30V/15A, $R_{DS(ON)} = 8.5m\Omega$ (typ.)@ $V_{GS}=10V$
- ◆ 30V/11A, $R_{DS(ON)} = 14m\Omega$ (typ.)@ $V_{GS}=4.5V$
- ◆ Super high design for extremely low $R_{DS(ON)}$
- ◆ Exceptional on-resistance and Maximum DC current capability
- ◆ Full RoHS compliance
- ◆ SOP8 package design

■ APPLICATIONS

- ◆ High Frequency Point-of-Load Synchronous
- ◆ Newworking DC-DC Power System
- ◆ Load Switch

■ PIN CONFIGURATION

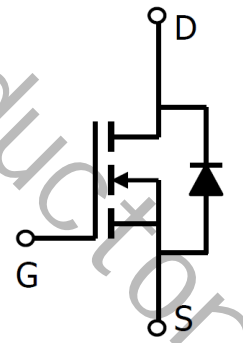
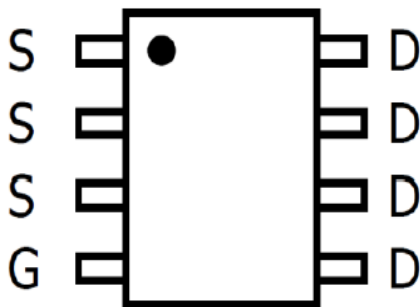

■ ORDERING INFORMATION

Part Number	Package Code	Package	Shipping
AO4406A	4406A	SOP8	3000EA / T&R

※ Year Code : 0~9

※ Week Code : A~Z(1-26); a~z(27~52)

※ G : Green Product. This product is RoHS compliant.

■ ABSOLUTE MAXIMUM RATINGS ($T_A = 25^\circ\text{C}$ Unless otherwise noted)

Symbol	Parameter	Typical	Unit
V_{DSS}	Drain-Source Voltage	30	V
V_{GSS}	Gate-Source Voltage	±20	V
I_D	Continuous Drain Current ($T_A=25^\circ\text{C}$)	15	A
	Continuous Drain Current ($T_A=70^\circ\text{C}$)	12	a
I_{DM}	Pulsed Drain Current	40	A
I_S	Continuous Source Current (Diode Conduction)	2.0	A
P_D	Power Dissipation	$T_A=25^\circ\text{C}$	3.0
		$T_A=70^\circ\text{C}$	2.1
T_J	Operation Junction Temperature	150	$^\circ\text{C}$
T_{STG}	Storage Temperature Range	-55~+150	$^\circ\text{C}$
$R_{\theta JA}$	Thermal Resistance Junction to Ambient	85	$^\circ\text{C/W}$

Note: Absolute maximum ratings are those values beyond which the device could be permanently damaged.

Absolute maximum ratings are stress rating only and functional device operation is not implied

ELECTRICAL CHARACTERISTICS ($T_A=25^\circ\text{C}$ Unless otherwise noted)

Symbol	Parameter	Condition	Min	Typ	Max	Unit
Static Parameters						
$V_{(BR)DSS}$	Drain-Source Breakdown Voltage	$V_{GS}=0V, I_D=250\mu A$	30			V
$V_{GS(th)}$	Gate Threshold Voltage	$V_{DS}=V_{GS}, I_D=250\mu A$	1.0	1.9	3.0	V
I_{GSS}	Gate Leakage Current	$V_{DS}=0V, V_{GS}=\pm 20V$			± 100	nA
I_{DSS}	Zero Gate Voltage Drain Current	$V_{DS}=24V, V_{GS}=0$			1	uA
		$V_{DS}=24V, V_{GS}=0$ $T_J=55^\circ\text{C}$			5	
$R_{DS(ON)}$	Drain-Source On-Resistance	$V_{GS}=10V, I_D=15A$		8.5	11	m Ω
		$V_{GS}=4.5V, I_D=11A$		14	18	
Source-Drain Diode						
V_{SD}	Diode Forward Voltage	$I_S=1.0A, V_{GS}=0V$		0.71	1.0	V
Dynamic Parameters						
Q_g	Total Gate Charge	$V_{DS}=15V$		16	20.8	nC
Q_{gs}	Gate-Source Charge	$V_{GS}=4.5V$		5	6.5	
Q_{gd}	Gate-Drain Charge	$I_D=14A$		3	3.9	
C_{iss}	Input Capacitance	$V_{DS}=15V$		2470		pF
C_{oss}	Output Capacitance	$V_{GS}=0V$		325		
C_{rss}	Reverse Transfer Capacitance	$f=1\text{MHz}$		185		
$T_{d(on)}$	Turn-On Time	$V_{DS}=15V$		17	34	nS
T_r		$I_D=14A$		5	10	
$T_{d(off)}$	Turn-Off Time	$V_{GEN}=10V$		50	100	
T_f		$R_G=6\Omega$		10	20	

Note: 1. Pulse test: pulse width \leq 300uS, duty cycle \leq 2%

2.Static parameters are based on package level with recommended wire bonding

■ **TYPICAL CHARACTERISTICS (25°C Unless Note)**

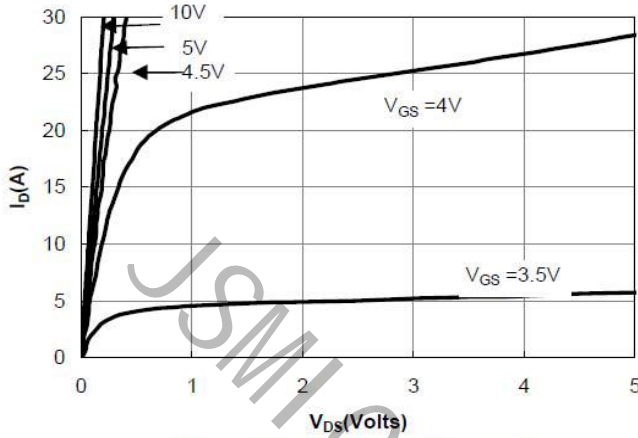

Figure 1: On-Regions Characteristics

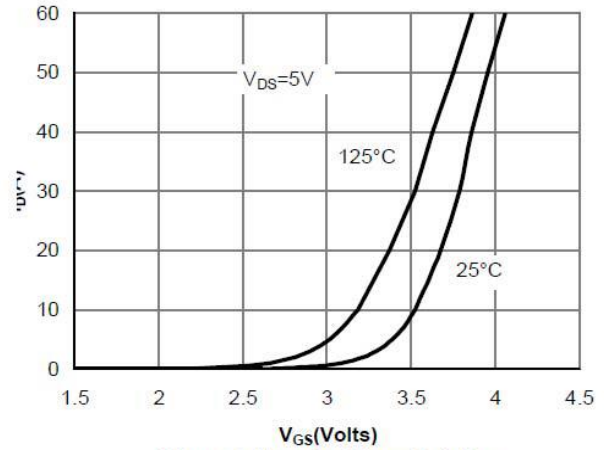

Figure 2: Transfer Characteristics

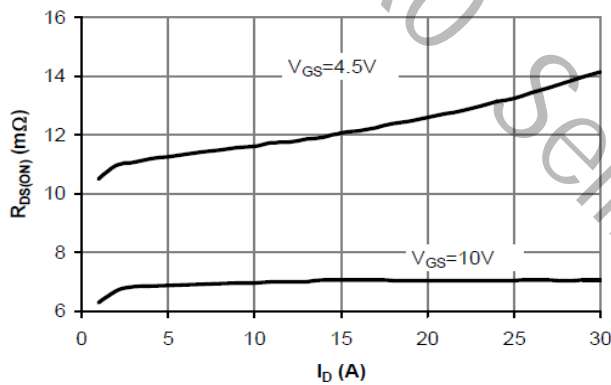

Figure 3: On-Resistance vs. Drain Current and Gate Voltage

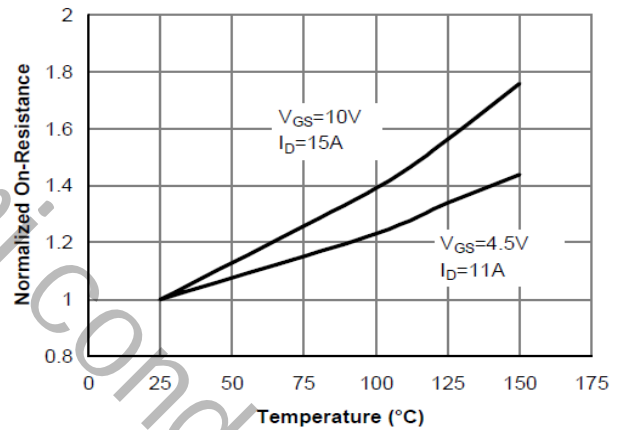

Figure 4: On-Resistance vs. Junction Temperature

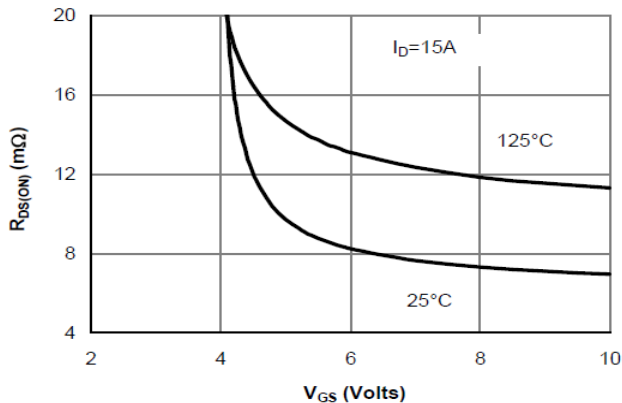

Figure 5: On-Resistance vs. Gate-Source Voltage

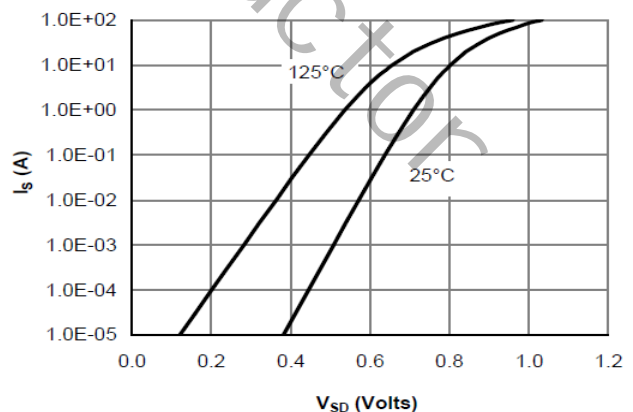

Figure 6: Body-Diode Characteristics

■ **TYPICAL CHARACTERISTICS** (continuous)

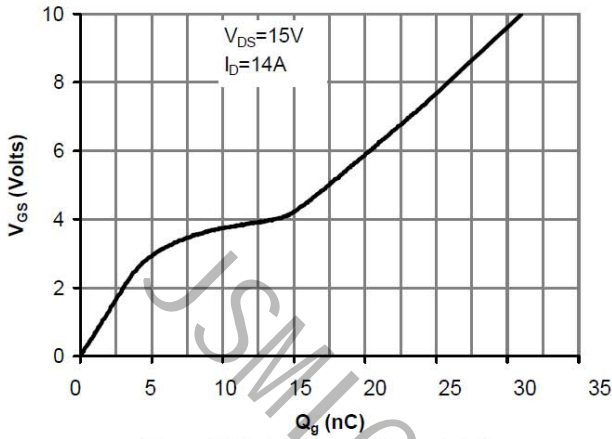

Figure 7: Gate-Charge Characteristics

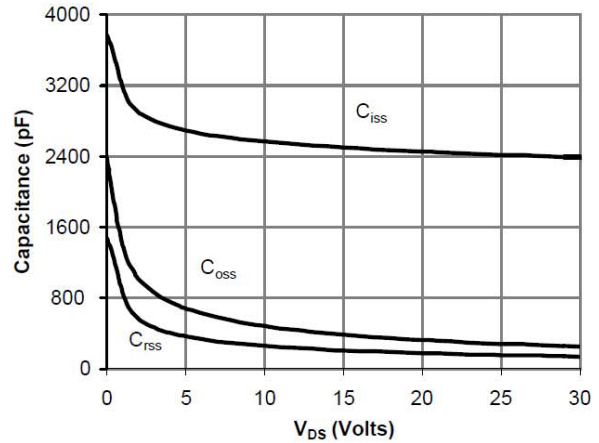

Figure 8: Capacitance Characteristics

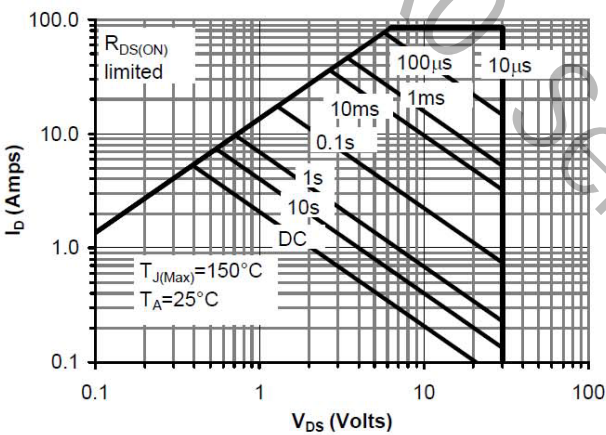

Figure 9: Maximum Forward Biased Safe Operating Area

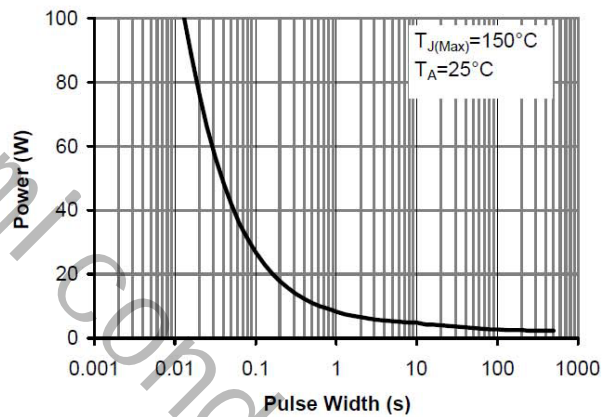

Figure 10: Single Pulse Power Rating Junction-to-Ambient

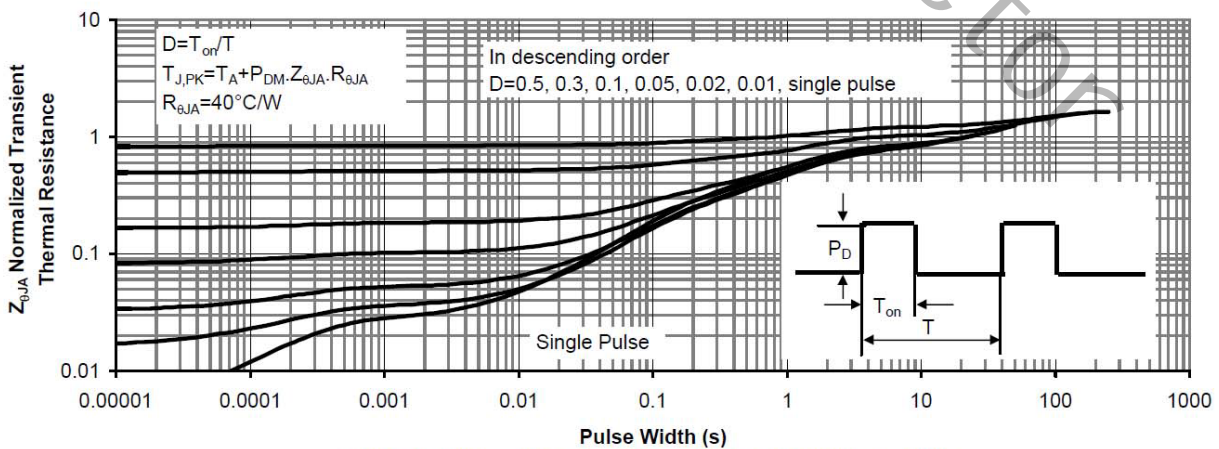
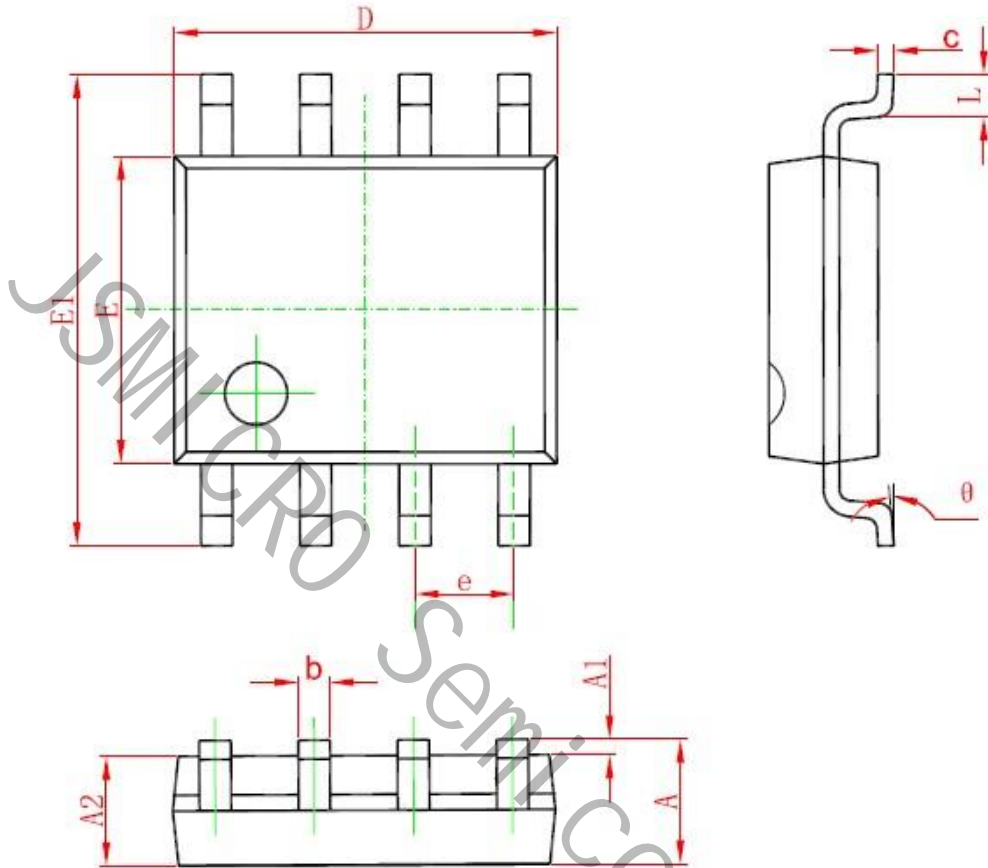

Figure 11: Normalized Maximum Transient Thermal Impedance

■ SOP8 PACKAGE OUTLINE DIMENSIONS

Symbol	Dimensions In Millimeters		Dimensions In Inches	
	Min	Max	Min	Max
A	1.350	1.750	0.053	0.069
A1	0.100	0.250	0.004	0.010
A2	1.350	1.550	0.053	0.061
b	0.330	0.510	0.013	0.020
c	0.170	0.250	0.006	0.010
D	4.700	5.100	0.185	0.200
E	3.800	4.000	0.150	0.157
E1	5.800	6.200	0.228	0.244
e	1.270 (BSC)		0.050 (BSC)	
L	0.400	1.270	0.016	0.050
theta	0°	8°	0°	8°

■ SOLDERING METHODS FOR UNIVERCHIP

Storage environment Temperature=10°C~35°C Humidity=65%±15%

Reflow soldering of surface mount device

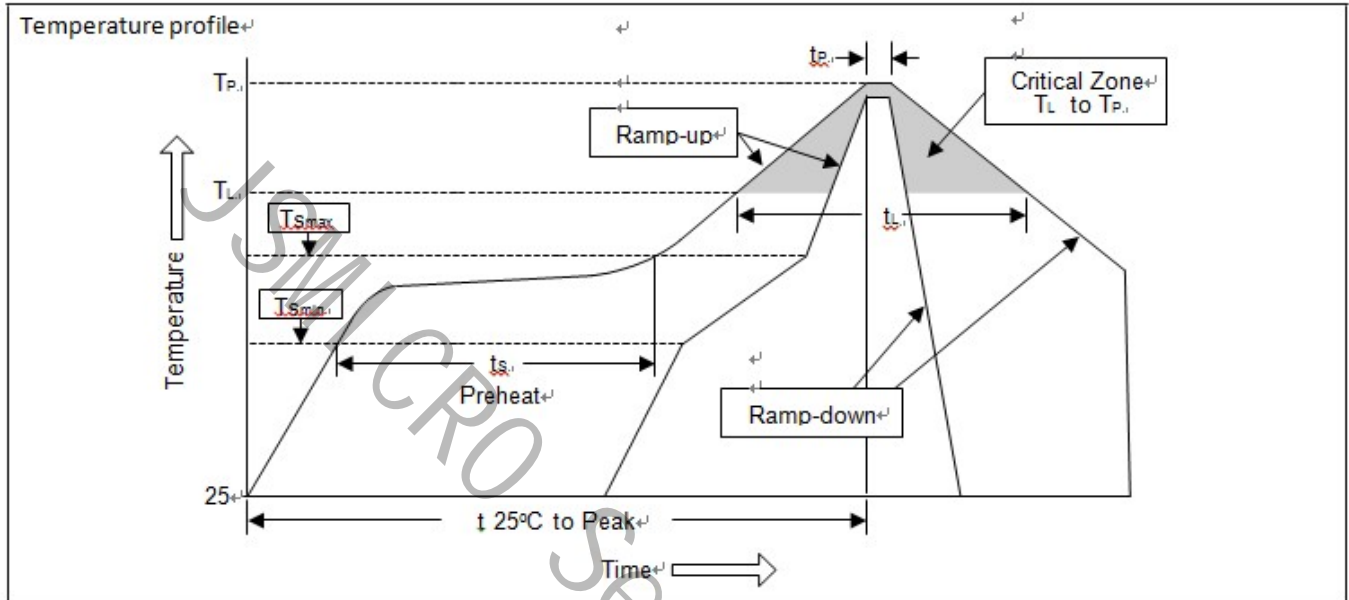

Profile Feature	Sn-Pb Eutectic Assembly	Pb free Assembly
Average ramp-up rate (T _L to T _P)	<3°C/sec	<3°C/sec
Preheat		
-Temperature Min (T _{Smin})	100°C	150°C
-Temperature Max (T _{Smax})	150°C	200°C
-Time (min to max) (t _s)	60~120 sec	60~180 sec
T _{Smax} to T _L		
-Ramp-up Rate	<3°C/sec	<3°C/sec
Time maintained above		
-Temperature (T _L)	183°C	217°C
-Time (t _L)	60~150 sec	60~150 sec
Peak Temperature (T _P)	240°C+0/-5°C	260°C+0/-5°C
Time within 5°C of actual Peak Temperature (t _p)	10~30 sec	20~40 sec
Ramp-down Rate	<6°C/sec	<6°C/sec
Time 25°C to Peak Temperature	<6 minutes	<6 minutes

Flow (wave) soldering (solder dipping)

Product	Peak Temperature	Dipping Time
Pb device	245°C±5°C	5sec±1sec
Pb-Free device	260°C+0/-5°C	5sec±1sec



This integrated circuit can be damaged by ESD. UniverChip Corporation recommends that all integrated circuits be handled with appropriate precautions. Failure to observe proper handling and installation procedure can cause damage. ESD damage can range from subtle performance degradation to complete device failure. Precision integrated circuits may be more susceptible to damage because very small parametric changes could cause the device not to meet its published specifications.

JSMICRO Semi conductor

X-ON Electronics

Largest Supplier of Electrical and Electronic Components

Click to view similar products for [MOSFET](#) category:

Click to view products by [JSMSEMI](#) manufacturer:

Other Similar products are found below :

[IRFD120](#) [JANTX2N5237](#) [2SK2267\(Q\)](#) [BUK455-60A/B](#) [TK100A10N1,S4X\(S](#) [MIC4420CM-TR](#) [VN1206L](#) [NDP4060](#) [SI4482DY](#)
[IRS2092STRPBF-EL](#) [IPS70R2K0CEAKMA1](#) [TK31J60W5,S1VQ\(O](#) [TK31J60W,S1VQ\(O](#) [TK16J60W,S1VQ\(O](#) [2SK2614\(TE16L1,Q\)](#)
[DMN1017UCP3-7](#) [EFC2J004NUZTDG](#) [P85W28HP2F-7071](#) [DMN1053UCP4-7](#) [NTE2384](#) [DMC2700UDMQ-7](#) [DMN2080UCB4-7](#)
[DMN61D9UWQ-13](#) [US6M2GTR](#) [DMN31D5UDJ-7](#) [DMP22D4UFO-7B](#) [IPS60R3K4CEAKMA1](#) [DMN1006UCA6-7](#) [DMN16M9UCA6-7](#)
[STF5N65M6](#) [IRF40H233XTMA1](#) [STU5N65M6](#) [DMN6022SSD-13](#) [DMN13M9UCA6-7](#) [DMTH10H4M6SPS-13](#) [IPS60R360PFD7SAKMA1](#)
[DMN2990UFB-7B](#) [SSM3K35CT,L3F](#) [IPLK60R1K0PFD7ATMA1](#) [2N7002W-G](#) [MCAC30N06Y-TP](#) [IPWS65R035CFD7AXKSA1](#)
[MCQ7328-TP](#) [SSM3J143TU,LXHF](#) [DMN12M3UCA6-7](#) [PJMF280N65E1_T0_00201](#) [PJMF380N65E1_T0_00201](#)
[PJMF280N60E1_T0_00201](#) [PJMF600N65E1_T0_00201](#) [PJMF900N65E1_T0_00201](#)