

**描述 / Descriptions**

TO-220 塑封封装 双向可控硅。  
 Triac in a TO-220 Plastic Package.

**特征 / Features**

采用玻璃钝化技术，采用环氧塑脂塑料封装，  
 四个信号区都可以满足高灵敏度需要。

glass passivated, sensitive gate triacs in a  
 plastic envelope, where high sensitivity is  
 required in all four quadrants.

**用途 / Applications**

用于一般双向开关和相位控制。

Use in general purpose bidirectional switching  
 and phase control applications.

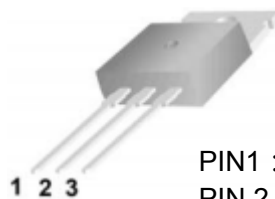

PIN1 : Main Terminal 1  
 PIN 2 : Main Terminal 2  
 PIN 3 : Gate

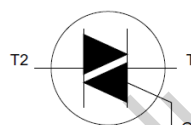

**极限参数 / Absolute Maximum Ratings (Ta=25°C)**

参数 Parameter	符号 Symbol	数值 Rating		单位 Unit
		600	800	
Repetitive peak off-state voltages	$V_{DRM}$ ( $T_j=25^\circ\text{C}$ )	600	800	V
RMS on-state current	$I_{T(RMS)}$	16		A
Non-repetitive peak on-state current	$I_{TSM}(t=20\text{ms})$	155		A
Non-repetitive peak on-state current	$I_{TSM}(t=16.7\text{ms})$	170		A
$I_t^2$ for fusing	$I_t^2 t(t=10\text{ms})$	120		A <sup>2</sup> S
Repetitive rate of rise of on-state current after triggering	$I_{TM}=12\text{A}$ $I_G=0.2\text{A}$ $dI_G/dt=0.2\text{A}/\mu\text{s}$	T2+G+	50	A/ $\mu\text{S}$
		T2+G-	50	A/ $\mu\text{S}$
		T2-G-	50	A/ $\mu\text{S}$
		T2-G+	10	A/ $\mu\text{S}$
Peak gate current	$I_{GM}$	2.0		A
Peak gate voltages	$V_{GM}$	5.0		V
Peak gate power	$P_{GM}$	5.0		W
Average gate power (Over any 20 ms period)	$P_{G(AV)}$	0.5		W
Junction Temperature	$T_j$	125		°C
Storage Temperature Range	$T_{stg}$	-40~150		°C
Thermal resistance junction to ambient	$R_{th(j-a)}$	60		K/W
Thermal resistance junction to mounting base	$R_{th(j-b)}$	1.2		K/W

**电性能参数 / Electrical Characteristics(Ta=25°C)**

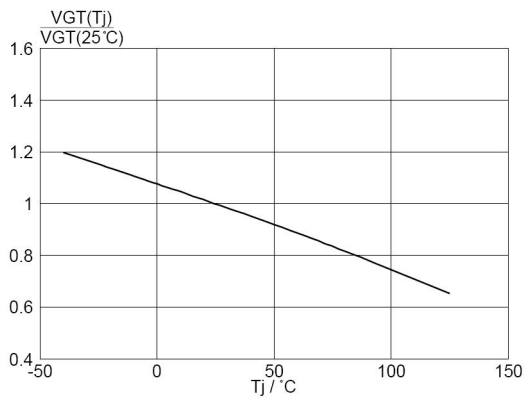
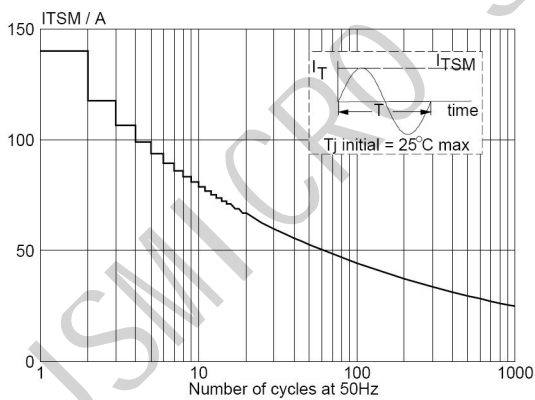
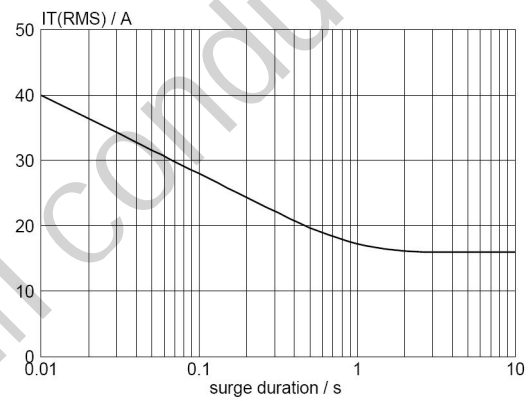
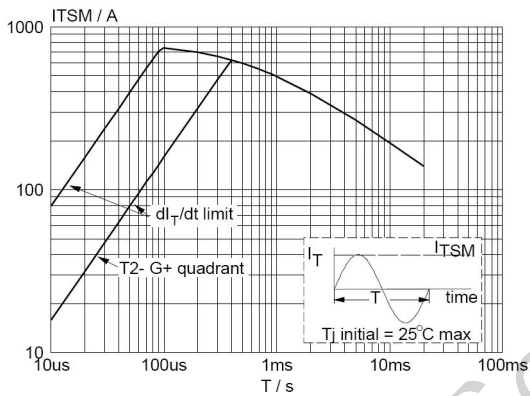
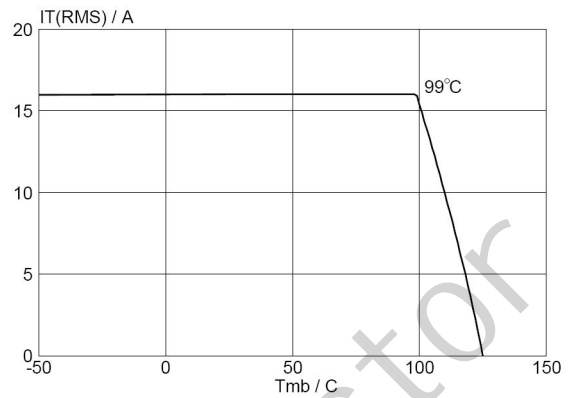
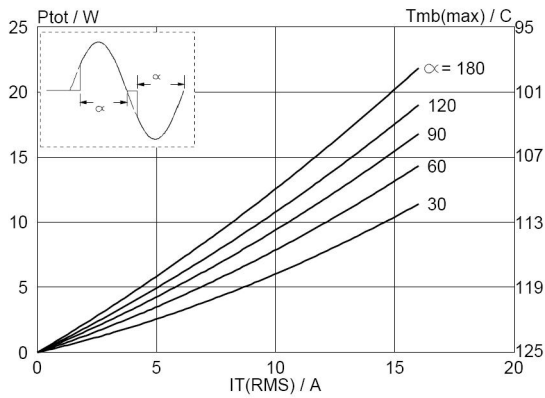
参数 Parameter	符号 Symbol	测试条件 Test Conditions	最小值 Min	典型值 Typ	最大值 Max	单位 Unit	
Gate trigger current	$I_{GT}$	$V_D=12V$ $I_T=0.1A$	T2+G+		2.5	10	mA
			T2+G-		4	10	
			T2-G-		5	10	
			T2-G+		11	25	
Latching current	$I_L$	$V_D=12V$ $I_G=0.1A$	T2+G+			30	mA
			T2+G-			40	
			T2-G-			30	
			T2-G+			40	
Holding current	$I_H$	$V_D=12V$ $I_G=0.1A$			45	mA	
On-state voltage	$V_T$	$I_T=20A$		1.2	1.6	V	
Gate trigger voltage	$V_{GT}$	$V_D=12V$ $I_T=0.1A$		0.7	1.5	V	
		$V_D=400V$ $I_T=0.1A$ , $T_j=125^\circ C$	0.25	0.4			
Off-state leakage current	$I_D$	$V_D=V_{DRM(max)}$ $T_j=125^\circ C$		0.1	0.5	mA	
Critical rate of rise of off-state current	$t_{gt}$	$I_{TM}=20A$ $V_D=V_{DRM(max)}$ $I_G=0.1A$ $di_g/dt=5A/\mu s$		2.0		$\mu s$	
Repetitive peak off-state current	$dV_D/dt$	$V_{DM}=67\% V_{DRM(MAX)}$ $T_j=125^\circ C$		50		V/ $\mu s$	

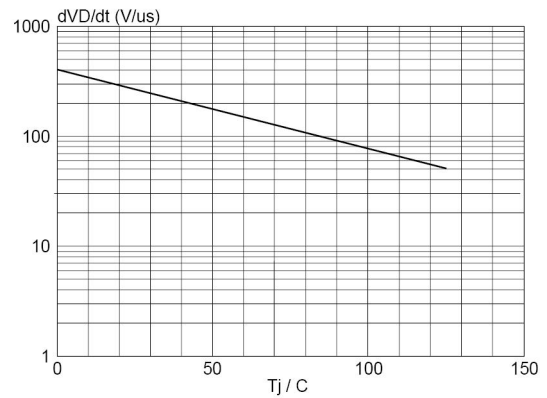
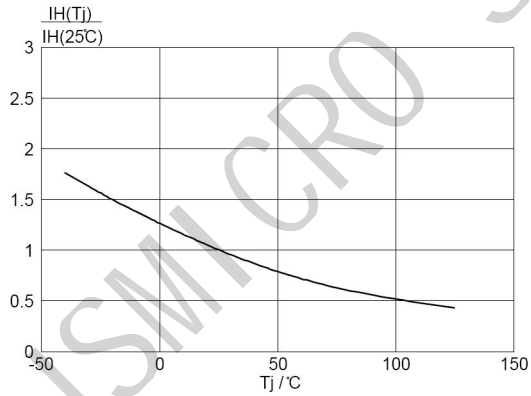
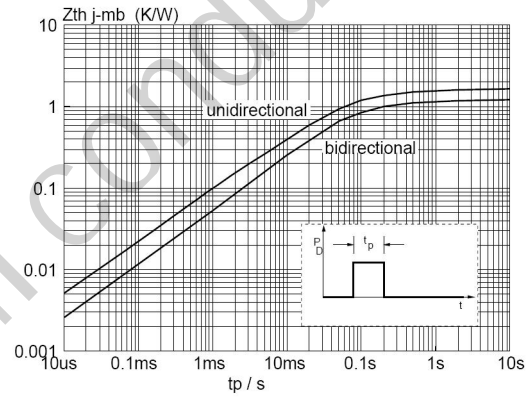
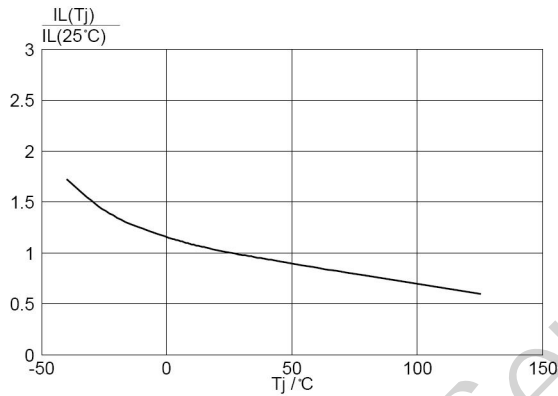
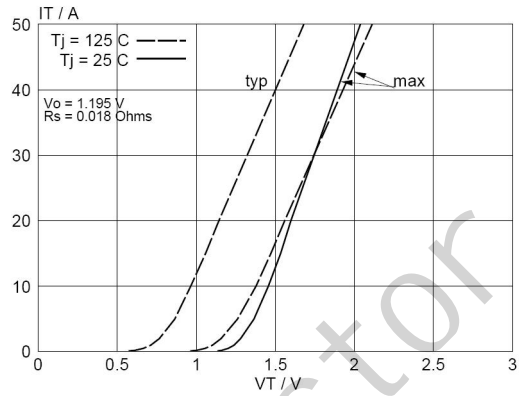
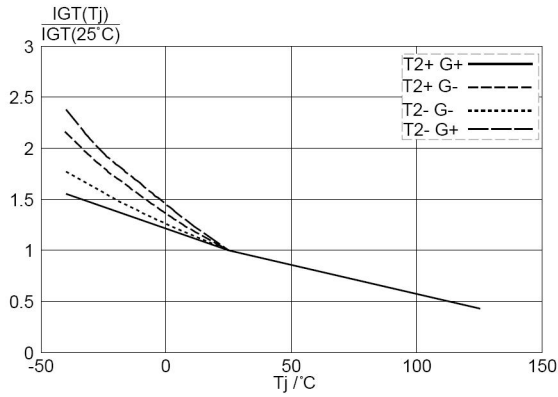
**电参数曲线图 / Electrical Characteristic Curve**

**电参数曲线图 / Electrical Characteristic Curve**

外形尺寸图 / Package Dimensions

TO-220

单位: mm

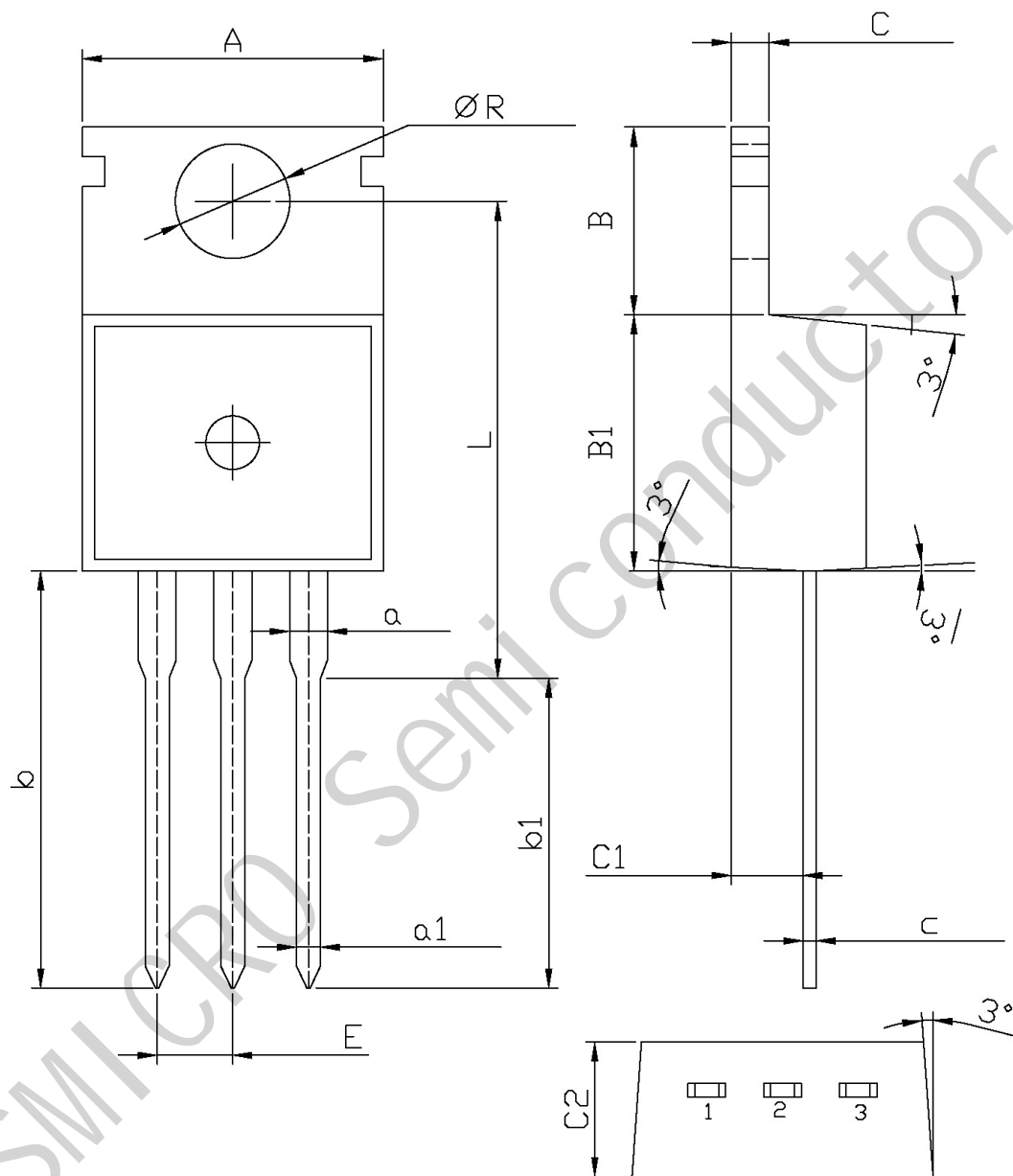

Symbol	Dimensions In Millimeters		Symbol	Dimensions In Millimeters	
	Min	Max		Min	Max
A	9.8	10.2	C	1.2	1.4
R	3.56	3.64	B	6.3	6.7
L	15.7	16.1	B1	9.0	9.4
b	12.6	13.6	C1	2.2	2.6
b1	9.6	10.6	a1	0.7	0.9
a	1.22	1.32	c	0.4	0.6
E	2.34	2.74	C2	4.3	4.7

## X-ON Electronics

Largest Supplier of Electrical and Electronic Components

*Click to view similar products for [Triacs](#) category:*

*Click to view products by [JSMSEMI](#) manufacturer:*

Other Similar products are found below :

[BT137-600-0Q](#) [2N6075A](#) [NTE5688](#) [D31410](#) [ACS102-5T1](#) [ACS102-5TA](#) [MAC97A4G](#) [Z0107MAG](#) [Z0107MARL1G](#) [Z0109MARLRPG](#)  
[BTA316-800ET,127](#) [BTA316-800CTQ](#) [ACTT8X-800CTNQ](#) [MCR22-6G](#) [BTA16-800B\(MS\)](#) [TYN1025RG-JSM](#) [BT138-600D](#) [BTA26-800BRG](#) [BT138-600E](#) [BTA24-600CWRG](#) [BTA16-800CWRG](#) [BT138-600E](#) [BTA08-800CW](#) [BTB24-800CW](#) [BTA16-800CW](#) [BTA16-600CW](#) [BT169](#) [MCR100-6U](#) [FT10050-12P](#) [BT151S-600R](#) [BT136-800E](#) [BT136S](#) [PCR606J](#) [CT404D-800S](#) [JST24A-800CW](#) [JST60IS-1600BW](#) [TYN810RG-JSM](#) [BT139B-600E-JSM](#) [TYN812RG-JSM](#) [BT152-800R](#) [BTB16-800BRG-JSM](#) [BTA20-800CRG TO-220](#) [BTA16-800BRG](#) [BTW69-1200RG](#) [TYN825RG-JSM](#) [BTA12-600CRG](#) [BT136-600E](#) [BTA12-600BRG](#) [BT139-600E](#) [BTA24-800CRG TO-220](#)