

FEATURES

- Fast switching
- 100% avalanche tested
- Improved dv/dt capability

APPLICATIONS

- Switch Mode Power Supply (SMPS)
- Uninterruptible Power Supply (UPS)
- Power Factor Correction (PFC)

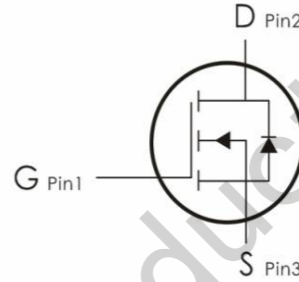
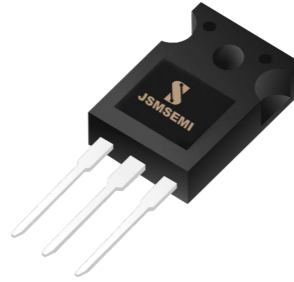

Device Marking and Package Information		
Device	Package	Marking
FDA70N20	TO-247	FDA70N20

Absolute Maximum Ratings $T_C = 25^\circ\text{C}$, unless otherwise noted			
Parameter	Symbol	Value	Unit
		TO-247	
Drain-Source Voltage ($V_{GS} = 0\text{V}$)	V_{DSS}	200	V
Continuous Drain Current $V_{GS} = 10\text{V}$ $T_C = 25^\circ\text{C}$	I_D	70	A
Pulsed Drain Current (note1)	I_{DM}	300	A
Gate-Source Voltage	V_{GSS}	± 20	V
Single Pulse Avalanche Energy (note2)	E_{AS}	1960.2	mJ
Avalanche Current (note1)	I_{AS}	19.8	A
Repetitive Avalanche Energy (note1)	E_{AR}	1176.1	mJ
Power Dissipation ($T_C = 25^\circ\text{C}$)	P_D	500	W
Peak Diode Recovery dv/dt (note1)	dv/dt	5.0	
Operating Junction and Storage Temperature Range	T_J, T_{stg}	-55~+150	$^\circ\text{C}$

Thermal Resistance			
Parameter	Symbol	Value	Unit
Thermal Resistance, Junction-to-Case	R_{thJC}	0.89	$^\circ\text{C/W}$
Thermal Resistance, Junction-to-Ambient	R_{thJA}	60	

Specifications $T_J = 25^\circ\text{C}$, unless otherwise noted						
Parameter	Symbol	Test Conditions	Value			Unit
			Min.	Typ.	Max.	
Static						
Drain-Source Breakdown Voltage	$V_{(BR)DSS}$	$V_{GS} = 0V, I_D = 250\mu A$	200	--	--	V
Zero Gate Voltage Drain Current	I_{DSS}	$V_{DS} = 40V, V_{GS} = 0V, T_J = 25^\circ\text{C}$	--	--	1	μA
		$V_{DS} = 32V, V_{GS} = 0V, T_J = 125^\circ\text{C}$	--	--	100	
Gate-Source Leakage	I_{GSS}	$V_{GS} = \pm 20V$	--	--	± 100	nA
Gate-Source Threshold Voltage	$V_{GS(th)}$	$V_{DS} = V_{GS}, I_D = 250\mu A$	2.0	--	4.0	V
Drain-Source On-Resistance (Note3)	$R_{DS(on)}$	$V_{GS} = 10V, I_D = 30A$	--	27	30	m Ω
Dynamic						
Input Capacitance	C_{iss}	$V_{GS} = 0V,$ $V_{DS} = 25V,$ $f = 1.0\text{MHz}$	--	5784	--	pF
Output Capacitance	C_{oss}		--	893	--	
Reverse Transfer Capacitance	C_{rss}		--	561	--	
Total Gate Charge	Q_g	$V_{DD} = 20V, I_D = 190A,$ $V_{GS} = 10V$	--	367	--	nC
Gate-Source Charge	Q_{gs}		--	33.8	--	
Gate-Drain Charge	Q_{gd}		--	177	--	
Turn-on Delay Time	$t_{d(on)}$	$V_{DD} = 20V, I_D = 190A,$ $R_G = 10\Omega, V_{GS} = 10V$	--	55	--	ns
Turn-on Rise Time	t_r		--	165	--	
Turn-off Delay Time	$t_{d(off)}$		--	1050	--	
Turn-off Fall Time	t_f		--	367	--	
Drain-Source Body Diode Characteristics						
Continuous Body Diode Current	I_S	$T_C = 25^\circ\text{C}$	--	--	70	A
Pulsed Diode Forward Current	I_{SM}		--	--	300	
Body Diode Voltage	V_{SD}	$T_J = 25^\circ\text{C}, I_{SD} = 95A, V_{GS} = 0V$	--	--	1.4	V
Reverse Recovery Time	t_{rr}	$V_{GS} = 0V, I_S = 190A,$ $di_F/dt = 100A/\mu s$	--	360	--	ns
Reverse Recovery Charge	Q_{rr}		--	5.61	--	μC

Notes

1. Repetitive Rating: Pulse width limited by maximum junction temperature
2. $L = 10\text{mH}, V_{DD} = 50V, R_G = 25\Omega$, Starting $T_J = 25^\circ\text{C}$
3. Pulse Test: Pulse width $\leq 300\mu s$, Duty Cycle $\leq 1\%$

Typical Characteristics $T_J = 25^\circ\text{C}$, unless otherwise noted

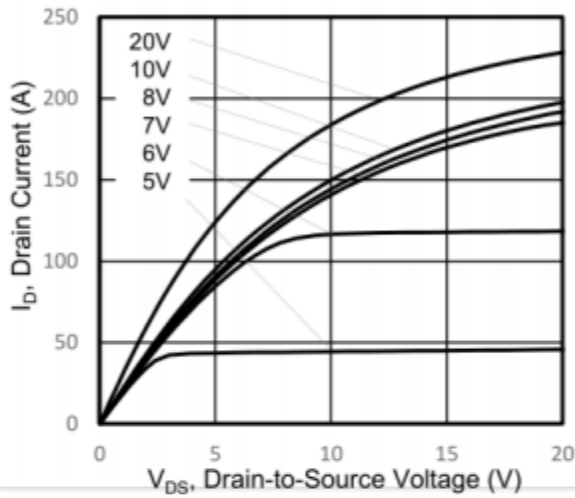
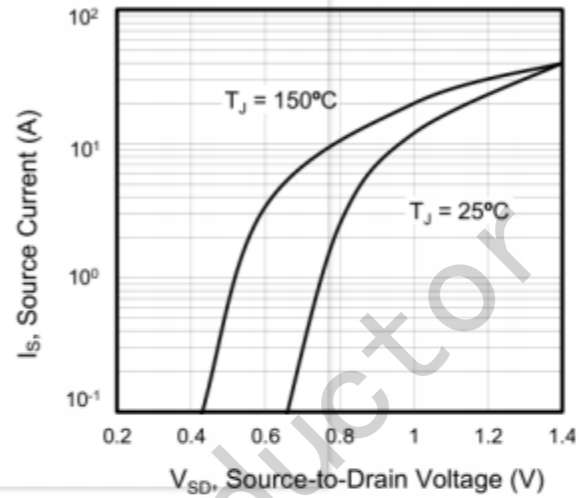
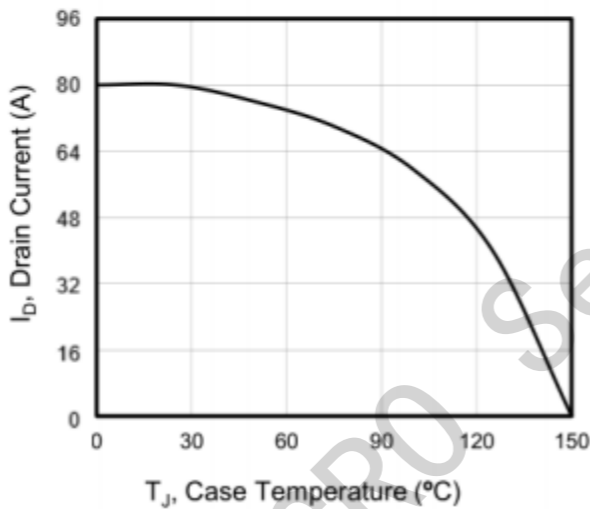
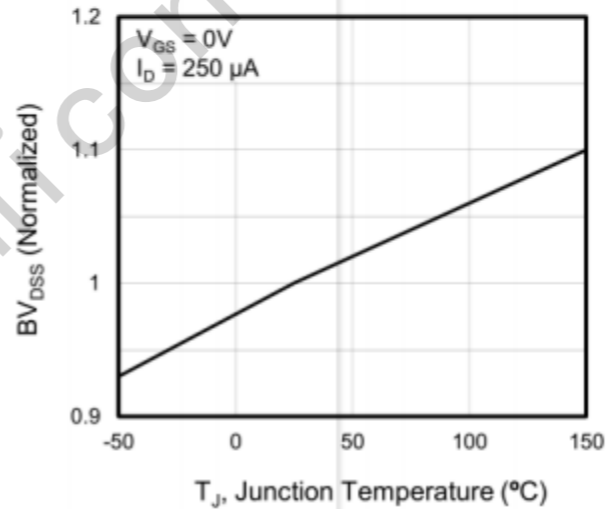
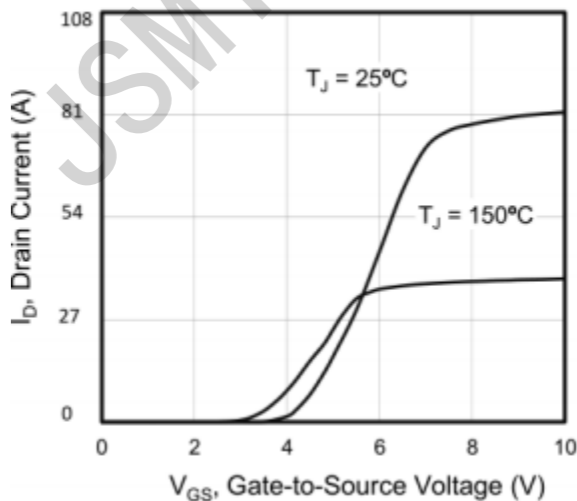
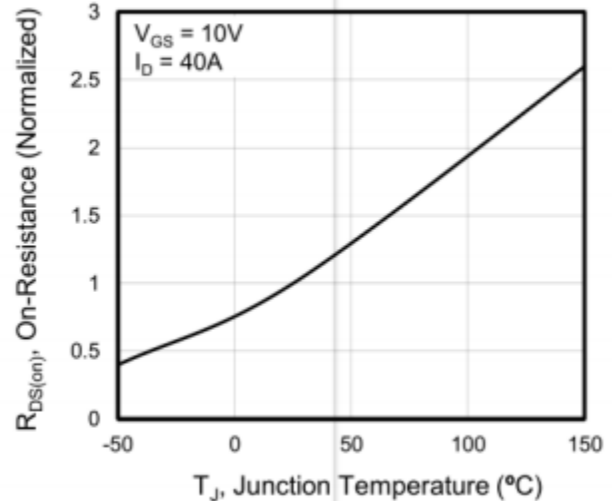
Figure 1. Output Characteristics ($T_J = 25^\circ\text{C}$)

Figure 2. Body Diode Forward Voltage

Figure 3. Drain Current vs. Temperature

Figure 4. BV_{DSS} Variation vs. Temperature

Figure 5. Transfer Characteristics

Figure 6. On-Resistance vs. Temperature

Typical Characteristics $T_j = 25^\circ\text{C}$, unless otherwise noted

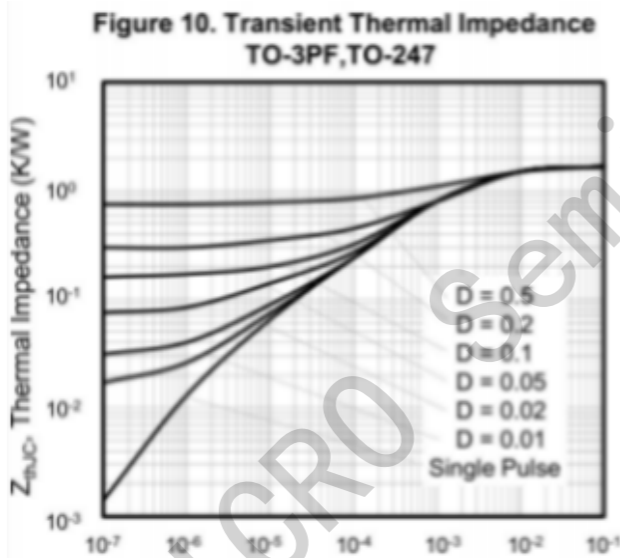
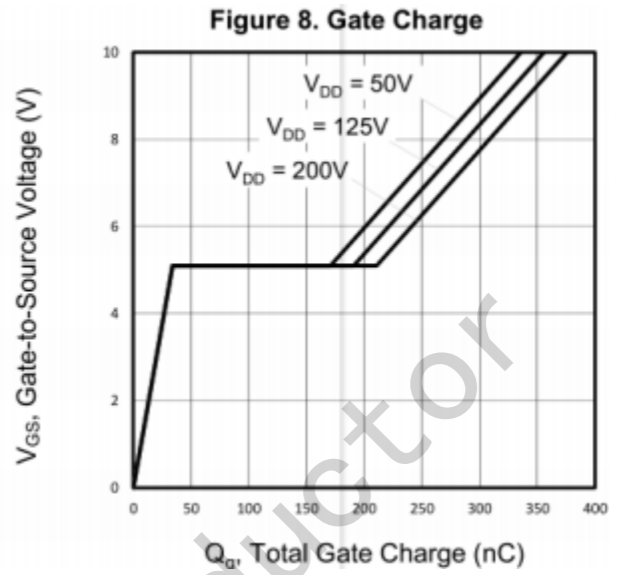

Figure A: Gate Charge Test Circuit and Waveform

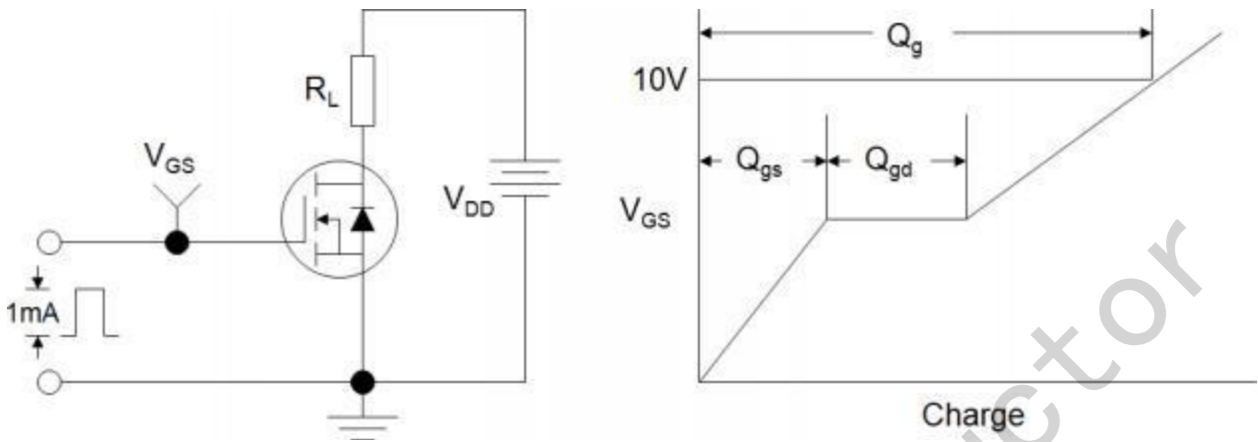

Figure B : Resistive Switching Test Circuit and Waveform

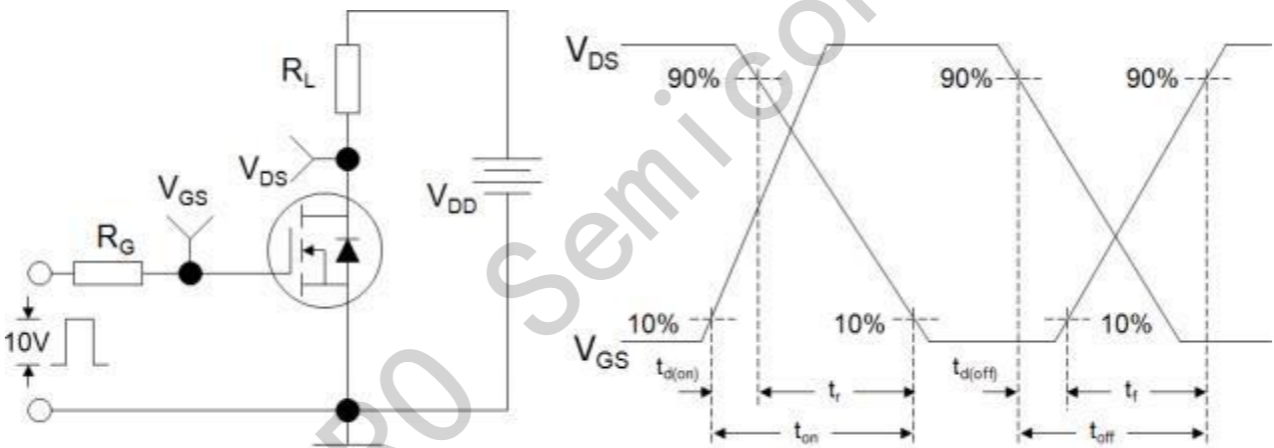
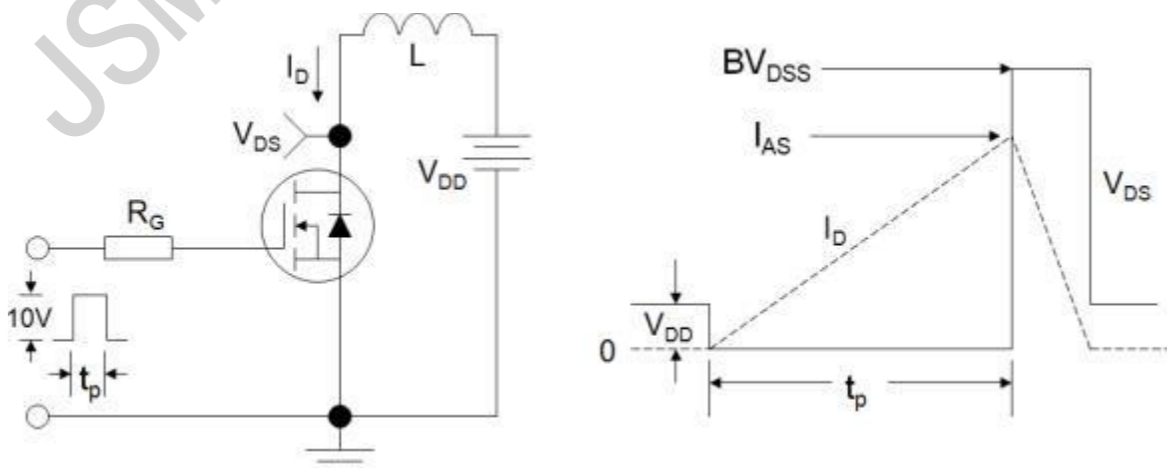
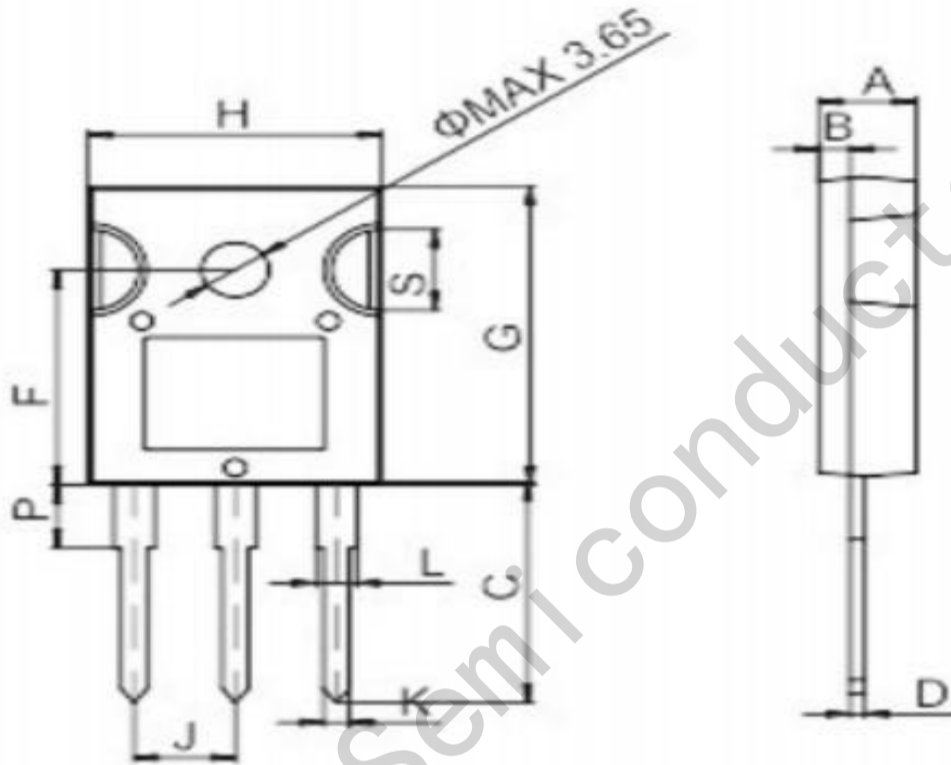

Figure C : Unclamped Inductive Switching Test Circuit and Waveform



TO-247



Ref.	Dimensions					
	Millimeters			Inches		
	Min.	Typ.	Max.	Min.	Typ.	Max.
A	4.9		5.4	0.193		0.213
B	1.6		2.0	0.063		0.079
C	14.35		15.4	0.565		0.606
D	0.5		0.8	0.020		0.031
F	14.4		15.1	0.567		0.594
G	19.7		20.6	0.775		0.811
H	15.4		16.2	0.606		0.638
J	5.3		5.6	0.209		0.220
K	1.3		1.5	0.051		0.059
L	2.8		3.3	0.110		0.130
P	3.7		4.2	0.146		0.165
S	5.35		5.65	0.211		0.222

X-ON Electronics

Largest Supplier of Electrical and Electronic Components

Click to view similar products for [MOSFET](#) category:

Click to view products by [JSMSEMI](#) manufacturer:

Other Similar products are found below :

[IRFD120](#) [JANTX2N5237](#) [BUK455-60A/B](#) [MIC4420CM-TR](#) [VN1206L](#) [NDP4060](#) [SI4482DY](#) [IPS70R2K0CEAKMA1](#) [SQD23N06-31L-GE3](#)
[TK16J60W,S1VQ\(O](#) [2SK2614\(TE16L1,Q\)](#) [DMN1017UCP3-7](#) [DMN1053UCP4-7](#) [SQJ469EP-T1-GE3](#) [NTE2384](#) [DMC2700UDMQ-7](#)
[DMN2080UCB4-7](#) [DMN61D9UWQ-13](#) [US6M2GTR](#) [DMN31D5UDJ-7](#) [DMP22D4UFO-7B](#) [DMN1006UCA6-7](#) [DMN16M9UCA6-7](#)
[STF5N65M6](#) [IRF40H233XTMA1](#) [STU5N65M6](#) [DMN6022SSD-13](#) [DMN13M9UCA6-7](#) [DMTH10H4M6SPS-13](#) [DMN2990UFB-7B](#)
[IPB80P04P405ATMA2](#) [2N7002W-G](#) [MCAC30N06Y-TP](#) [MCQ7328-TP](#) [BXP7N65D](#) [BXP4N65F](#) [AOL1454G](#) [WMJ80N60C4](#) [BXP2N20L](#)
[BXP2N65D](#) [BXT1150N10J](#) [BXT1700P06M](#) [TSM60NB380CP ROG](#) [RQ7L055BGTCR](#) [DMNH15H110SK3-13](#) [SLF10N65ABV2](#)
[BSO203SP](#) [BSO211P](#) [IPA60R230P6](#) [IPA60R460CE](#)