

FEATURES

- Fast switching
- 100% avalanche tested
- Improved dv/dt capability

APPLICATIONS

- DC-DC Converters
- DC-AC Inverters for UPS
- SMPS and Motor controls

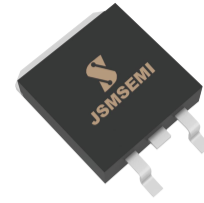

TO-263-2L

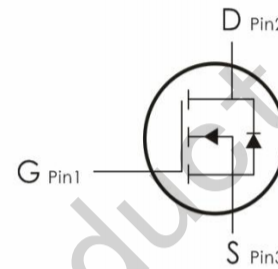

Device Marking and Package Information		
Device	Package	Marking
FDB33N25TM	TO-263-2L	FDB33N25

Absolute Maximum Ratings $T_C = 25^\circ\text{C}$, unless otherwise noted			
Parameter	Symbol	Value	Unit
Drain-Source Voltage	V_{DSS}	250	V
Continuous Drain Current	I_D	35	A
Pulsed Drain Current (note1)	I_{DM}	160	A
Gate-Source Voltage	V_{GSS}	± 20	V
Single Pulse Avalanche Energy (note1)	E_{AS}	191	mJ
Avalanche Current (note1)	I_{AS}	31	A
Repetitive Avalanche Energy (note1)	E_{AR}	124	mJ
Power Dissipation ($T_C = 25^\circ\text{C}$)	P_D	250	W
Operating Junction and Storage Temperature Range	T_J, T_{stg}	-55~+150	$^\circ\text{C}$

Thermal Resistance			
Parameter	Symbol	Value	Unit
Thermal Resistance, Junction-to-Case	R_{thJC}	1.2	$^\circ\text{C/W}$
Thermal Resistance, Junction-to-Ambient	R_{thJA}	60	

Specifications $T_J = 25^\circ\text{C}$, unless otherwise noted						
Parameter	Symbol	Test Conditions	Value			Unit
			Min.	Typ.	Max.	
Static						
Drain-Source Breakdown Voltage	$V_{(BR)DSS}$	$V_{GS} = 0V, I_D = 250\mu A$	250	--	--	V
Zero Gate Voltage Drain Current	I_{DSS}	$V_{DS} = 250V, V_{GS} = 0V, T_J = 25^\circ\text{C}$	--	--	1	μA
		$V_{DS} = 250V, V_{GS} = 0V, T_J = 125^\circ\text{C}$	--	--	100	
Gate-Source Leakage	I_{GSS}	$V_{GS} = \pm 20V, V_{DS} = 0V$	--	--	± 100	nA
Gate-Source Threshold Voltage	$V_{GS(th)}$	$V_{DS} = V_{GS}, I_D = 250\mu A$	2.0	--	4.0	V
Drain-Source On-Resistance (Note4)	$R_{DS(on)}$	$V_{GS} = 10V, I_D = 20A$	--	0.05	0.06	Ω
Forward Transconductance (Note4)	gfs	$V_{DS} = 25V, I_D = 20A$	--	16	--	S
Dynamic						
Input Capacitance	C_{iss}	$V_{GS} = 0V, V_{DS} = 25V, f = 1.0\text{MHz}$	--	2800	--	μF
Output Capacitance	C_{oss}		--	355	--	
Reverse Transfer Capacitance	C_{rss}		--	101	--	
Total Gate Charge	Q_g	$V_{DD} = 160V, I_D = 40A,$	--	154	--	nC
Gate-Source Charge	Q_{gs}		--	13	--	
Gate-Drain Charge	Q_{gd}		--	58	--	
Turn-on Delay Time	$t_{d(on)}$	$V_{DD} = 160V, I_D = 40A, V_{GS} = 15V, R_G = 25\Omega$	--	46	--	ns
Turn-on Rise Time	t_r		--	54	--	
Turn-off Delay Time	$t_{d(off)}$		--	360	--	
Turn-off Fall Time	t_f		--	96	--	
Drain-Source Body Diode Characteristics						
Continuous Source Current	I_{SD}	Integral PN-diode in MOSFET	--	--	35	A
Pulsed Source Current	I_{SM}		--	--	160	
Body Forward Voltage	V_{SD}	$I_S = 20A, V_{GS} = 0V$	--	--	1.4	V
Reverse Recovery Time	t_{rr}	$V_{GS} = 0V, I_F = 10A, di_F/dt = 100A/\mu s$	--	152	--	ns
Reverse Recovery Charge	Q_{rr}		--	1	--	μC

Notes:

1. Repetitive Rating: Pulse width limited by maximum junction temperature
2. $L = 1\text{mH}, V_{DD} = 30V, R_G = 25\Omega$, Starting $T_J = 25^\circ\text{C}$
3. Pulse Test: Pulse width $\leq 300\mu s$, Duty Cycle $\leq 1\%$

Typical Characteristics $T_J = 25^\circ\text{C}$, unless otherwise noted

Figure 1. Output Characteristics ($T_J = 25^\circ\text{C}$)

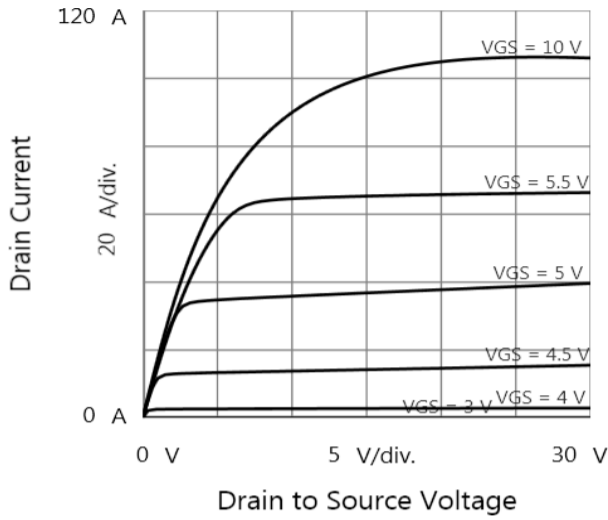

Figure 2. Transfer Characteristics

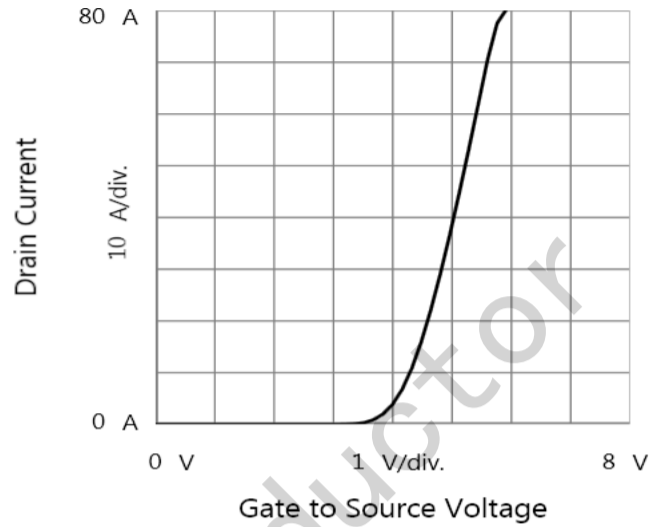

Figure 3. Drain to Source Resistance vs. Drain Current

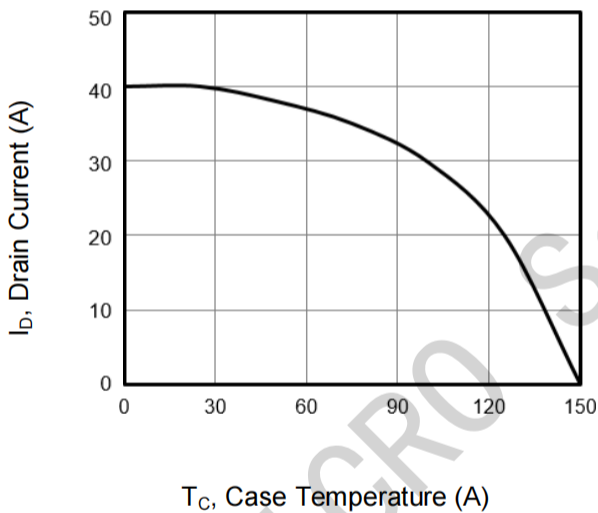

Figure 4. BV_{DSS} Variation vs. Temperature

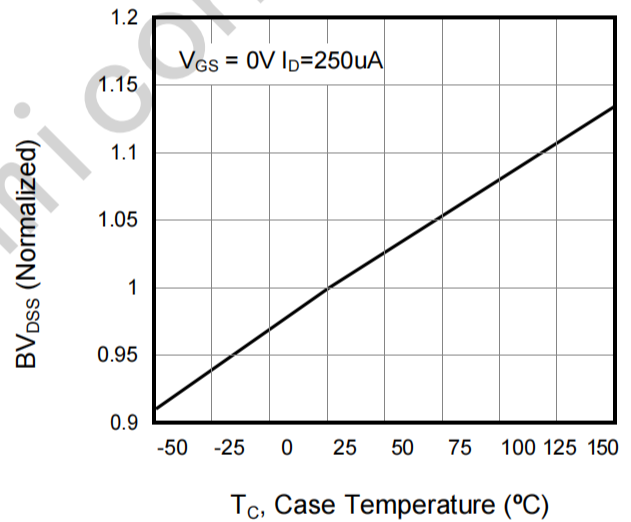

Figure 5. Drain to Source Voltage vs. Gate to Source Voltage

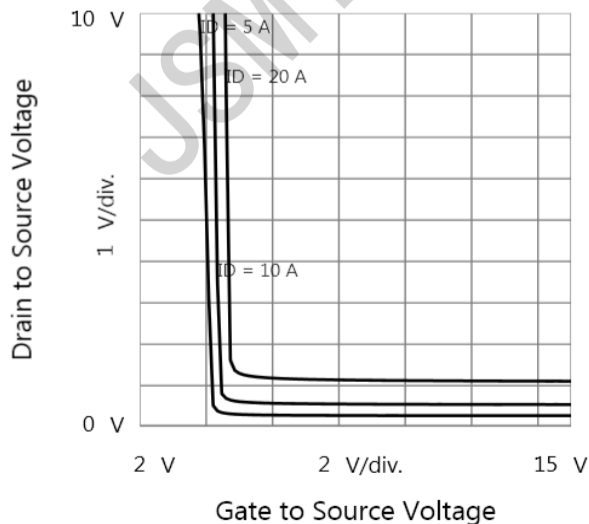
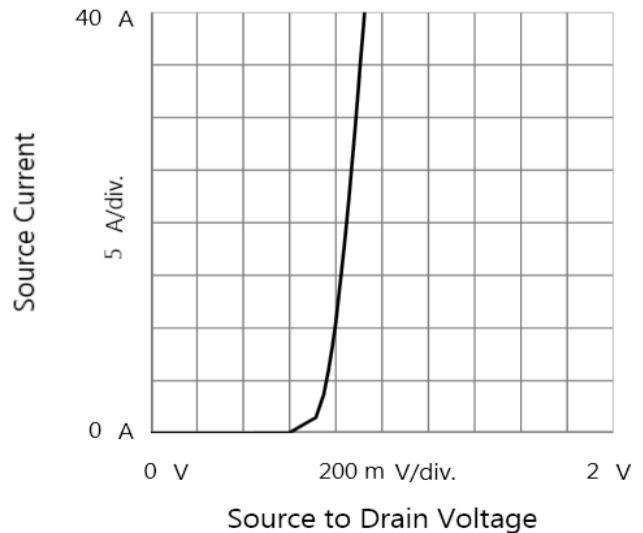

Figure 6. Body Diode Forward Characteristics



Typical Characteristics $T_J = 25^\circ\text{C}$, unless otherwise noted

Figure 7. Capacitance

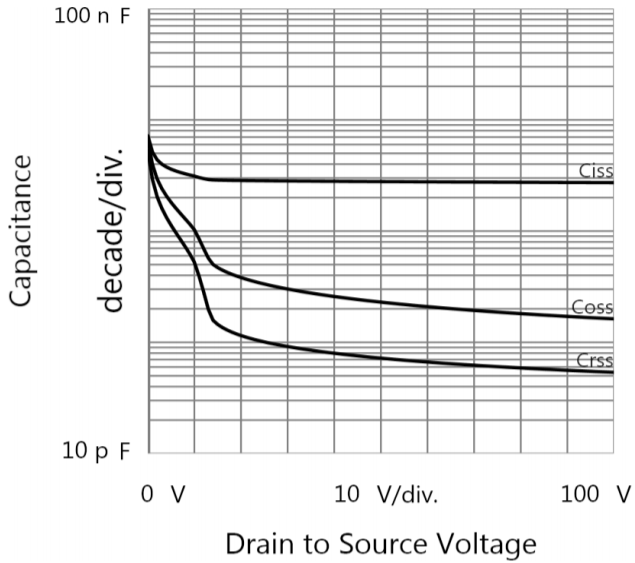

Figure 8. Gate Charge

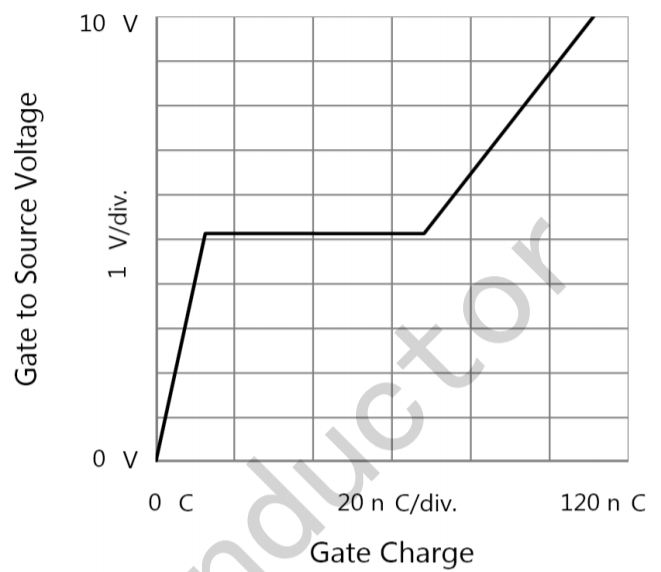

Figure 9. Transient Thermal Impedance

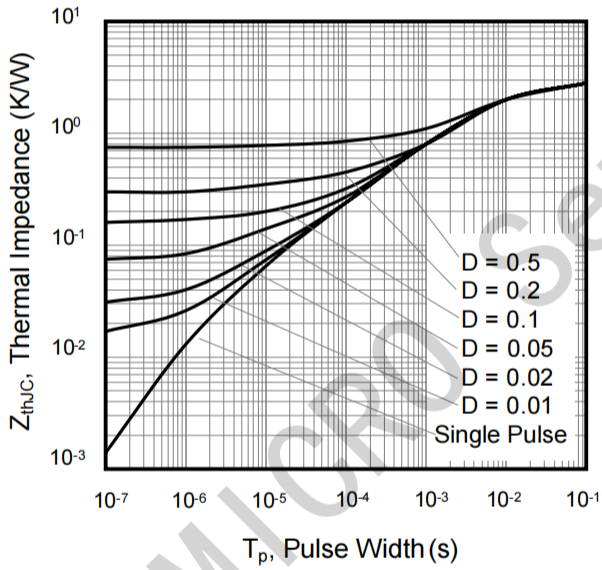

Figure A: Gate Charge Test Circuit and Waveform

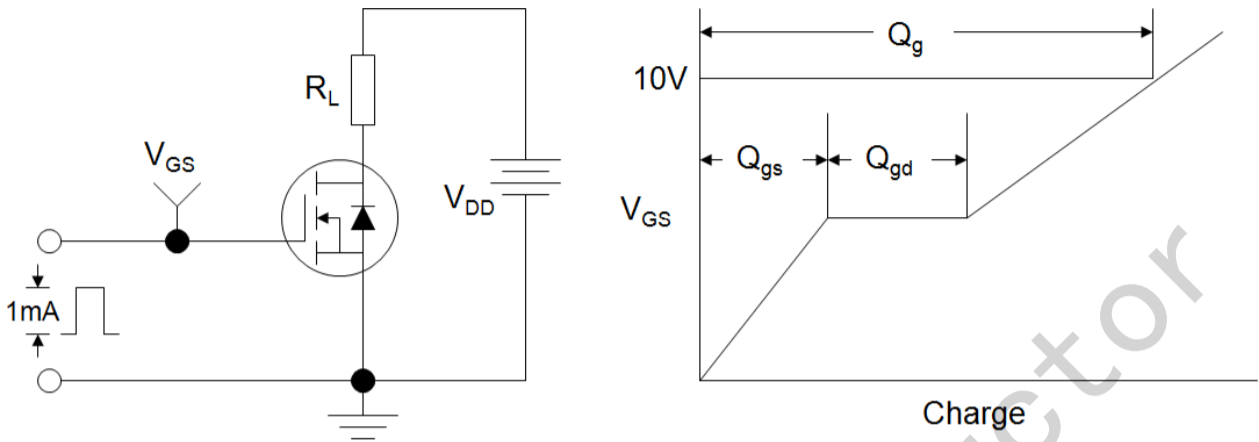

Figure B: Resistive Switching Test Circuit and Waveform

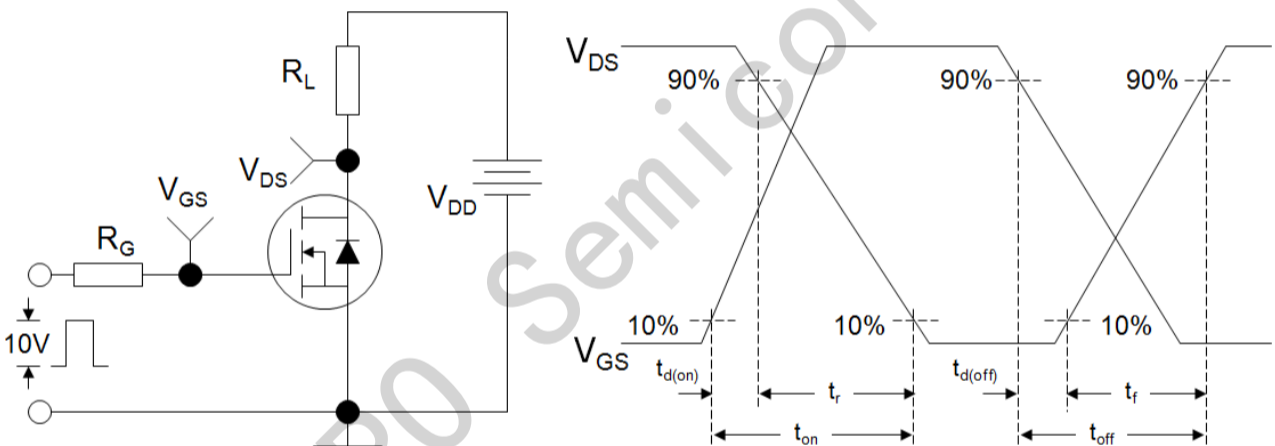
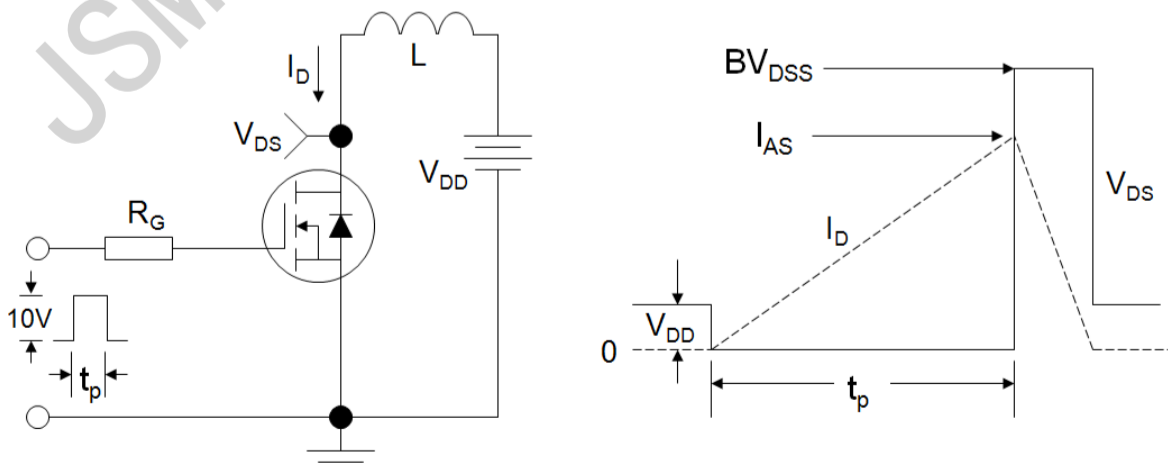
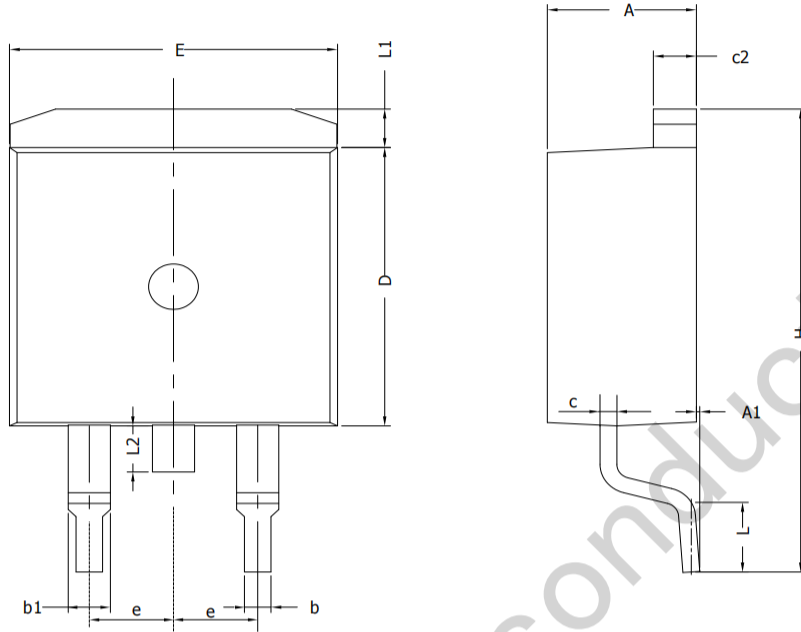

Figure C: Unclamped Inductive Switching Test Circuit and Waveform



Package Outline: TO-263



SYMBOL	MIN	NOM	MAX
A	4.30	4.57	4.72
A1	0	0.10	0.25
b	0.71	0.81	0.91
c	0.30	---	0.60
c2	1.17	1.27	1.37
D	8.50	---	9.35
E	9.80	---	10.45
e	2.54BSC		
H	14.70	---	15.75
L	2.00	2.30	2.74
L1	1.12	1.27	1.42
L2	---	---	1.75

X-ON Electronics

Largest Supplier of Electrical and Electronic Components

Click to view similar products for [MOSFET](#) category:

Click to view products by [JSMSEMI](#) manufacturer:

Other Similar products are found below :

[IRFD120](#) [JANTX2N5237](#) [BUK455-60A/B](#) [MIC4420CM-TR](#) [VN1206L](#) [NDP4060](#) [SI4482DY](#) [IPS70R2K0CEAKMA1](#) [SQD23N06-31L-GE3](#)
[TK16J60W,S1VQ\(O](#) [2SK2614\(TE16L1,Q\)](#) [DMN1017UCP3-7](#) [DMN1053UCP4-7](#) [SQJ469EP-T1-GE3](#) [NTE2384](#) [DMC2700UDMQ-7](#)
[DMN2080UCB4-7](#) [DMN61D9UWQ-13](#) [US6M2GTR](#) [DMN31D5UDJ-7](#) [DMP22D4UFO-7B](#) [DMN1006UCA6-7](#) [DMN16M9UCA6-7](#)
[STF5N65M6](#) [IRF40H233XTMA1](#) [STU5N65M6](#) [DMN6022SSD-13](#) [DMN13M9UCA6-7](#) [DMTH10H4M6SPS-13](#) [DMN2990UFB-7B](#)
[IPB80P04P405ATMA2](#) [2N7002W-G](#) [MCAC30N06Y-TP](#) [MCQ7328-TP](#) [BXP7N65D](#) [BXP4N65F](#) [AOL1454G](#) [WMJ80N60C4](#) [BXP2N20L](#)
[BXP2N65D](#) [BXT1150N10J](#) [BXT1700P06M](#) [TSM60NB380CP](#) [ROG](#) [RQ7L055BGTCR](#) [DMNH15H110SK3-13](#) [SLF10N65ABV2](#)
[BSO203SP](#) [BSO211P](#) [IPA60R230P6](#) [IPA60R460CE](#)