

概述 Description

H11L1 系列器件具备 GaAs 红外发射二极管，该二极管光学耦合到高速集成电路探测器。输出探测器包含施密特触发器，为噪声免疫和脉冲整形提供了滞后效应。

特性 Features

- 高数据速率，典型频率为 2MHZ(NRZ)
- 在整个电压和温度范围内无门锁和振荡
- 兼容微处理器的驱动器
- 输出在 0.4V 条件下的最大灌电流为：16mA
- 保证导通/关断阈值滞后
- 宽电源电压能力，兼容常见的逻辑电平
- 温度范围：-55°C ~ 100°C
- 紧凑型双列直插式封装

应用 Applications

- 逻辑到逻辑隔离器
- 可编程电流电平传感器
- 线路接收机-消除噪声和瞬态问题
- AC 到 TTL 的转换-方波整形
- 电源数字化编程

真值表 Truth table

LED	VO
H	L
L	H

封装和原理图

Package and Schematic Diagram

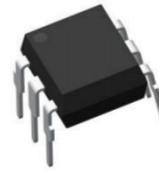

DIP6
H11L1



SMD6
H11L1S

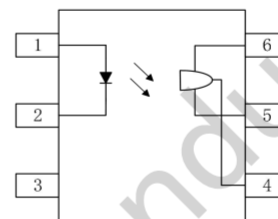

Pin Configuration

1. Anode
2. Cathode
3. NC
4. VO
5. GND
6. VCC

绝缘和安规信息 Insulation and Safety related specifications

项目 Item	符号 Symbol	数值 Value	单位 Unit	备注 Remark
爬电距离 Creepage Distance	L	≥7.6	mm	从输入端到输出端, 沿本体最短距离路径 Measured from input terminals to output terminals, shortest distance path along body
电气间隙 Clearance Distance	L	≥7.6	mm	从输入端到输出端, 通过空气的最短距离 Measured from input terminals to output terminals, shortest distance through air
绝缘距离 Insulation Thickness	DTI	≥0.4	mm	发射器和探测器之间的绝缘厚度 Insulation thickness between emitter and detector
峰值隔离电压 Peak Isolation Voltage	V_{IORM}	1500	V_{peak}	
瞬态隔离电压 Transient isolation voltage	V_{IOTM}	7000	V_{peak}	
隔离电压 Isolation Voltage	V_{iso}	> 5000	V_{rms}	For 1 min

极限参数 Absolute Maximum Ratings (Ta=25°C)

参数 Parameter		符号 Symbol	额定值 Rating	单位 Unit
输入 Input	正向电流 Forward Current	I_F	60	mA
	反向电压 Reverse Voltage	V_R	6	V
	功耗 Power Dissipation	P_D	120	mW
输出 Output	V45 允许范围 V45 Allowed Range	V_O	0-16	V
	V65 允许范围 V65 Allowed Range	V_{CC}	3-16	V
	输出电流 Output Current	I_O	50	mA
	功耗 power dissipation	P_D	150	mW
总功耗 Total Power Dissipation		P_{tot}	250	mW
隔离电压 Isolation Voltage		V_{iso}	5000	V_{rms}
工作温度 Operating Temperature		T_{opr}	-55~+100	°C
储存温度 Storage Temperature		T_{stg}	-55~+125	°C
焊接温度 (10s) Soldering Temperature (10s)		T_{sol}	260	°C

产品特性参数 Electro-optical Characteristics (Ta=25°C)

参数 Parameter		符号 Symbol	条件 Condition	最小 Min.	典型 Typ.	最大 Max.	单位 Unit	
输入 Input	正向电压 Forward Voltage	V_F	$I_F=10\text{mA}$	-	1.24	1.5	V	
	反向电流 Reverse Current	I_R	$V_R=5\text{V}$	-	-	10	μA	
	输入电容 Input capacitance	C_J	$V=0, f=1\text{MHz}$	-	-	100	pF	
输出 Output	电压运行范围 Operation Voltage Range	V_{CC}		3	-	15	V	
	电源电流 Supply Current	$I_{CC(\text{off})}$	$I_F=0\text{mA}, V_{CC}=5\text{V}$		0.62	1.5	mA	
	高输出电流 Output Current, High	I_{OH}	$I_F=0\text{mA}, V_{CC}=V_O=15\text{V}$	-	-	100	μA	
	隔离电阻 Isolation Resistance	R_{ISO}	$V_{I-O}=500\text{VDC}$	10^{11}	-	-	Ω	
传输特性 Transfer Characteristics	电源电流 Supply Current	$I_{CC(\text{on})}$	$I_F=10\text{mA}, V_{CC}=5\text{V}$	-	0.67	1.5	mA	
	低输出电压 Output Voltage .low	V_{OL}	$V_{CC}=5\text{V}, I_F=I_{Fon(\text{max})}$ $R_L=270\Omega$	-	-	0.4	V	
	开启阈值电流 Turn onThreshold Current	HZH11L1	I_{Fon}	$V_{CC}=5\text{V}, R_L=270\Omega$	-	-	1.6	mA
		HZH11L2			-	-	10	
		HZH11L3			-	-	5	
	滞后比 Hysteresis Ratio	I_{Foff}/I_{Fon}	$V_{CC}=5\text{V}, R_L=270\Omega$	0.5	-	0.9		
	开启时间 Turn on Time	t_{on}	$V_{CC}=5\text{V}, I_F=I_{Fon},$ $R_L=270\Omega$	-	-	4	μs	
	下降时间 Fall Time	t_f		-	0.1	-	μs	
	关闭时间 Turn off Time	t_{off}		-	-	4	μs	
	上升时间 Rise Time	t_r		-	0.1	-	μs	
数据速率 Data Rate			-	2	-	MHz		

典型光电特性曲线 Typical Electro-Optical Characteristics Curves

Fig.1 Forward current vs Forward Voltage

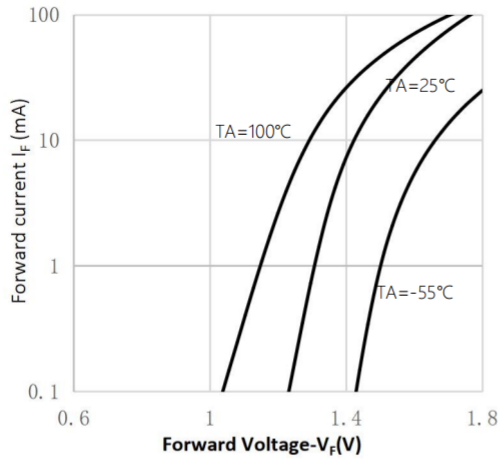

Fig.2 Transfer characteristic

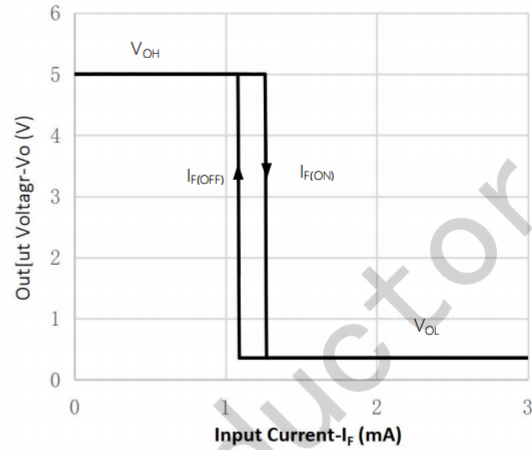

Fig.3 Turn On Threshold Current vs Supply Voltage

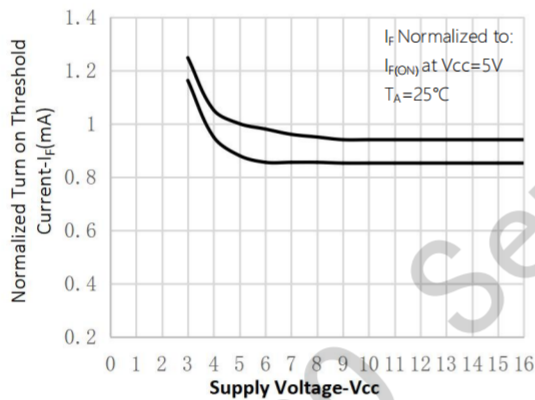

Fig.4 Turn On Threshold Current vs Ambient temperature

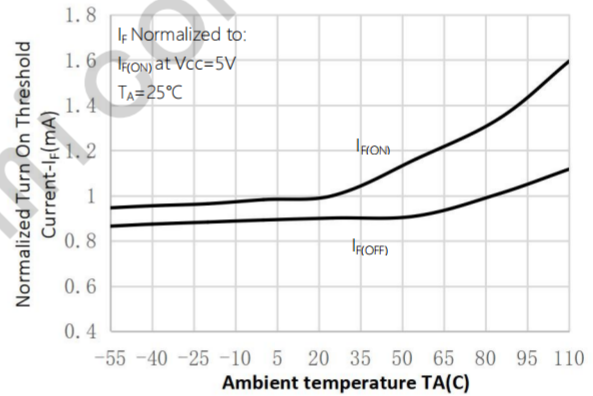

Fig.5 Low Level Output Voltage vs Load Current

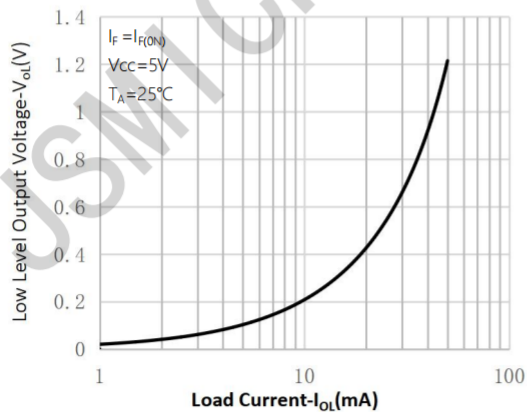
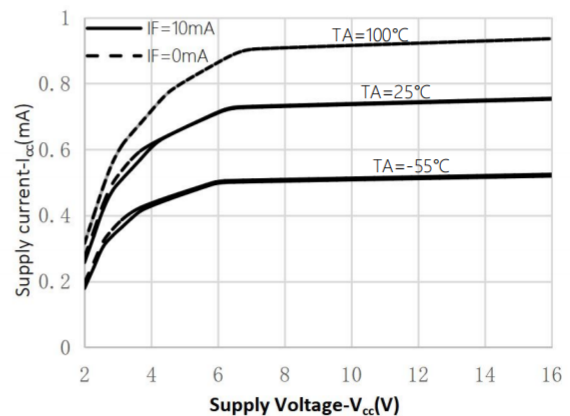
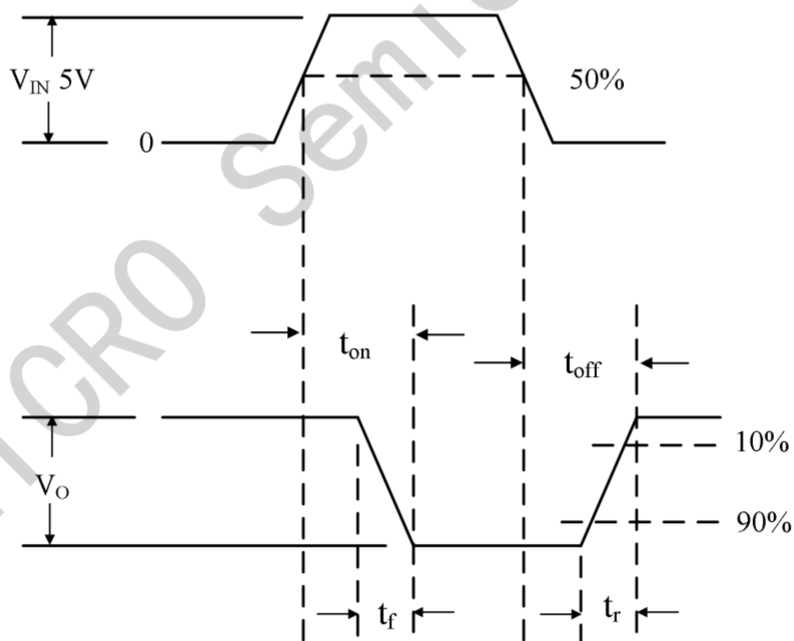
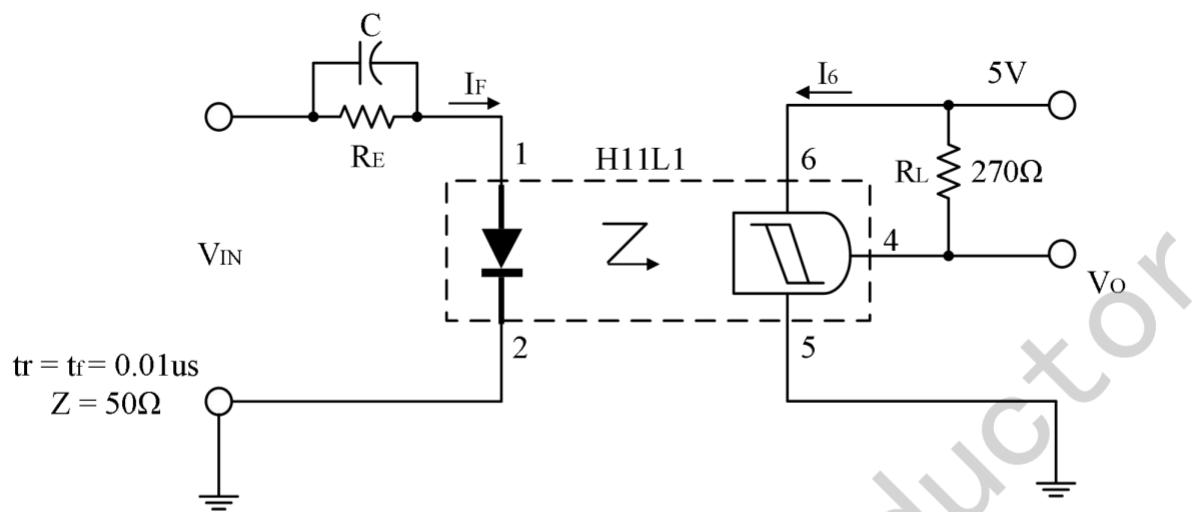

Fig.6 Supply current vs Supply Voltage



开关时间测试电路 Switching Time Test Circuit & Waveforms



外形尺寸 Outline Dimensions

DIP6

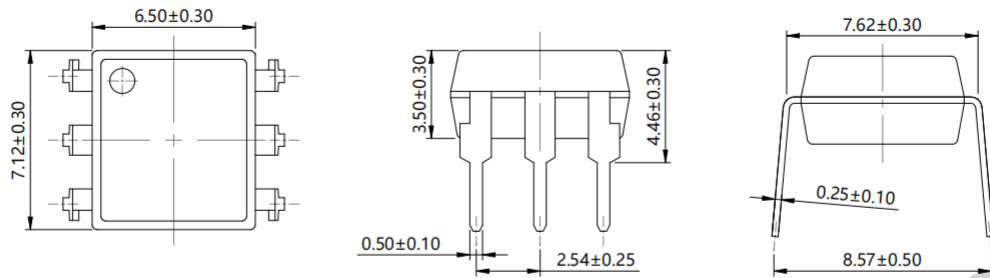

SMD6

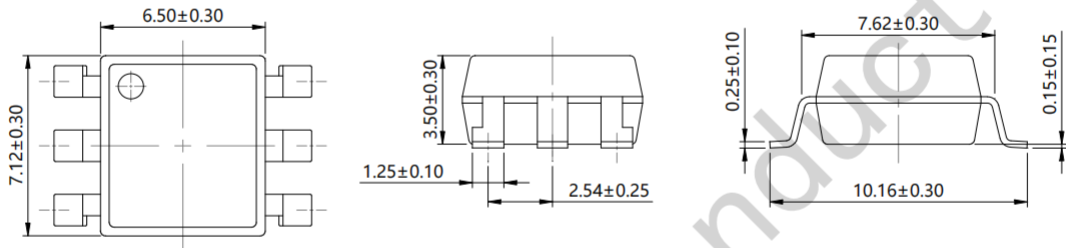

单位 Unit: mm

回流焊温度曲线图 Solder Reflow Profile

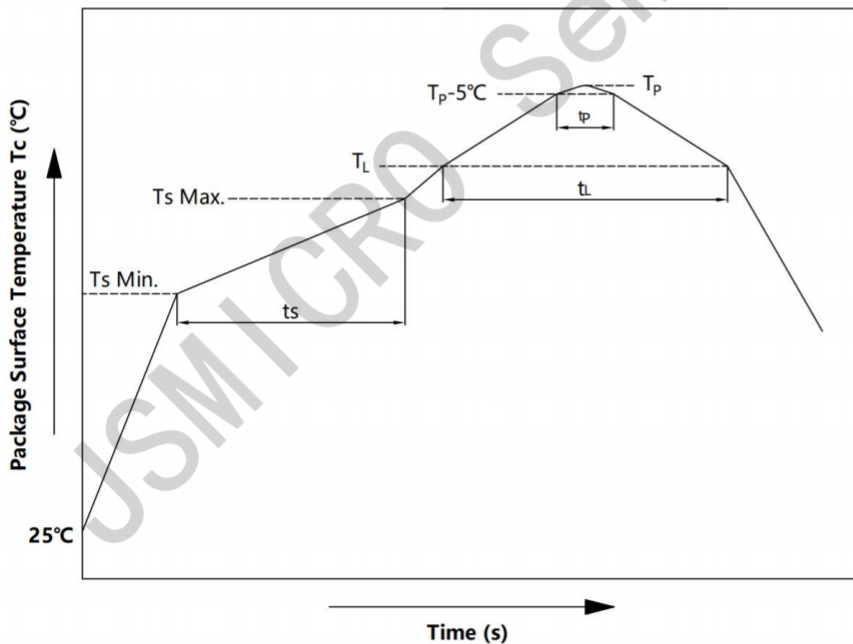

波峰焊温度曲线图 Wave Soldering Profile

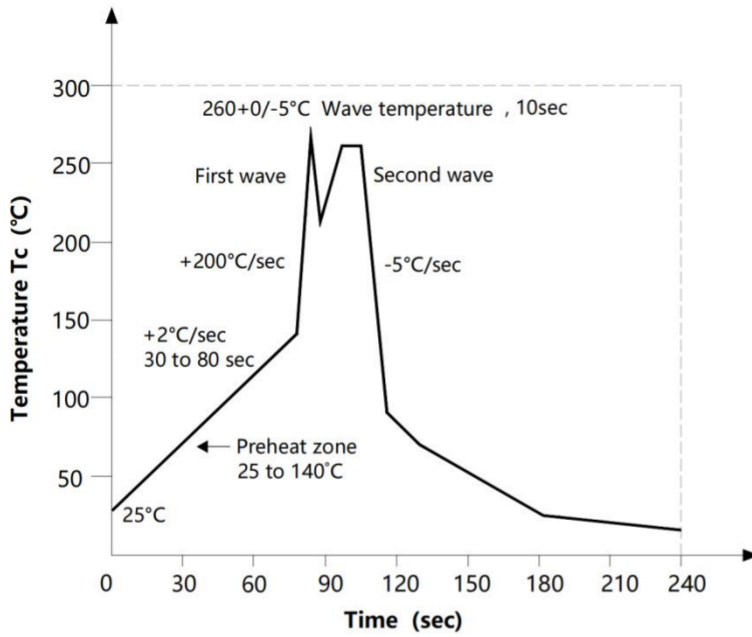

JSMICRO Semiconductor

X-ON Electronics

Largest Supplier of Electrical and Electronic Components

Click to view similar products for [Logic Output Opto-couplers](#) category:

Click to view products by [JSMSEMI](#) manufacturer:

Other Similar products are found below :

[CPC1590P](#) [FOD3150A](#) [TLP5214A\(E\(O](#) [FOD3125SD](#) [FOD8482T](#) [LTV-332J-TP1](#) [TLP719F\(D4-TP,F\)](#) [LTV-T350S-TA1](#) [PC925LEYIP0F](#)
[SL3120R](#) [H11L1-JSM](#) [6N137](#) [LTV-5314W-TP1](#) [H11L1S-JSM](#) [CY6N139](#) [CY6N137](#) [ICPL2611SM](#) [ELS3150P\(TA\)-VG](#) [OR-0631-TA1](#)
[ICPL2611SMT&R](#) [CYHCPL2630](#) [H11L1S\(TA\)](#) [H11L3SR2M](#) [HCPL-0302-000E](#) [HCPL-J312-000E](#) [LTV-3120S-TA1](#) [TLP155E\(TPL,E\)](#)
[TLP2345\(E\(T](#) [TLP2348\(E\(T](#) [TLP350H\(F\)](#) [TLP5214\(E\(O](#) [8302401EC](#) [TLP351H\(F\)](#) [TLP5214\(TP,E\(O](#) [TLP5702\(TP,E](#) [5962-8947701PA](#)
[ACPL-W343-500E](#) [TLP351H\(TP1,F\)](#) [FOD3120SDV](#) [FOD8160](#) [FOD3184TSR2V](#) [HCPL-6750](#) [TLP152\(TPL,E](#) [H11L1](#) [TLP250\(F\)](#)
[VO3150A-X017T](#) [FOD8342TR2V](#) [TLP5214A\(D4-TP,E](#) [FOD8314TR2V](#) [FOD8343TR2](#)