

## FEATURES

- Fast switching
- 100% avalanche tested
- Improved dv/dt capability

## APPLICATIONS

- Switch Mode Power Supply (SMPS)
- Uninterruptible Power Supply (UPS)
- Power Factor Correction (PFC)

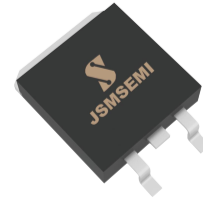

TO-263-2L

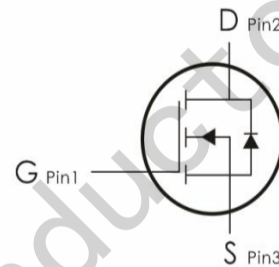

### Device Marking and Package Information

Device	Package	Marking
IPB26CN10N	TO-263	26CN10N

### Absolute Maximum Ratings $T_C = 25^\circ\text{C}$ , unless otherwise noted

Parameter	Symbol	Value	Unit
		TO-263	
Drain-Source Voltage ( $V_{GS} = 0\text{V}$ )	$V_{DSS}$	100	V
Continuous Drain Current	$I_D$	35	A
Pulsed Drain Current (note1)	$I_{DM}$	140	A
Gate-Source Voltage	$V_{GSS}$	$\pm 20$	V
Single Pulse Avalanche Energy (note2)	$E_{AS}$	335	mJ
Single Pulse Avalanche Current (note1)	$I_{AS}$	22	A
Repetitive Avalanche Energy (note1)	$E_{AR}$	201	mJ
Power Dissipation ( $T_C = 25^\circ\text{C}$ )	$P_D$	130	W
Operating Junction and Storage Temperature Range	$T_J, T_{stg}$	-55~+150	$^\circ\text{C}$

### Thermal Resistance

Parameter	Symbol	Value	Unit
		TO-263	
Thermal Resistance, Junction-to-Case	$R_{thJC}$	1.14	KW
Thermal Resistance, Junction-to-Ambient	$R_{thJA}$	60	

Specifications $T_J = 25^\circ\text{C}$ , unless otherwise noted						
Parameter	Symbol	Test Conditions	Value			Unit
			Min.	Typ.	Max.	
<b>Static</b>						
Drain-Source Breakdown Voltage	$V_{(BR)DSS}$	$V_{GS} = 0V, I_D = 250\mu A$	100	--	--	V
Zero Gate Voltage Drain Current	$I_{DSS}$	$V_{DS} = 100V, V_{GS} = 0V, T_J = 25^\circ\text{C}$	--	--	1	$\mu A$
		$V_{DS} = 80V, V_{GS} = 0V, T_J = 125^\circ\text{C}$	--	--	100	
Gate-Source Leakage	$I_{GSS}$	$V_{GS} = \pm 20V$	--	--	$\pm 100$	nA
Gate-Source Threshold Voltage	$V_{GS(th)}$	$V_{DS} = V_{GS}, I_D = 250\mu A$	2.0	--	4.0	V
Drain-Source On-Resistance (Note3)	$R_{DS(on)}$	$V_{GS} = 10V, I_D = 15A$	--	30	38	m $\Omega$
<b>Dynamic</b>						
Input Capacitance	$C_{iss}$	$V_{GS} = 0V,$ $V_{DS} = 25V,$ $f = 1.0\text{MHz}$	--	1331	--	pF
Output Capacitance	$C_{oss}$		--	276	--	
Reverse Transfer Capacitance	$C_{rss}$		--	88	--	
Total Gate Charge	$Q_g$	$V_{DD} = 80V, I_D = 30A,$ $V_{GS} = 10V$	--	53	--	nC
Gate-Source Charge	$Q_{gs}$		--	6	--	
Gate-Drain Charge	$Q_{gd}$		--	29	--	
Turn-on Delay Time	$t_{d(on)}$	$V_{DD} = 50V, I_D = 10A,$ $R_G = 25\Omega$	--	39	--	ns
Turn-on Rise Time	$t_r$		--	45	--	
Turn-off Delay Time	$t_{d(off)}$		--	207	--	
Turn-off Fall Time	$t_f$		--	64	--	
<b>Drain-Source Body Diode Characteristics</b>						
Continuous Body Diode Current	$I_S$	$T_C = 25^\circ\text{C}$	--	--	35	A
Pulsed Diode Forward Current	$I_{SM}$		--	--	140	
Body Diode Voltage	$V_{SD}$	$T_J = 25^\circ\text{C}, I_{SD} = 15A, V_{GS} = 0V$	--	--	2	V
Reverse Recovery Time	$t_{rr}$	$V_{GS} = 0V, I_S = 10A,$ $di_F/dt = 100A/\mu s$	--	102	--	ns
Reverse Recovery Charge	$Q_{rr}$		--	0.46	--	$\mu C$

**Notes**

1. Repetitive Rating: Pulse width limited by maximum junction temperature
2.  $L=1\text{mH}, V_{DD} = 50V, R_G = 25\Omega$ , Starting  $T_J = 25^\circ\text{C}$
3. Pulse Test: Pulse width  $\leq 300\mu s$ , Duty Cycle  $\leq 1\%$

**Typical Characteristics**  $T_J = 25^\circ\text{C}$ , unless otherwise noted

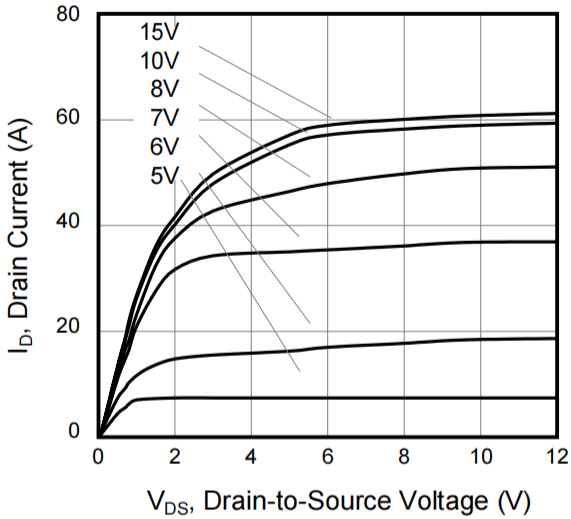
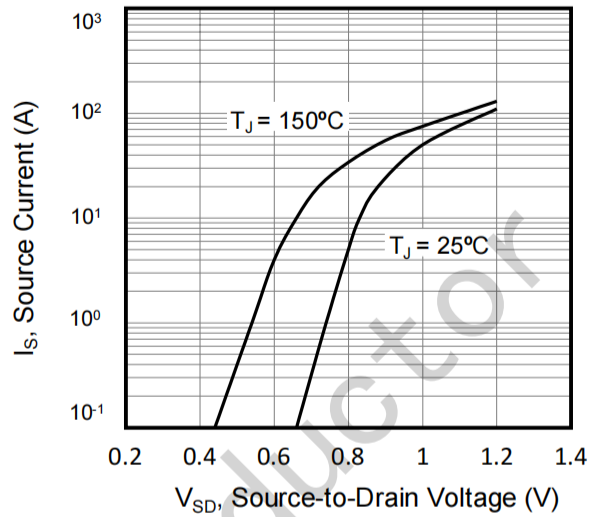
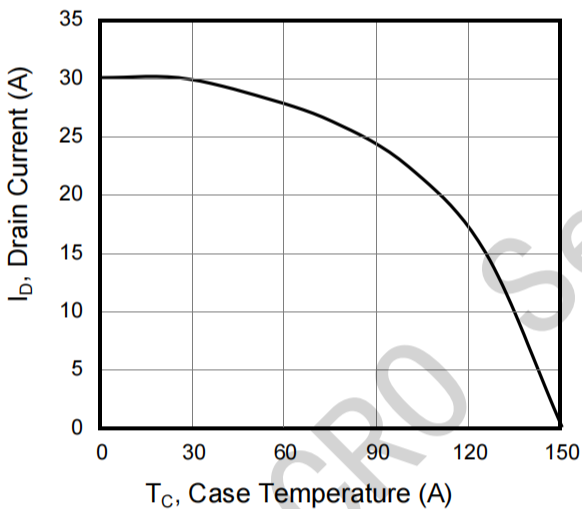
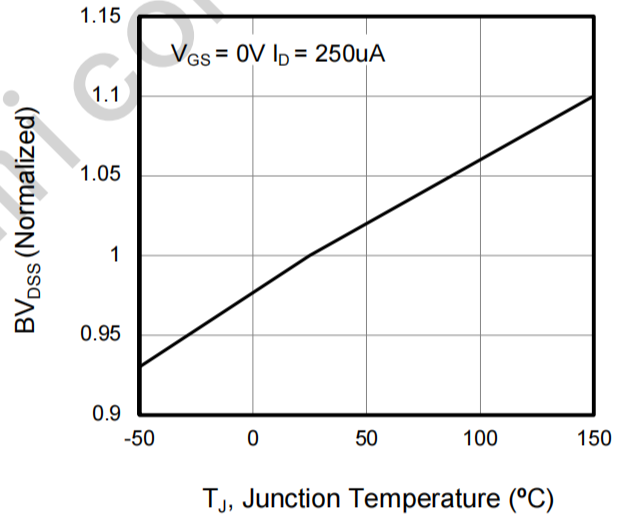
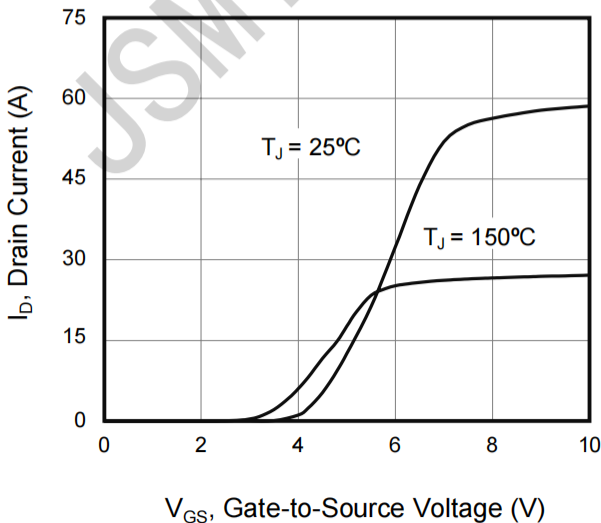
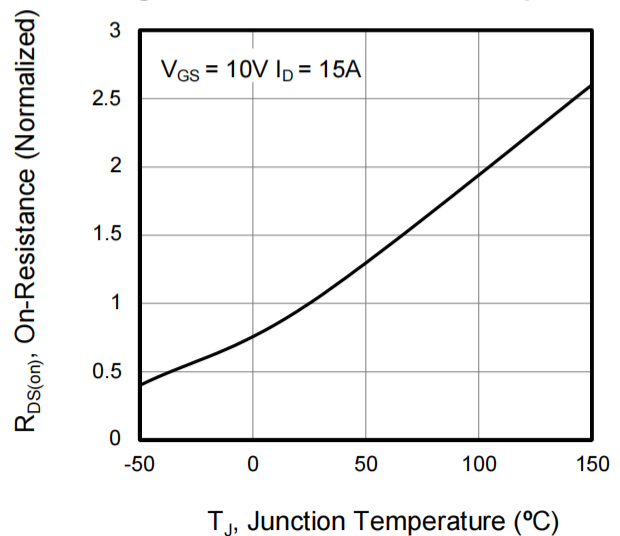
**Figure 1. Output Characteristics ( $T_J = 25^\circ\text{C}$ )**

**Figure 2. Body Diode Forward Voltage**

**Figure 3. Drain Current vs. Temperature**

**Figure 4.  $BV_{DSS}$  Variation vs. Temperature**

**Figure 5. Transfer Characteristics**

**Figure 6. On-Resistance vs. Temperature**

Typical Characteristics  $T_J = 25^\circ\text{C}$ , unless otherwise noted

Figure 7. Capacitance

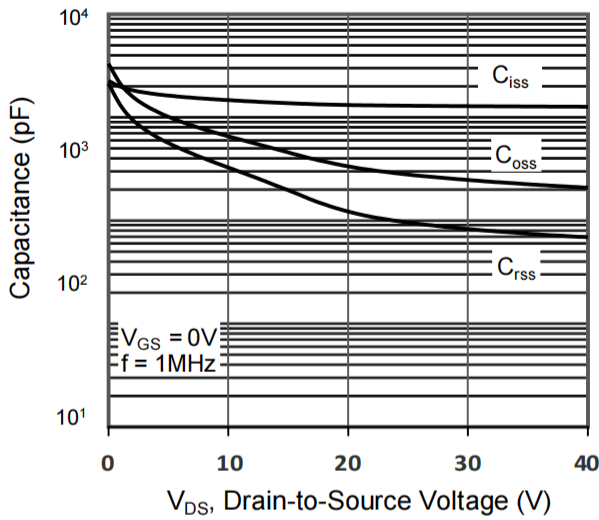

Figure 8. Gate Charge

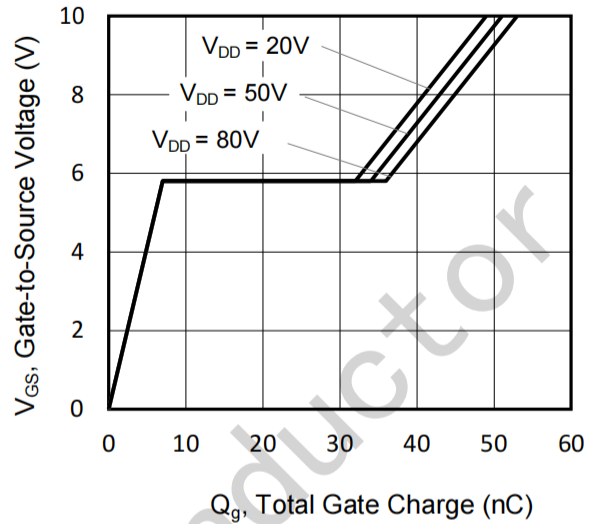

Figure 10. Transient Thermal Impedance  
TO-220, TO-263, TO-252

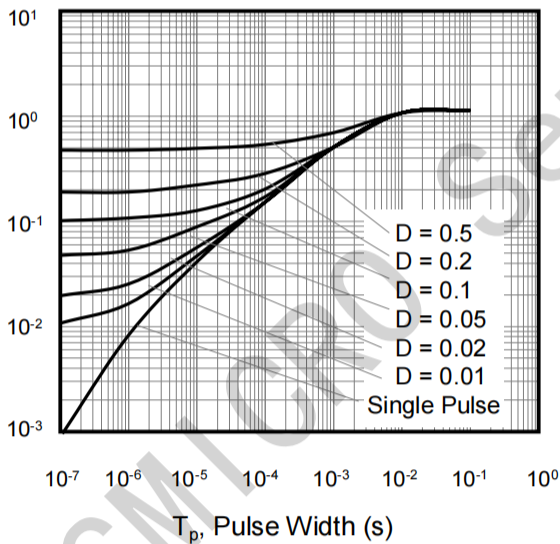

Figure A: Gate Charge Test Circuit and Waveform

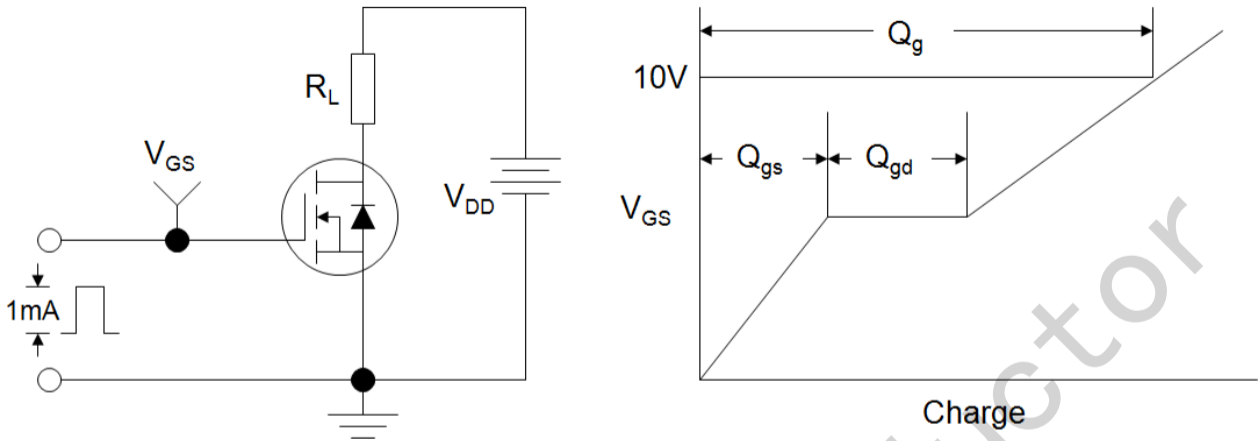

Figure B: Resistive Switching Test Circuit and Waveform

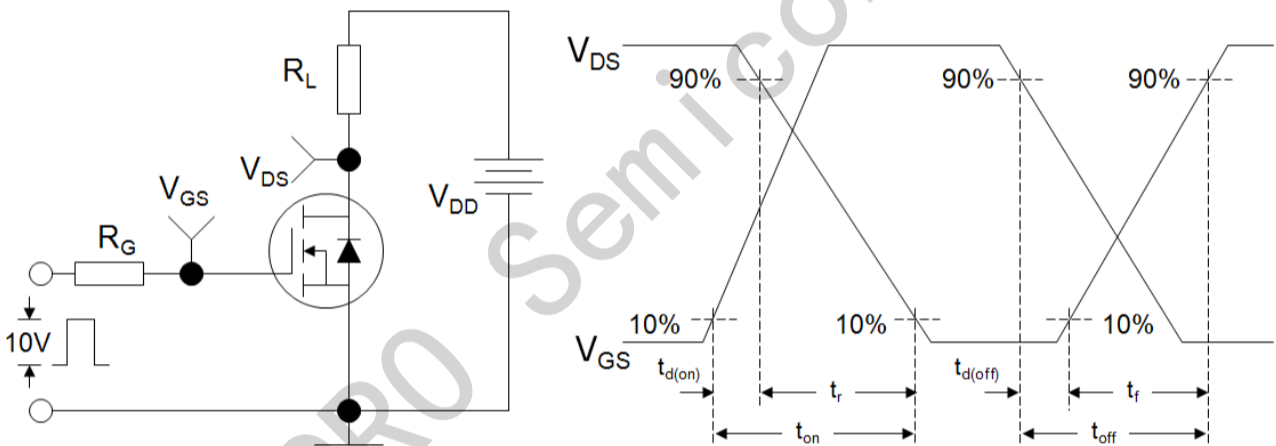
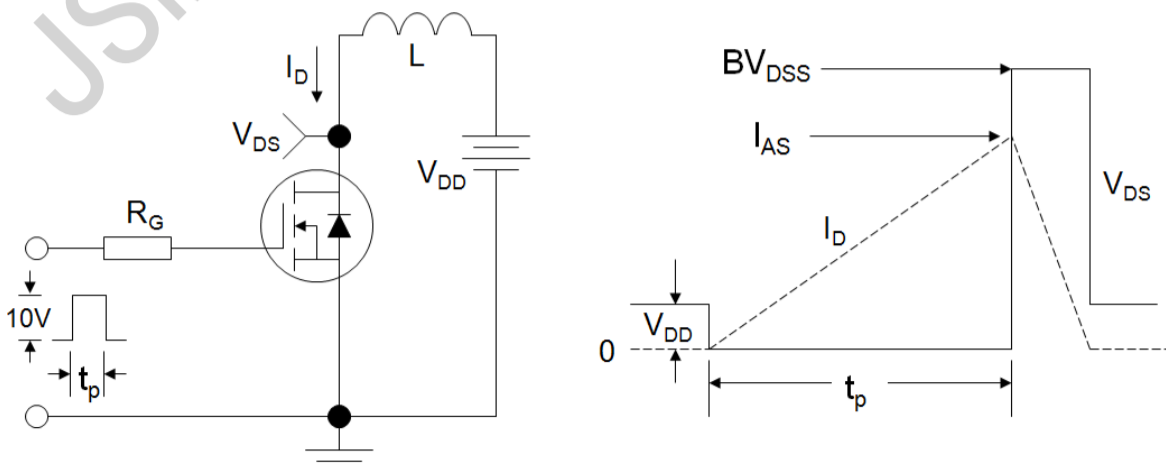
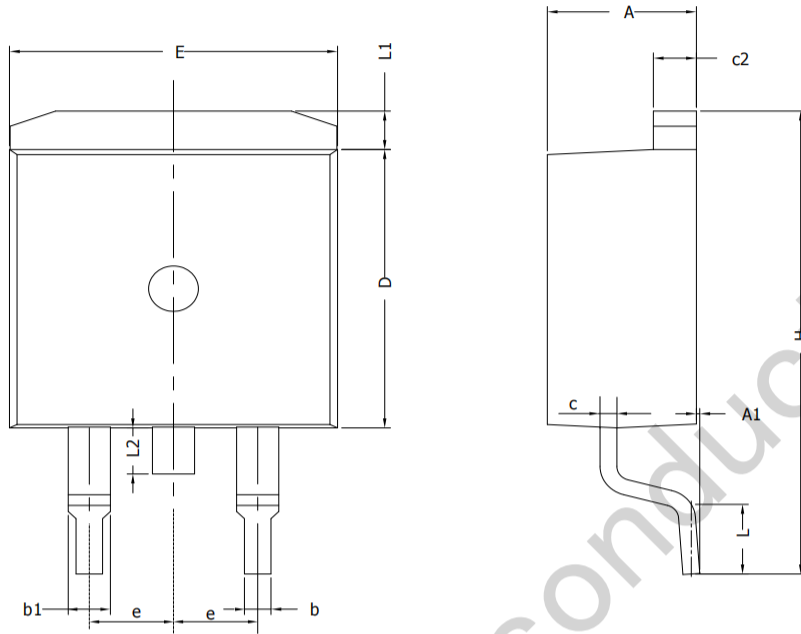

Figure C: Unclamped Inductive Switching Test Circuit and Waveform



Package Outline: TO-263



SYMBOL	MIN	NOM	MAX
A	4.30	4.57	4.72
A1	0	0.10	0.25
b	0.71	0.81	0.91
c	0.30	---	0.60
c2	1.17	1.27	1.37
D	8.50	---	9.35
E	9.80	---	10.45
e	2.54BSC		
H	14.70	---	15.75
L	2.00	2.30	2.74
L1	1.12	1.27	1.42
L2	---	---	1.75

## X-ON Electronics

Largest Supplier of Electrical and Electronic Components

*Click to view similar products for [MOSFET](#) category:*

*Click to view products by [JSMSEMI](#) manufacturer:*

Other Similar products are found below :

[IRFD120](#) [JANTX2N5237](#) [BUK455-60A/B](#) [MIC4420CM-TR](#) [VN1206L](#) [NDP4060](#) [SI4482DY](#) [IPS70R2K0CEAKMA1](#) [SQD23N06-31L-GE3](#)  
[TK16J60W,S1VQ\(O](#) [2SK2614\(TE16L1,Q\)](#) [DMN1017UCP3-7](#) [DMN1053UCP4-7](#) [SQJ469EP-T1-GE3](#) [NTE2384](#) [DMC2700UDMQ-7](#)  
[DMN2080UCB4-7](#) [DMN61D9UWQ-13](#) [US6M2GTR](#) [DMN31D5UDJ-7](#) [DMP22D4UFO-7B](#) [DMN1006UCA6-7](#) [DMN16M9UCA6-7](#)  
[STF5N65M6](#) [IRF40H233XTMA1](#) [STU5N65M6](#) [DMN6022SSD-13](#) [DMN13M9UCA6-7](#) [DMTH10H4M6SPS-13](#) [DMN2990UFB-7B](#)  
[IPB80P04P405ATMA2](#) [2N7002W-G](#) [MCAC30N06Y-TP](#) [MCQ7328-TP](#) [BXP7N65D](#) [BXP4N65F](#) [AOL1454G](#) [WMJ80N60C4](#) [BXP2N20L](#)  
[BXP2N65D](#) [BXT1150N10J](#) [BXT1700P06M](#) [TSM60NB380CP](#) [ROG](#) [RQ7L055BGTCR](#) [DMNH15H110SK3-13](#) [SLF10N65ABV2](#)  
[BSO203SP](#) [BSO211P](#) [IPA60R230P6](#) [IPA60R460CE](#)