

FEATURES

- Fast switching
- 100% avalanche tested
- Improved dv/dt capability

APPLICATIONS

- Switch Mode Power Supply (SMPS)
- Uninterruptible Power Supply (UPS)
- Power Factor Correction (PFC)

Device Marking and Package Information		
Device	Package	Marking
IRF3710PBF	TO-220	IRF3710

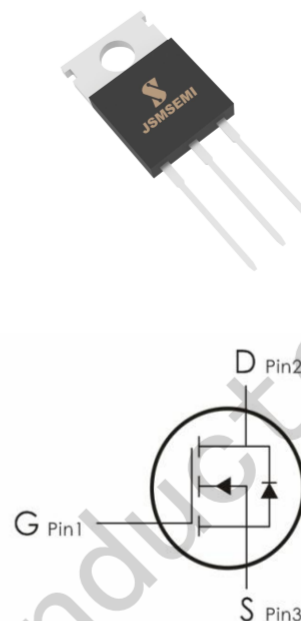

Absolute Maximum Ratings $T_C = 25^\circ\text{C}$, unless otherwise noted			
Parameter	Symbol	Value	Unit
		TO-220	
Drain-Source Voltage ($V_{GS} = 0\text{V}$)	V_{DSS}	100	V
Continuous Drain Current	I_D	60	A
Pulsed Drain Current (note1)	I_{DM}	230	A
Gate-Source Voltage	V_{GSS}	± 20	V
Single Pulse Avalanche Energy (note2)	E_{AS}	1943	mJ
Avalanche Current (note1)	I_{AR}	32	A
Repetitive Avalanche Energy (note1)	E_{AR}	36	mJ
Power Dissipation ($T_C = 25^\circ\text{C}$)	P_D	200	W
Operating Junction and Storage Temperature Range	T_J, T_{stg}	-55 to 175	$^\circ\text{C}$

Thermal Resistance			
Parameter	Symbol	Value	Unit
		TO-220	
Thermal Resistance, Junction-to-Case	R_{thJC}	0.75	$^\circ\text{C/W}$
Thermal Resistance, Junction-to-Ambient	R_{thJA}	62	

Specifications $T_J = 25^\circ\text{C}$, unless otherwise noted						
Parameter	Symbol	Test Conditions	Value			Unit
			Min.	Typ.	Max.	
Static						
Drain-Source Breakdown Voltage	$V_{(BR)DSS}$	$V_{GS} = 0V, I_D = 250\mu A$	100	--	--	V
Zero Gate Voltage Drain Current	I_{DSS}	$V_{DS} = 100V, V_{GS} = 0V, T_J = 25^\circ\text{C}$	--	--	1	μA
		$V_{DS} = 80V, V_{GS} = 0V, T_J = 125^\circ\text{C}$	--	--	100	
Gate-Source Leakage	I_{GSS}	$V_{GS} = +20V, V_{DS} = 0V$	--	--	100	nA
		$V_{GS} = -20V, V_{DS} = 0V$	--	--	-100	
Gate-Source Threshold Voltage	$V_{GS(th)}$	$V_{DS} = V_{GS}, I_D = 250\mu A$	2.0	--	4.0	V
Drain-Source On-Resistance (Note3)	$R_{DS(on)}$	$V_{GS} = 10V, I_D = 28A$	--	17	21	m Ω
Forward Transconductance	gfs	$V_{DS} = 10V, I_D = 28A$		85		S
Dynamic						
Input Capacitance	C_{iss}	$V_{GS} = 0V,$ $V_{DS} = 25V,$ $f = 1.0MHz$	--	2700	--	pF
Output Capacitance	C_{oss}		--	610	--	
Reverse Transfer Capacitance	C_{rss}		--	260	--	
Total Gate Charge	Q_g	$V_{DD} = 50V, I_D = 28A,$ $V_{GS} = 0 \text{ to } 10V$	--	60	--	nC
Gate-Source Charge	Q_{gs}		--	15	--	
Gate-Drain Charge	Q_{gd}		--	45	--	
Turn-on Delay Time	$t_{d(on)}$	$V_{DD} = 50V,$ $I_D = 28A,$ $V_{GS} = 10V$ $R_G = 2.5 \Omega$	--	20	--	ns
Turn-on Rise Time	t_r		--	28	--	
Turn-off Delay Time	$t_{d(off)}$		--	65	--	
Turn-off Fall Time	t_f		--	15	--	
Drain-Source Body Diode Characteristics						
Continuous Body Diode Current	I_S	$T_C = 25^\circ\text{C}$	--	--	60	A
Pulsed Diode Forward Current	I_{SM}		--	--	230	
Body Diode Voltage	V_{SD}	$T_J = 25^\circ\text{C}, I_{SD} = 28A, V_{GS} = 0V$	--	--	1.5	V
Reverse Recovery Time	t_{rr}	$V_{GS} = 0V, I_S = 28A,$ $di_F/dt = 100A/\mu s$	--	195	--	ns
Reverse Recovery Charge	Q_{rr}		--	107	--	μC

Notes

1. Repetitive Rating: Pulse width limited by maximum junction temperature
2. $I_{AS} = 30A, V_{DD} = 50V, R_G = 25 \Omega$, Starting $T_J = 25^\circ\text{C}$
3. Pulse Test: Pulse width $\leq 300\mu s$, Duty Cycle $\leq 1\%$

Typical Characteristics $T_J = 25^\circ\text{C}$, unless otherwise noted

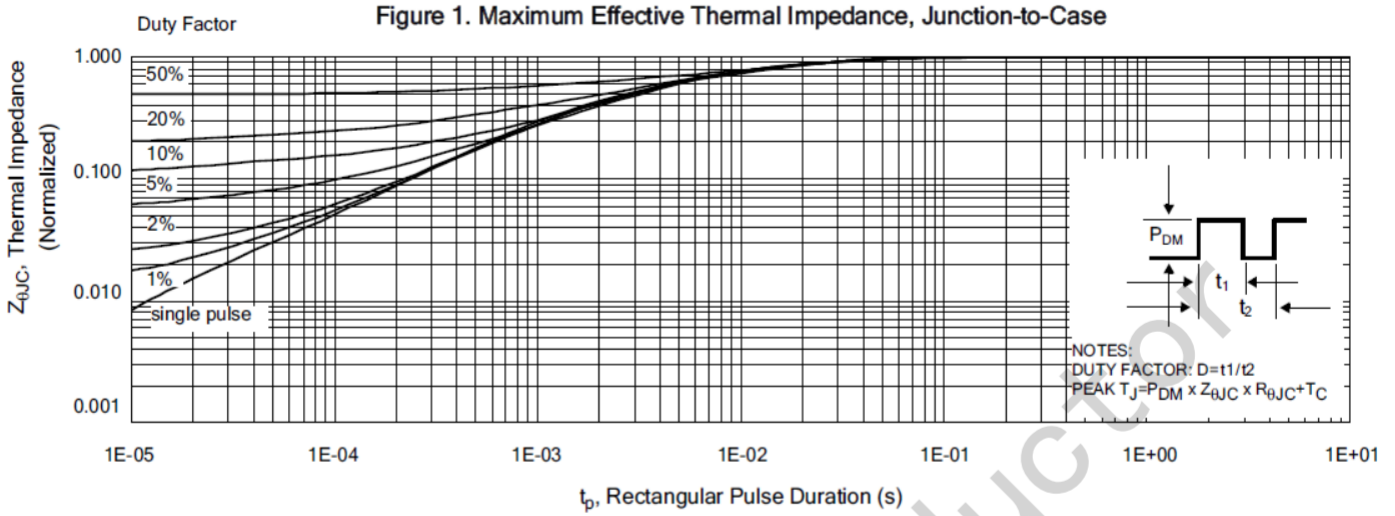

Figure 2. Maximum Power Dissipation vs Case Temperature

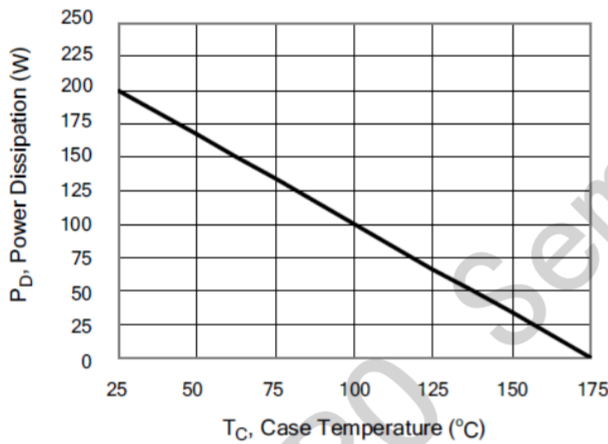

Figure 3. Maximum Continuous Drain Current vs Case Temperature

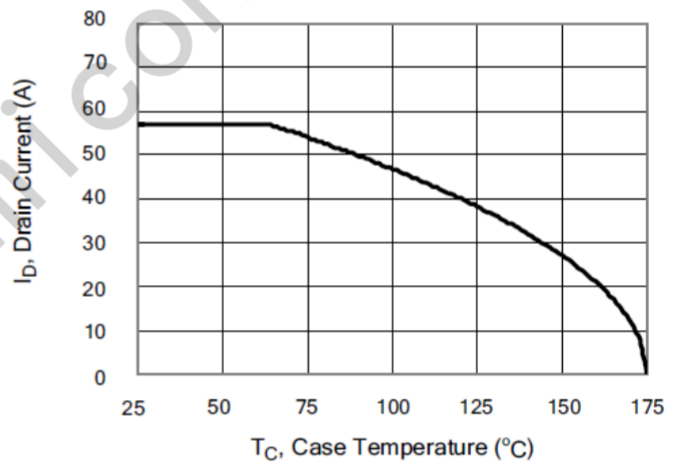

Figure 4. Typical Output Characteristics

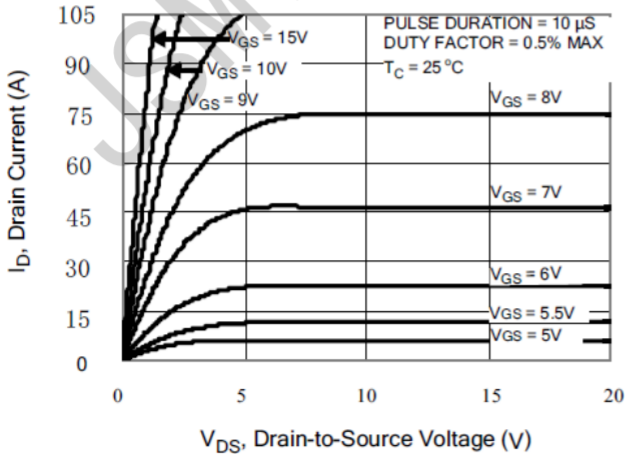
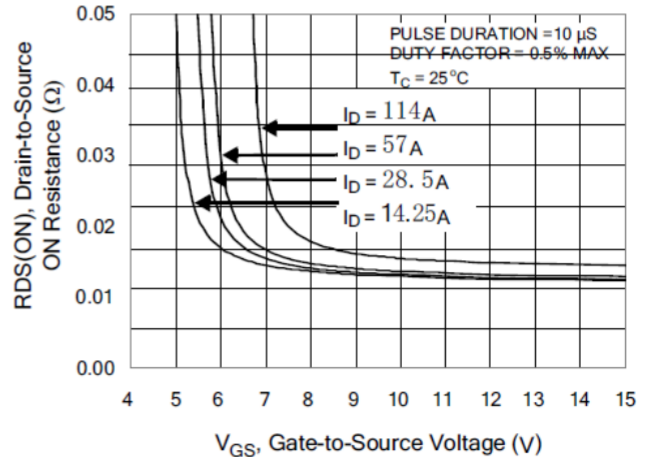

Figure 5. Typical Drain-to-Source ON Resistance vs Gate Voltage and Drain Current



Typical Characteristics $T_J = 25^\circ\text{C}$, unless otherwise noted

Figure 6. Maximum Peak Current Capability

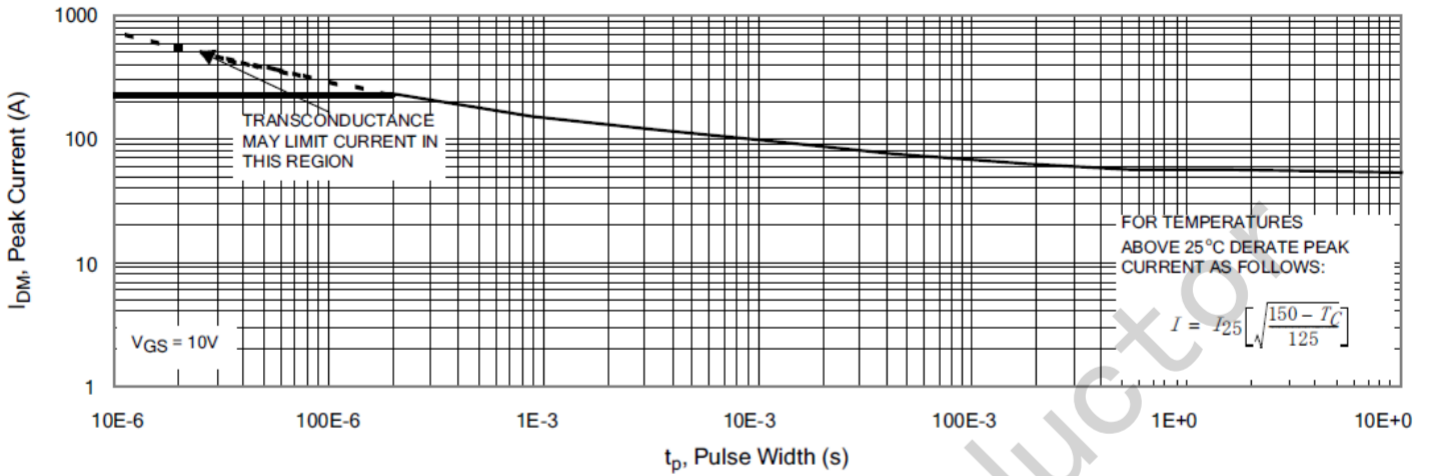

Figure 7. Typical Transfer Characteristics

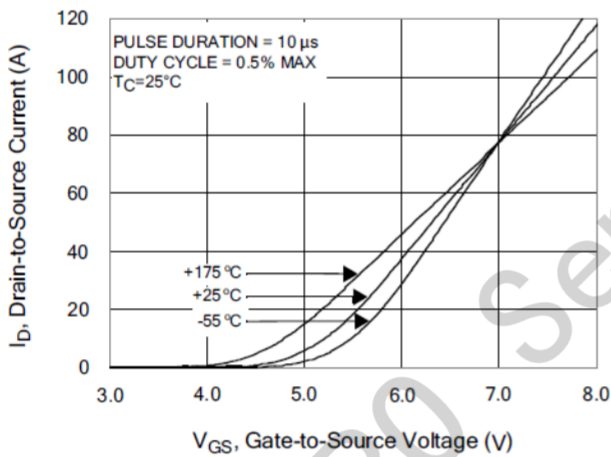

Figure 8. Unclamped Inductive Switching Capability

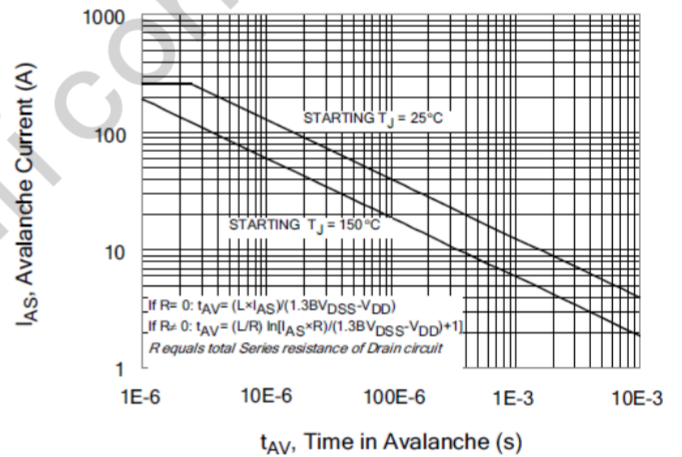

Figure 9. Typical Drain-to-Source ON Resistance vs Drain Current

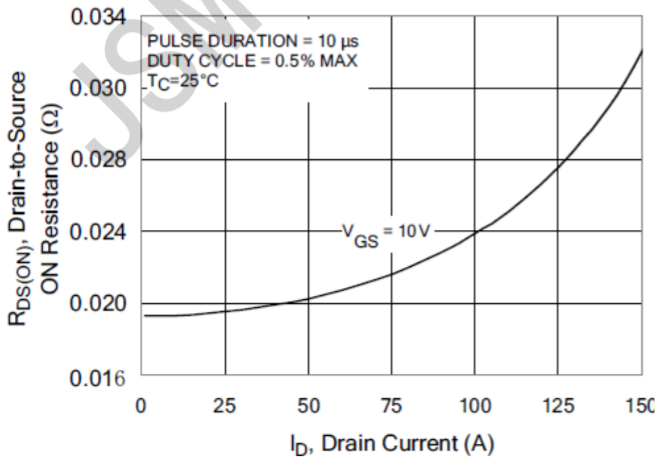
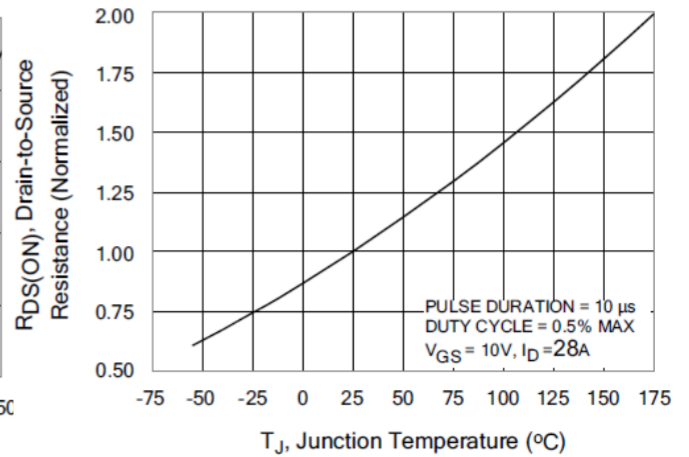

Figure 10. Typical Drain-to-Source ON Resistance vs Junction Temperature



Typical Characteristics $T_J = 25^\circ\text{C}$, unless otherwise noted
Figure 11. Typical Breakdown Voltage vs Junction Temperature

Figure 13. Maximum Forward Bias Safe Operating Area

Figure 15. Typical Gate Charge

Figure 12. Typical Threshold Voltage vs Junction Temperature

Figure 14. Capacitance vs Vds

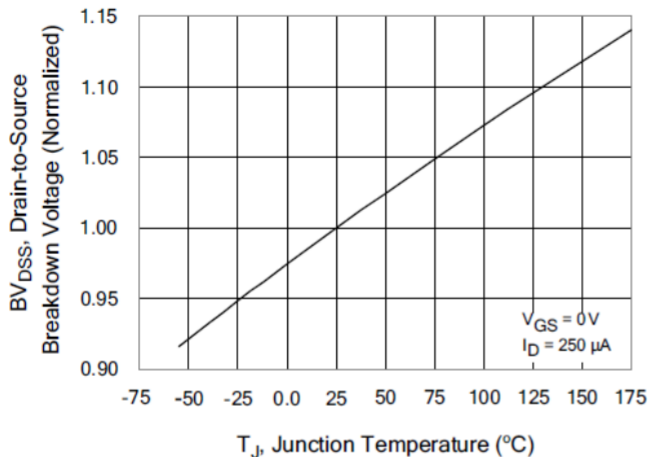
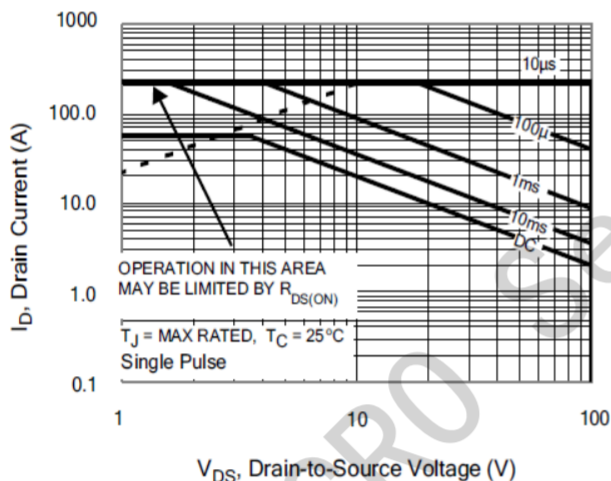
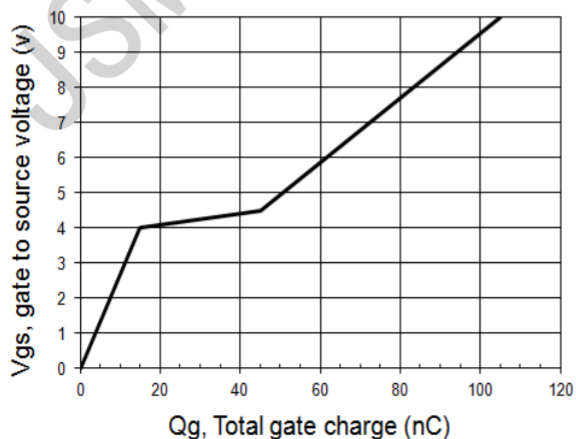
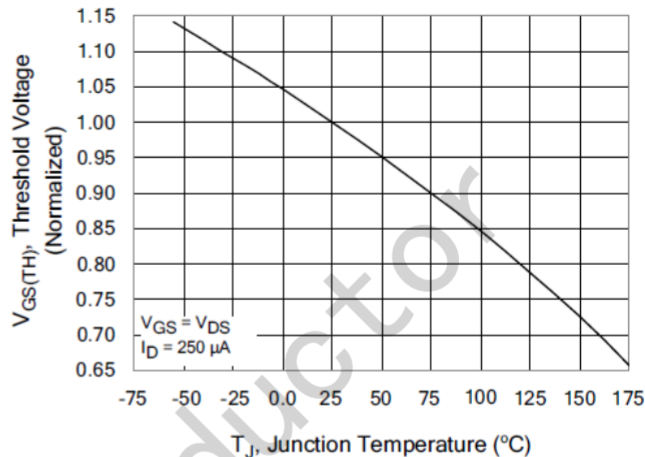
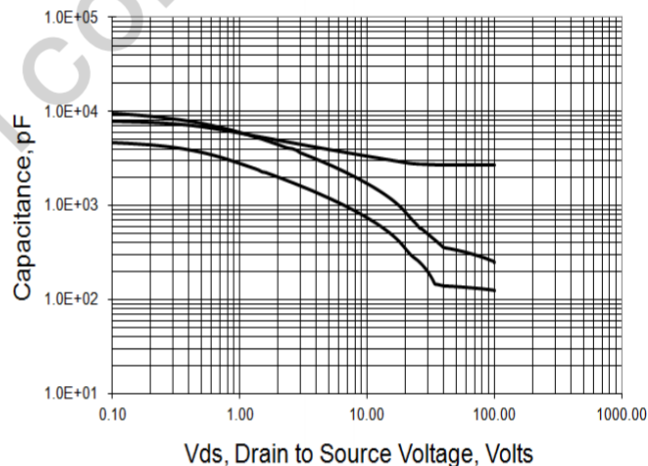
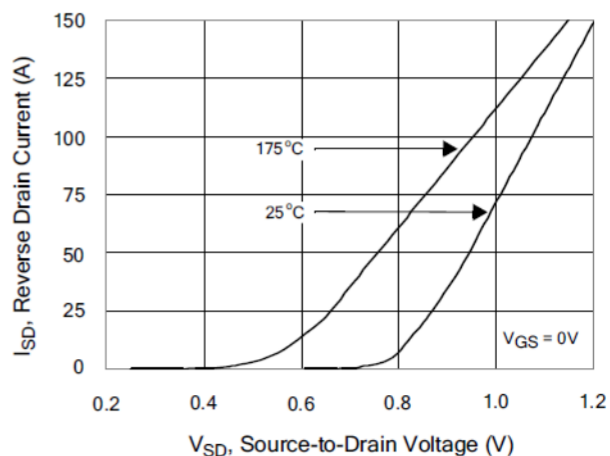
Figure 16. Typical Body Diode Transfer Characteristics

Figure A: Gate Charge Test Circuit and Waveform

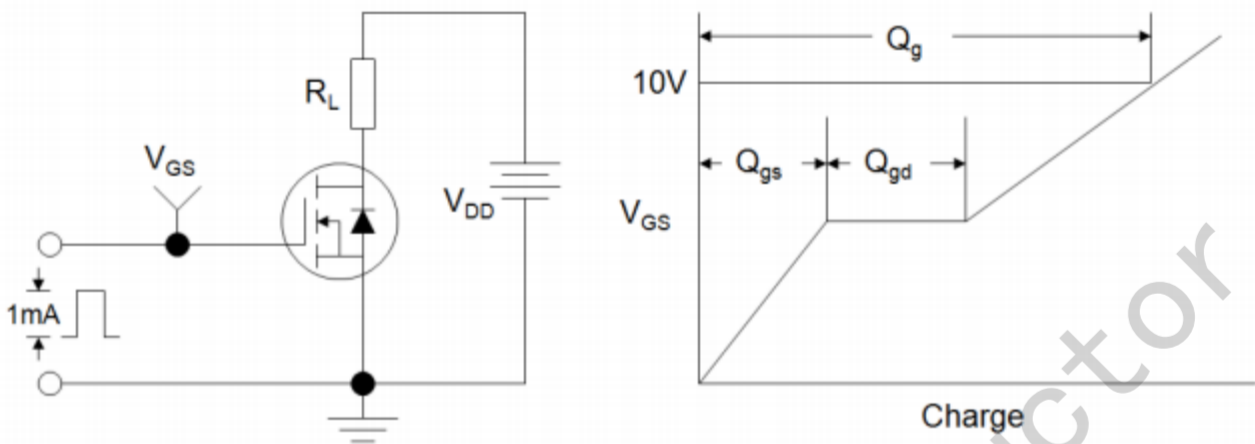

Figure B: Resistive Switching Test Circuit and Waveform

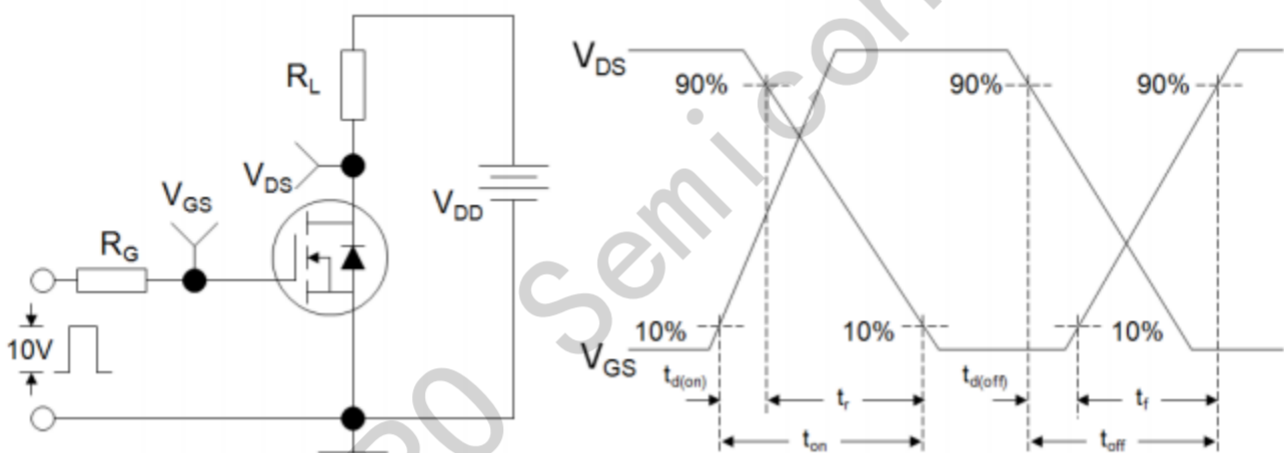
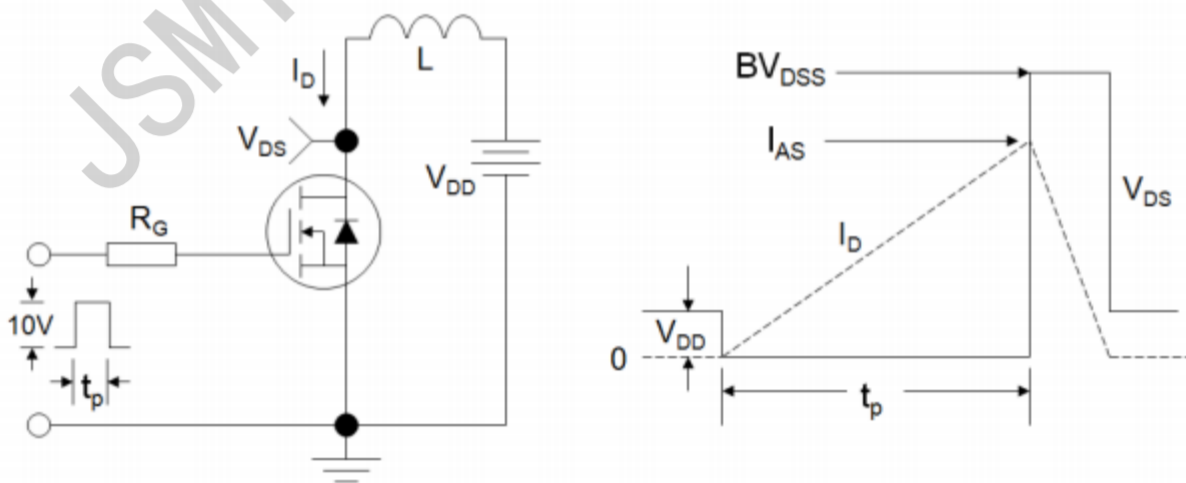
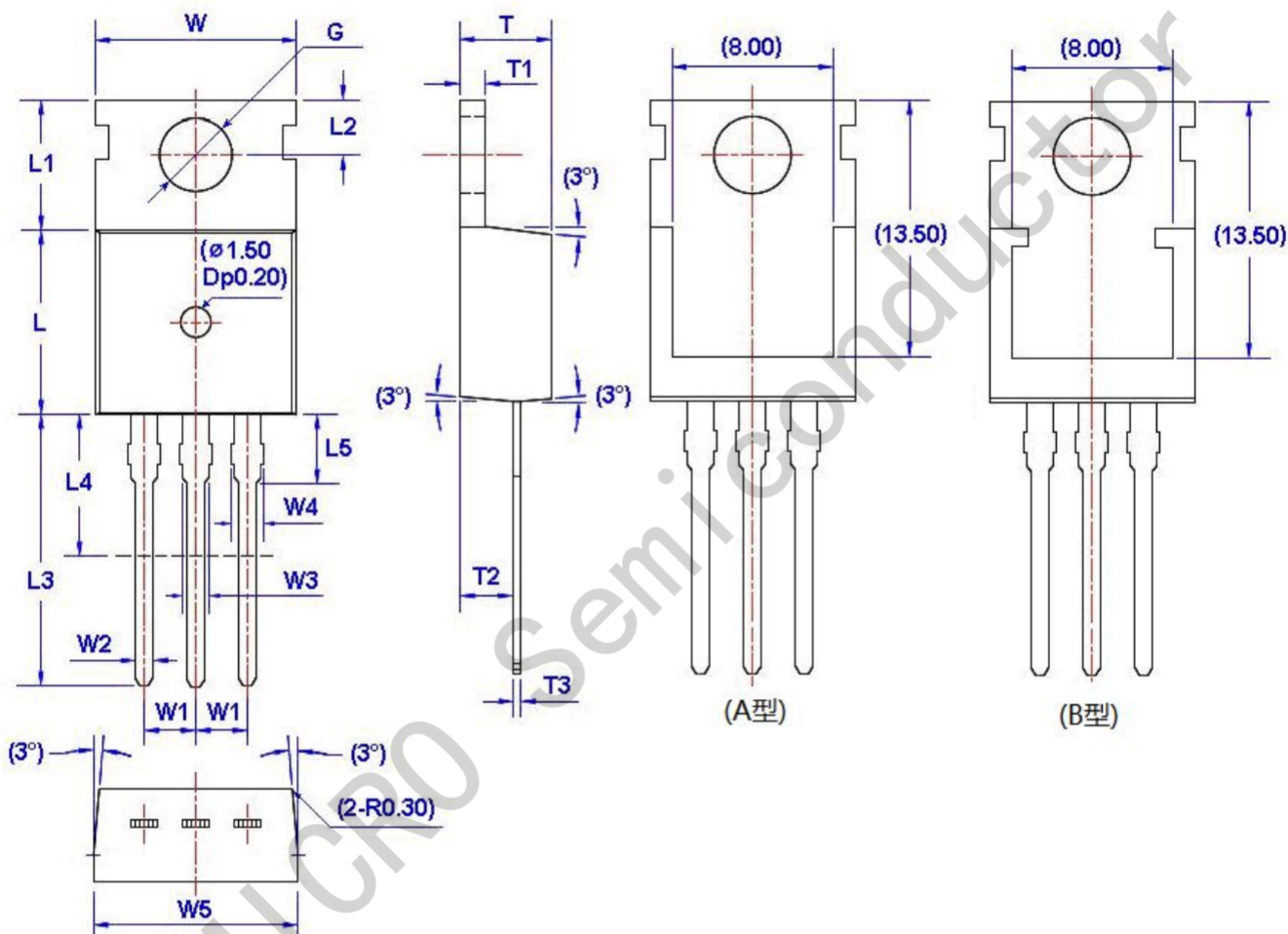

Figure C: Unclamped Inductive Switching Test Circuit and Waveform



Package Information

TO-220



Unit: mm

Symbol	Size		Symbol	Size		Symbol	Size		Symbol	Size	
	Min	Max		Min	Max		Min	Max		Min	Max
W	9.66	10.28	W5	9.80	10.20	L4**	6.20	6.60	T3	0.45	0.60
W1	2.54 (TYP)		L	9.00	9.40	L5	2.79	3.30	G(Φ)	3.50	3.70
W2	0.70	0.95	L1	6.40	6.80	T	4.30	4.70			
W3	1.17	1.37	L2	2.70	2.90	T1	1.15	1.40			
W4*	1.32	1.72	L3	12.70	14.27	T2	2.20	2.60			

X-ON Electronics

Largest Supplier of Electrical and Electronic Components

Click to view similar products for [MOSFET](#) category:

Click to view products by [JSMSEMI](#) manufacturer:

Other Similar products are found below :

[IRFD120](#) [JANTX2N5237](#) [BUK455-60A/B](#) [MIC4420CM-TR](#) [VN1206L](#) [NDP4060](#) [SI4482DY](#) [IPS70R2K0CEAKMA1](#) [SQD23N06-31L-GE3](#)
[TK16J60W,S1VQ\(O](#) [2SK2614\(TE16L1,Q\)](#) [DMN1017UCP3-7](#) [DMN1053UCP4-7](#) [SQJ469EP-T1-GE3](#) [NTE2384](#) [DMC2700UDMQ-7](#)
[DMN2080UCB4-7](#) [DMN61D9UWQ-13](#) [US6M2GTR](#) [DMN31D5UDJ-7](#) [DMP22D4UFO-7B](#) [DMN1006UCA6-7](#) [DMN16M9UCA6-7](#)
[STF5N65M6](#) [IRF40H233XTMA1](#) [STU5N65M6](#) [DMN6022SSD-13](#) [DMN13M9UCA6-7](#) [DMTH10H4M6SPS-13](#) [DMN2990UFB-7B](#)
[IPB80P04P405ATMA2](#) [2N7002W-G](#) [MCAC30N06Y-TP](#) [MCQ7328-TP](#) [NTMC083NP10M5L](#) [BXP7N65D](#) [BXP4N65F](#) [AOL1454G](#)
[WMJ80N60C4](#) [BXP2N20L](#) [BXP2N65D](#) [BXT1150N10J](#) [BXT1700P06M](#) [TSM60NB380CP](#) [ROG](#) [RQ7L055BGTGR](#) [DMNH15H110SK3-13](#)
[SLF10N65ABV2](#) [BSO203SP](#) [BSO211P](#) [IPA60R230P6](#)