

Description:

This P-Channel MOSFET uses advanced trench technology and design to provide excellent $R_{DS(on)}$ with low gate charge.

It can be used in a wide variety of applications.

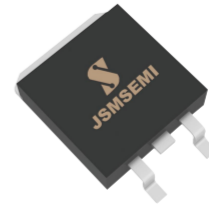

Features:

- 1) $V_{DS}=-60V, I_D=-65A, R_{DS(ON)}<20m\ \Omega @V_{GS}=-10V$
- 2) Low gate charge.
- 3) Green device available.
- 4) Advanced high cell density trench technology for ultra low $R_{DS(ON)}$.
- 5) Excellent package for good heat dissipation.

TO-263

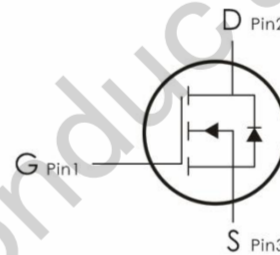

Absolute Maximum Ratings: ($T_C=25^\circ C$ unless otherwise noted)

Symbol	Parameter	Ratings	Units
V_{DS}	Drain-Source Voltage	-60	V
V_{GS}	Gate-Source Voltage	± 20	V
I_D	Continuous Drain Current- $T_C=25^\circ C$	-65	A
	Continuous Drain Current- $T_C=100^\circ C$	-45	A
I_{DM}	Pulsed Drain Current ¹	-280	A
P_D	Total Power Dissipation	280	W
E_{AS}	Single Pulsed Avalanche Energy	750	mJ
T_J, T_{STG}	Operating and Storage Junction Temperature Range	-55 to +150	$^\circ C$

Thermal Characteristics:

Symbol	Parameter	Max	Units
$R_{\theta JC}$	Thermal Resistance, Junction to Case	0.44	$^\circ C/W$

Electrical Characteristics: ($T_C=25^\circ\text{C}$ unless otherwise noted)

Symbol	Parameter	Conditions	Min	Typ	Max	Units
Off Characteristics						
BV_{DSS}	Drain-Source Breakdown Voltage	$V_{GS}=0V, I_D=-250\ \mu\text{A}$	-60	---	---	V
I_{DSS}	Zero Gate Voltage Drain Current	$V_{GS}=0V, V_{DS}=-60V$	---	---	-1	μA
I_{GSS}	Gate-Source Leakage Current	$V_{GS}=\pm 20V, V_{DS}=0A$	---	---	± 100	nA
On Characteristics						
$V_{GS(th)}$	GATE-Source Threshold Voltage	$V_{GS}=V_{DS}, I_D=-250\ \mu\text{A}$	-1.1	-1.6	-2.2	V
$R_{DS(on)}$	Static Drain-Source On-Resistance	$V_{GS}=-10V, I_D=-20A$	---	16.5	20	m Ω
		$V_{GS}=-4.5V, I_D=-20A$	---	18.5	22	
Dynamic Characteristics						
C_{iss}	Input Capacitance	$V_{DS}=-20V, V_{GS}=0V, f=1\text{MHz}$	---	4399	---	pF
C_{oss}	Output Capacitance		---	258	---	
C_{rss}	Reverse Transfer Capacitance		---	211	---	
Switching Characteristics						
$t_{d(on)}$	Turn-On Delay Time	$V_{DD}=-30V, I_D=-20A,$ $V_{GS}=-10V, R_G=1\ \Omega$	---	23	---	ns
t_r	Rise Time		---	17	---	ns
$t_{d(off)}$	Turn-Off Delay Time		---	55	---	ns
t_f	Fall Time		---	29	---	ns
Q_g	Total Gate Charge	$V_{GS}=-10V, V_{DS}=-30V,$ $I_D=-20A$	---	114	---	nC
Q_{gs}	Gate-Source Charge		---	27.3	---	nC
Q_{gd}	Gate-Drain "Miller" Charge		---	49	---	nC
Drain-Source Diode Characteristics						
V_{SD}	Drain Diode Forward Voltage	$V_{GS}=0V, I_S=-20A$	---	---	-1.2	V

I_S	Continuous Source Current	$V_G=V_D=0V$	---	---	-65	A
I_{SM}	Pulsed Source Current		---	---	-280	A
T_{rr}	Reverse Recovery Time	$T_J = 25^\circ C, I_F = -20A,$ $di/dt = 100A/\mu s$	---	117	---	nS
Q_{rr}	Reverse Recovery Charge		---	420	---	nC

Notes:

1. Repetitive Rating: Pulse Width Limited by Maximum Junction Temperature
2. EAS condition: $T_J = 25^\circ C, V_{DD} = -25V, V_G = -5V, R_G = 25\Omega, L = 0.5mH, I_{AS}$
3. Pulse Test: Pulse Width $\leq 300\mu s$, Duty Cycle $\leq 0.5\%$

Typical Characteristics: ($T_C = 25^\circ C$ unless otherwise noted)

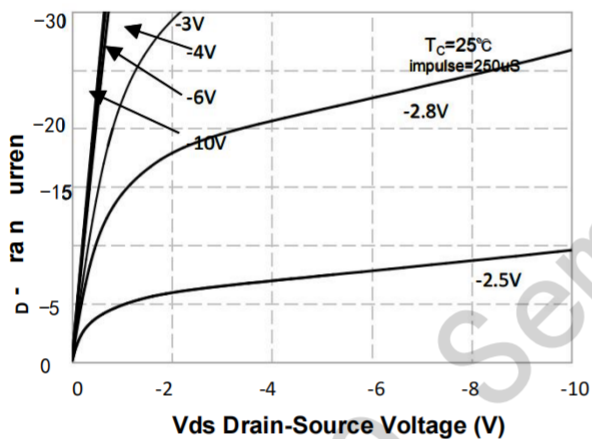

Figure 1. On-Region Characteristics

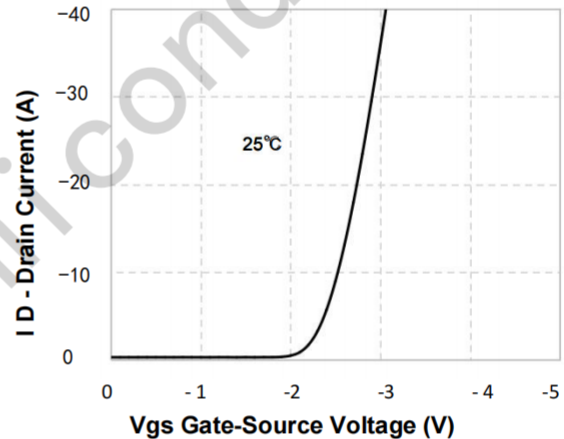

Figure 2. Transfer Characteristics

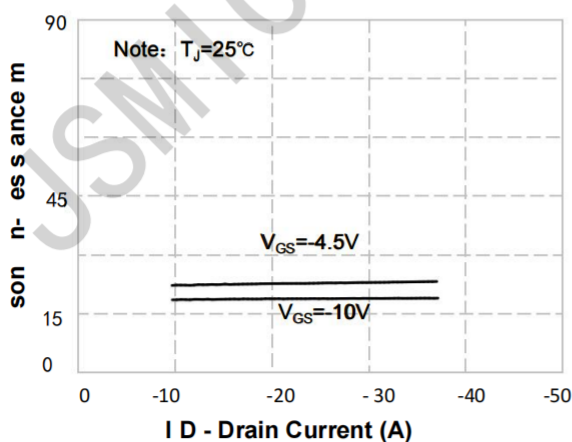

Figure 3. On-Resistance Variation vs Drain Current and Gate Voltage

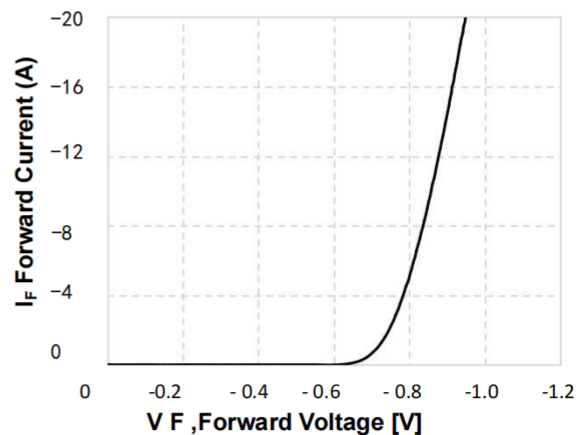

Figure 4. Body Diode Forward Voltage Variation with Source Current and Temperature

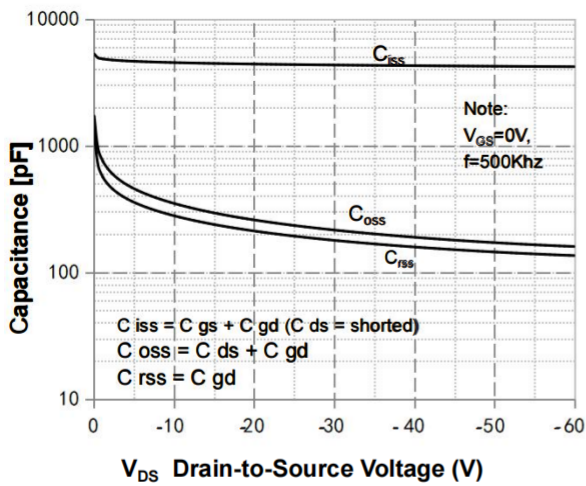

Figure 5. Capacitance Characteristics

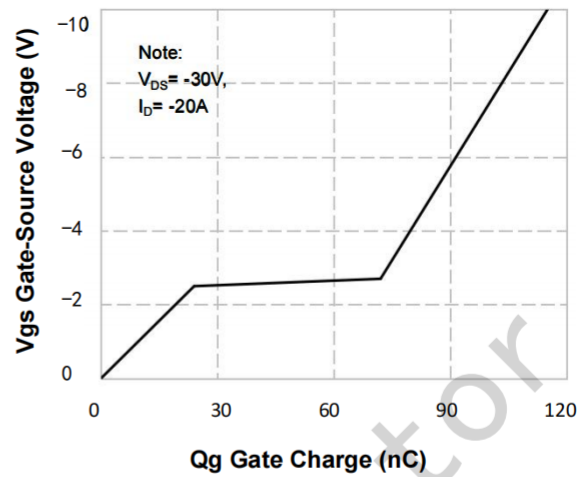

Figure 6. Gate Charge Characteristics

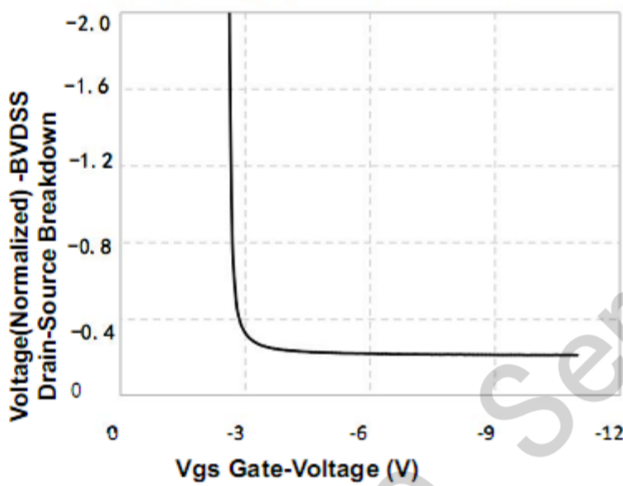

Figure 7. Breakdown Voltage Variation vs Gate-Voltage

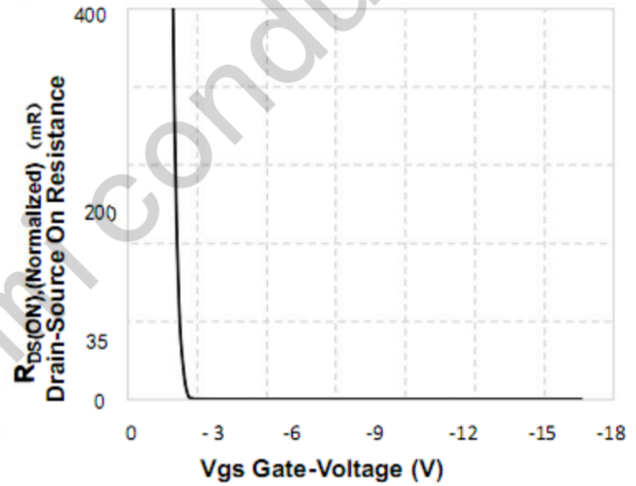

Figure 8. On-Resistance Variation vs Gate Voltage

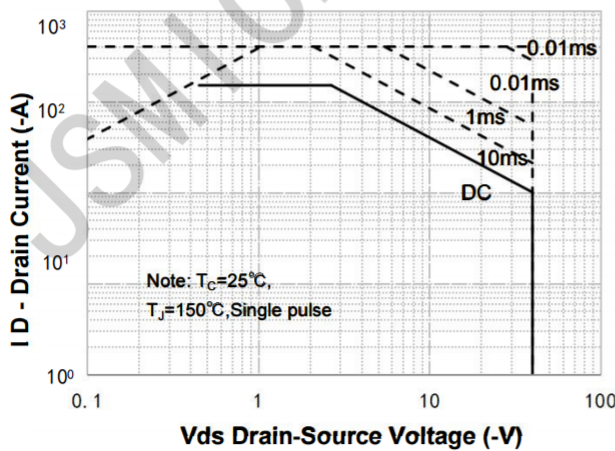

Figure 9. Maximum Safe Operating Area

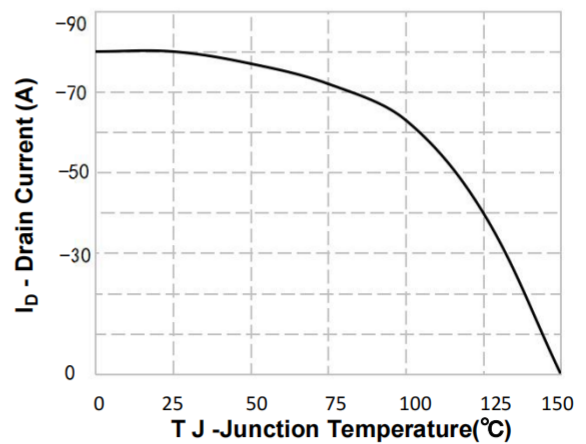

Figure 10. Maximum PContinuous Drain Current vs Case Temperature

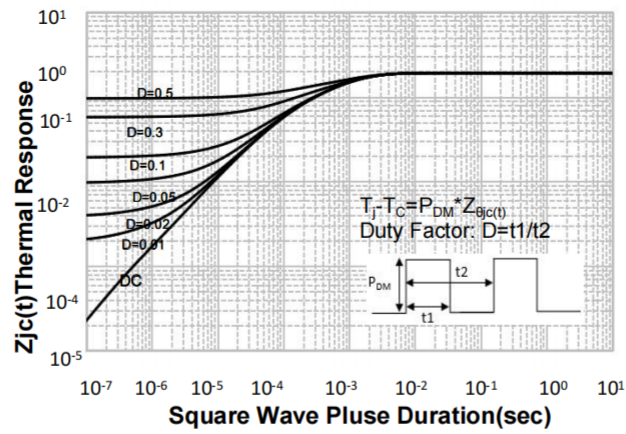

Figure 11. Transient Thermal Response Curve

JSMICRO Semiconductor

Package Information

TO-263

Unit: mm

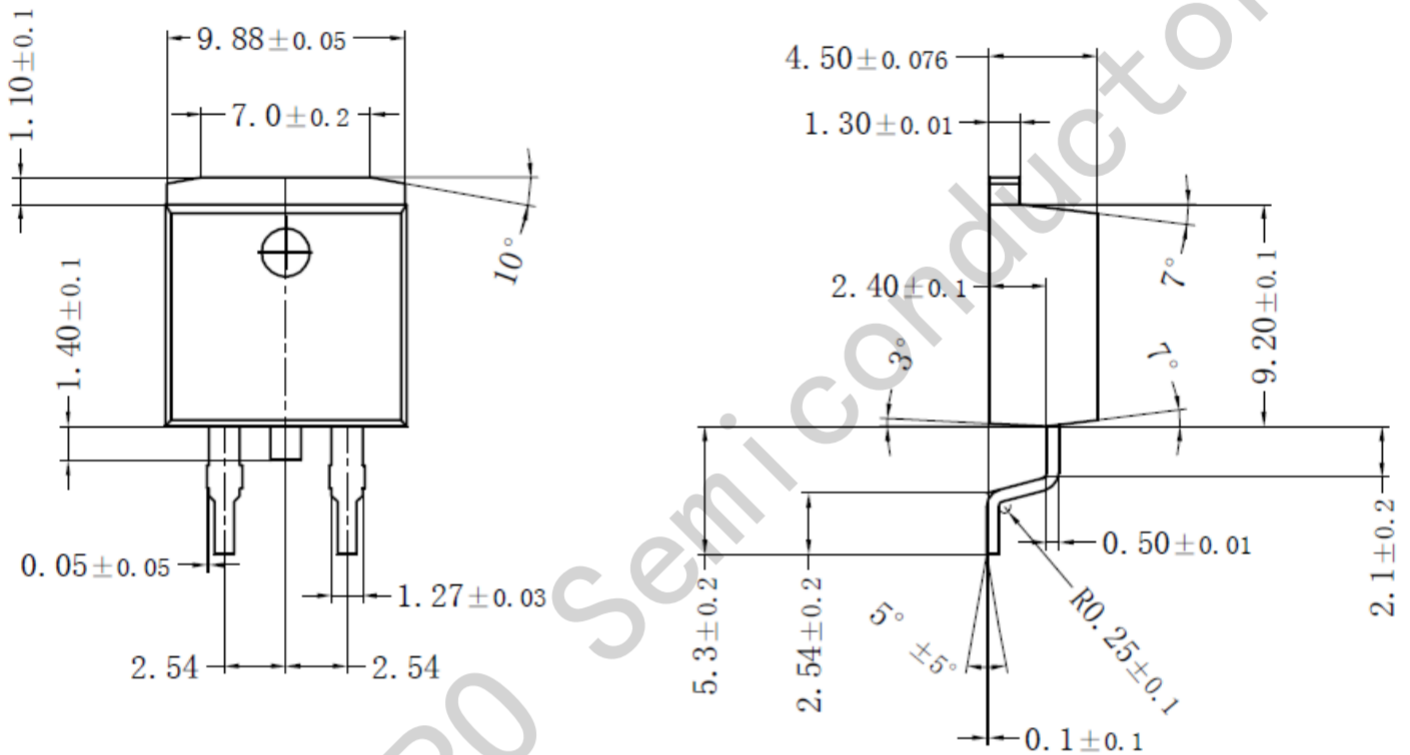

X-ON Electronics

Largest Supplier of Electrical and Electronic Components

Click to view similar products for [MOSFET](#) category:

Click to view products by [JSMSEMI](#) manufacturer:

Other Similar products are found below :

[IRFD120](#) [IRFY240C](#) [JANTX2N5237](#) [2SK2267\(Q\)](#) [BUK455-60A/B](#) [MIC4420CM-TR](#) [VN1206L](#) [NDP4060](#) [SI4482DY](#)
[IPS70R2K0CEAKMA1](#) [SQD23N06-31L-GE3](#) [TK16J60W,S1VQ\(O](#) [2SK2614\(TE16L1,Q\)](#) [DMN1017UCP3-7](#) [EFC2J004NUZTDG](#)
[DMN1053UCP4-7](#) [SQJ469EP-T1-GE3](#) [NTE2384](#) [DMC2700UDMQ-7](#) [DMN2080UCB4-7](#) [DMN61D9UWQ-13](#) [US6M2GTR](#)
[DMN31D5UDJ-7](#) [DMP22D4UFO-7B](#) [DMN1006UCA6-7](#) [DMN16M9UCA6-7](#) [STF5N65M6](#) [IRF40H233XTMA1](#) [STU5N65M6](#)
[DMN6022SSD-13](#) [DMN13M9UCA6-7](#) [DMTH10H4M6SPS-13](#) [DMN2990UFB-7B](#) [IPB80P04P405ATMA2](#) [2N7002W-G](#) [MCAC30N06Y-](#)
[TP](#) [MCQ7328-TP](#) [NTMC083NP10M5L](#) [NVMFS2D3P04M8LT1G](#) [BXP7N65D](#) [BXP4N65F](#) [AOL1454G](#) [WMJ80N60C4](#) [BXP2N20L](#)
[BXP2N65D](#) [BXT1150N10J](#) [BXT1700P06M](#) [TSM60NB380CP](#) [ROG](#) [RQ7L055BGTCR](#) [DMNH15H110SK3-13](#)