

## FEATURES

- Fast switching
- 100% avalanche tested
- Improved dv/dt capability

## APPLICATIONS

- Switch Mode Power Supply (SMPS)
- Uninterruptible Power Supply (UPS)
- Power Factor Correction (PFC)

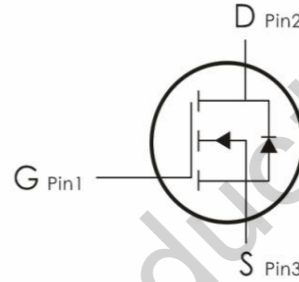
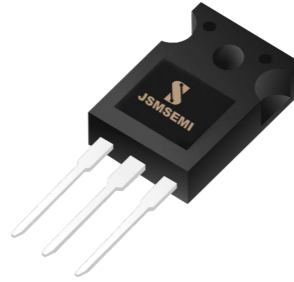

Device Marking and Package Information		
Device	Package	Marking
IRFP4668PBF	TO-247	IRFP4668

Absolute Maximum Ratings $T_C = 25^\circ\text{C}$ , unless otherwise noted			
Parameter	Symbol	Value	Unit
		TO-247	
Drain-Source Voltage ( $V_{GS} = 0\text{V}$ )	$V_{DSS}$	220	V
Continuous Drain Current $V_{GS} = 10\text{V}$ $T_C = 25^\circ\text{C}$	$I_D$	130	A
Pulsed Drain Current (note1)	$I_{DM}$	530	A
Gate-Source Voltage	$V_{GSS}$	$\pm 20$	V
Single Pulse Avalanche Energy (note2)	$E_{AS}$	1960.2	mJ
Avalanche Current (note1)	$I_{AS}$	19.8	A
Repetitive Avalanche Energy (note1)	$E_{AR}$	1176.1	mJ
Power Dissipation ( $T_C = 25^\circ\text{C}$ )	$P_D$	700	W
Peak Diode Recovery dv/dt (note1)	dv/dt	5.0	
Operating Junction and Storage Temperature Range	$T_J, T_{stg}$	-55~+150	$^\circ\text{C}$

Thermal Resistance			
Parameter	Symbol	Value	Unit
Thermal Resistance, Junction-to-Case	$R_{thJC}$	0.89	$^\circ\text{C/W}$
Thermal Resistance, Junction-to-Ambient	$R_{thJA}$	60	

Specifications $T_J = 25^\circ\text{C}$ , unless otherwise noted						
Parameter	Symbol	Test Conditions	Value			Unit
			Min.	Typ.	Max.	
<b>Static</b>						
Drain-Source Breakdown Voltage	$V_{(BR)DSS}$	$V_{GS} = 0V, I_D = 250\mu A$	220	--	--	V
Zero Gate Voltage Drain Current	$I_{DSS}$	$V_{DS} = 40V, V_{GS} = 0V, T_J = 25^\circ\text{C}$	--	--	1	$\mu A$
		$V_{DS} = 32V, V_{GS} = 0V, T_J = 125^\circ\text{C}$	--	--	100	
Gate-Source Leakage	$I_{GSS}$	$V_{GS} = \pm 20V$	--	--	$\pm 100$	nA
Gate-Source Threshold Voltage	$V_{GS(th)}$	$V_{DS} = V_{GS}, I_D = 250\mu A$	2.0	--	4.0	V
Drain-Source On-Resistance (Note3)	$R_{DS(on)}$	$V_{GS} = 10V, I_D = 95A(\text{Note4})$	--	12	27	$m\Omega$
<b>Dynamic</b>						
Input Capacitance	$C_{iss}$	$V_{GS} = 0V,$ $V_{DS} = 25V,$ $f = 1.0\text{MHz}$	--	5784	--	$\mu F$
Output Capacitance	$C_{oss}$		--	893	--	
Reverse Transfer Capacitance	$C_{rss}$		--	561	--	
Total Gate Charge	$Q_g$	$V_{DD} = 20V, I_D = 190A,$ $V_{GS} = 10V(\text{Note4})$	--	367	--	nC
Gate-Source Charge	$Q_{gs}$		--	33.8	--	
Gate-Drain Charge	$Q_{gd}$		--	177	--	
Turn-on Delay Time	$t_{d(on)}$	$V_{DD} = 20V, I_D = 190A,$ $R_G = 10\Omega, V_{GS} = 10V$ (Note4)	--	55	--	ns
Turn-on Rise Time	$t_r$		--	165	--	
Turn-off Delay Time	$t_{d(off)}$		--	1050	--	
Turn-off Fall Time	$t_f$		--	367	--	
<b>Drain-Source Body Diode Characteristics</b>						
Continuous Body Diode Current	$I_S$	$T_C = 25^\circ\text{C}$	--	--	130	A
Pulsed Diode Forward Current	$I_{SM}$		--	--	530	
Body Diode Voltage	$V_{SD}$	$T_J = 25^\circ\text{C}, I_{SD} = 95A, V_{GS} = 0V$	--	--	1.4	V
Reverse Recovery Time	$t_{rr}$	$V_{GS} = 0V, I_S = 190A,$ $di_F/dt = 100A/\mu s$	--	360	--	ns
Reverse Recovery Charge	$Q_{rr}$		--	5.61	--	$\mu C$

**Notes**

1. Repetitive Rating: Pulse width limited by maximum junction temperature
2.  $L = 10\text{mH}, V_{DD} = 50V, R_G = 25\Omega$ , Starting  $T_J = 25^\circ\text{C}$
3. Pulse Test: Pulse width  $\leq 300\mu s$ , Duty Cycle  $\leq 1\%$

**Typical Characteristics**  $T_J = 25^\circ\text{C}$ , unless otherwise noted

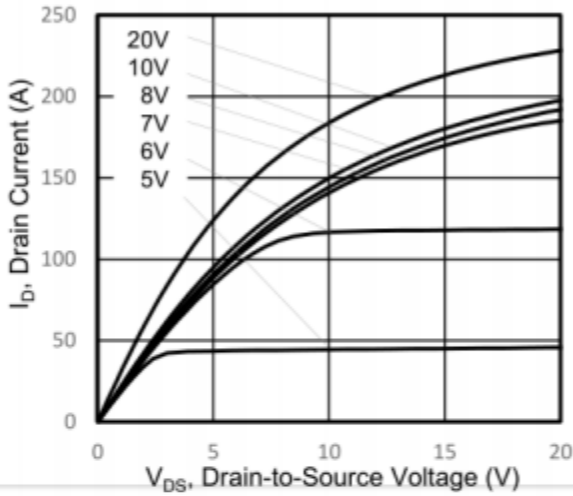
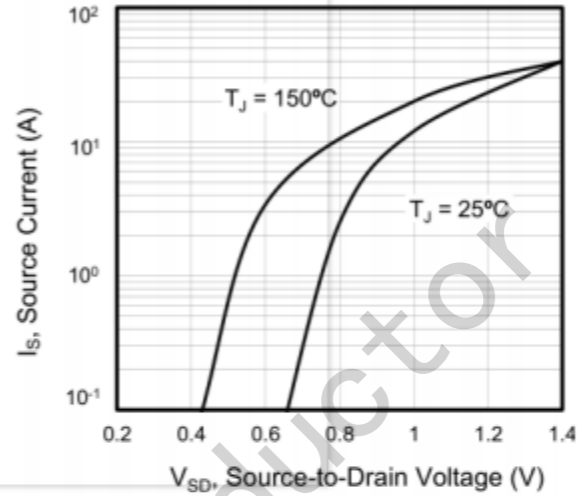
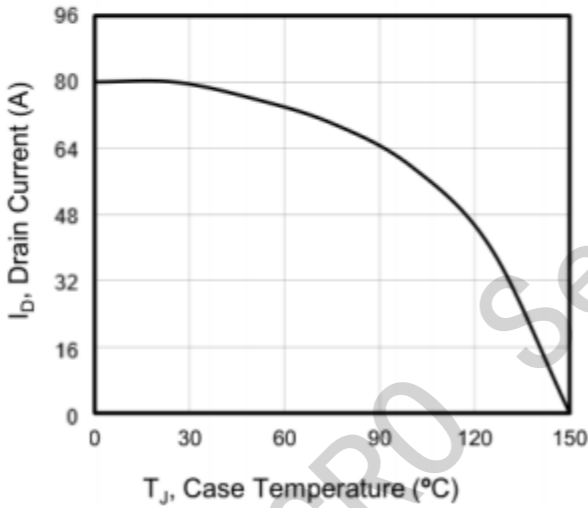
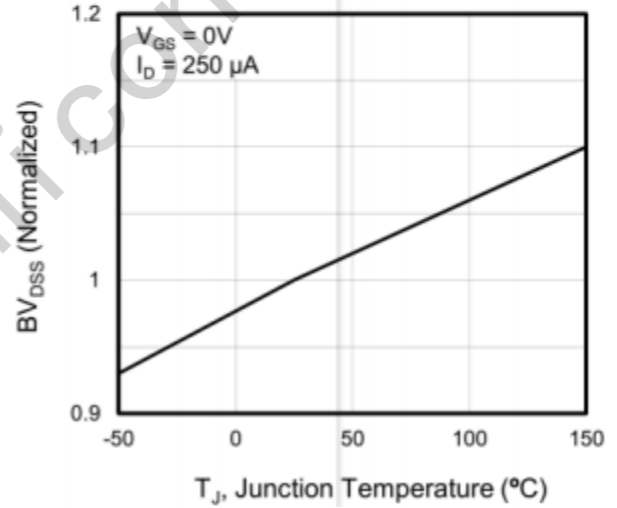
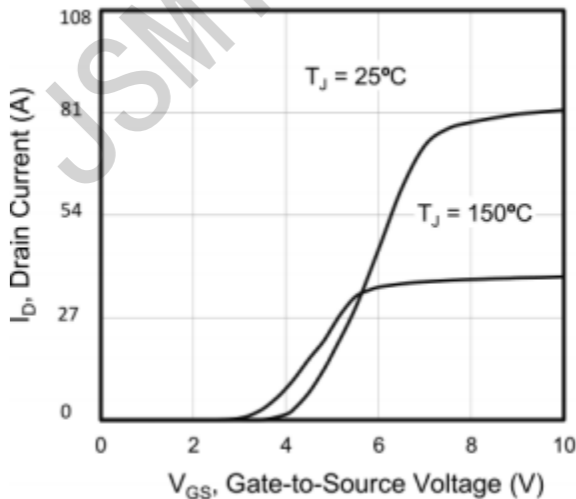
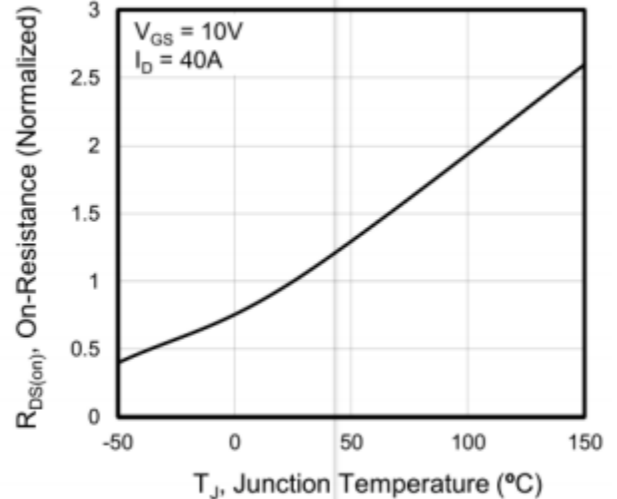
**Figure 1. Output Characteristics ( $T_J = 25^\circ\text{C}$ )**

**Figure 2. Body Diode Forward Voltage**

**Figure 3. Drain Current vs. Temperature**

**Figure 4.  $BV_{DSS}$  Variation vs. Temperature**

**Figure 5. Transfer Characteristics**

**Figure 6. On-Resistance vs. Temperature**

Typical Characteristics  $T_J = 25^\circ\text{C}$ , unless otherwise noted

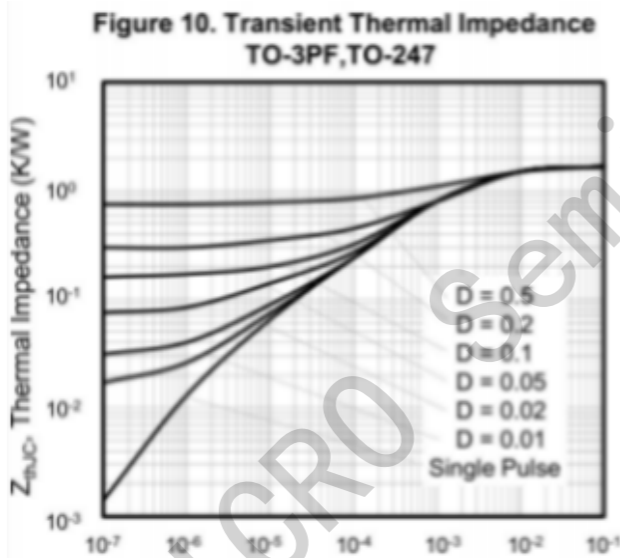
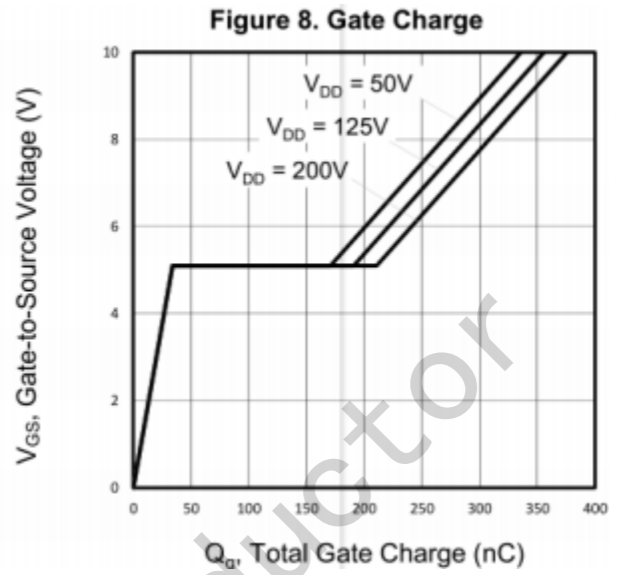

Figure A: Gate Charge Test Circuit and Waveform

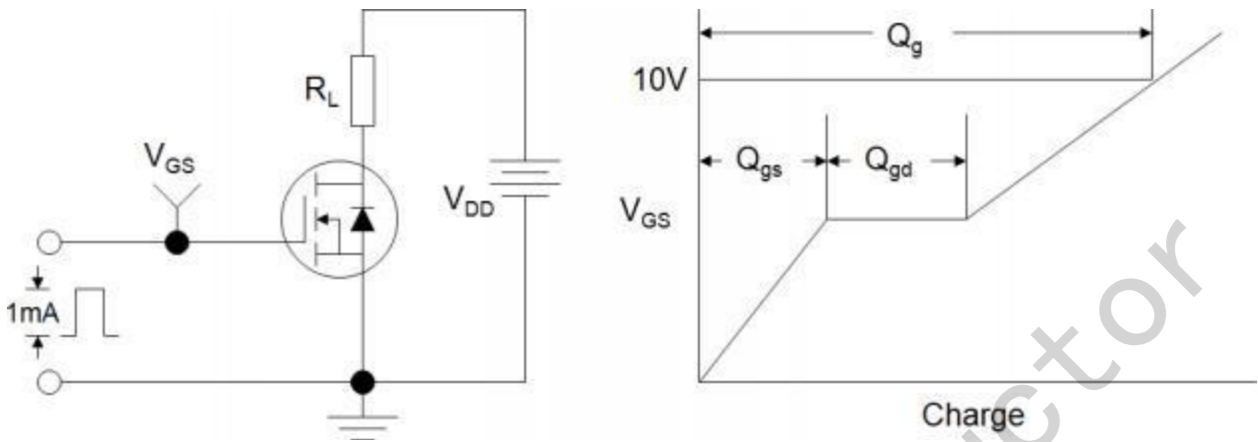

Figure B : Resistive Switching Test Circuit and Waveform

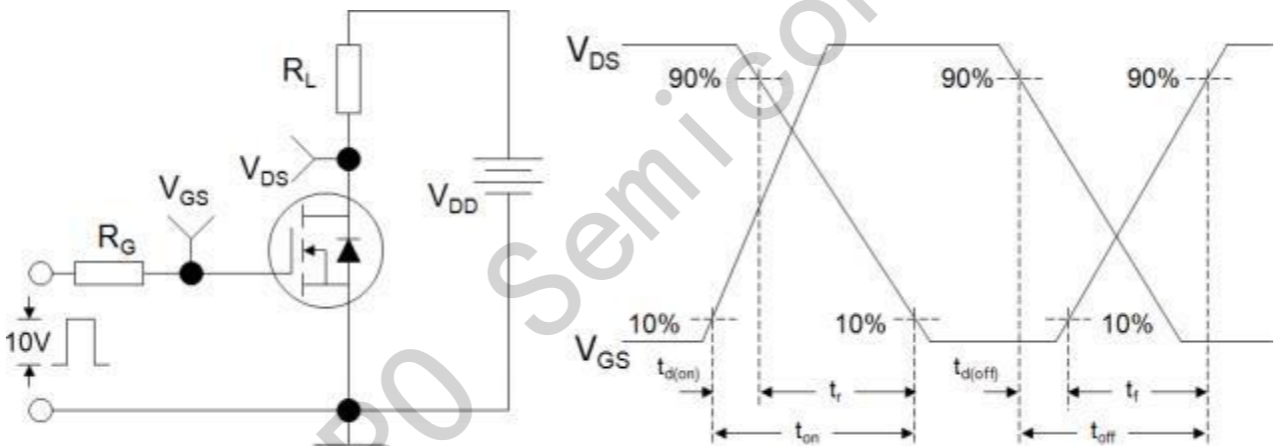
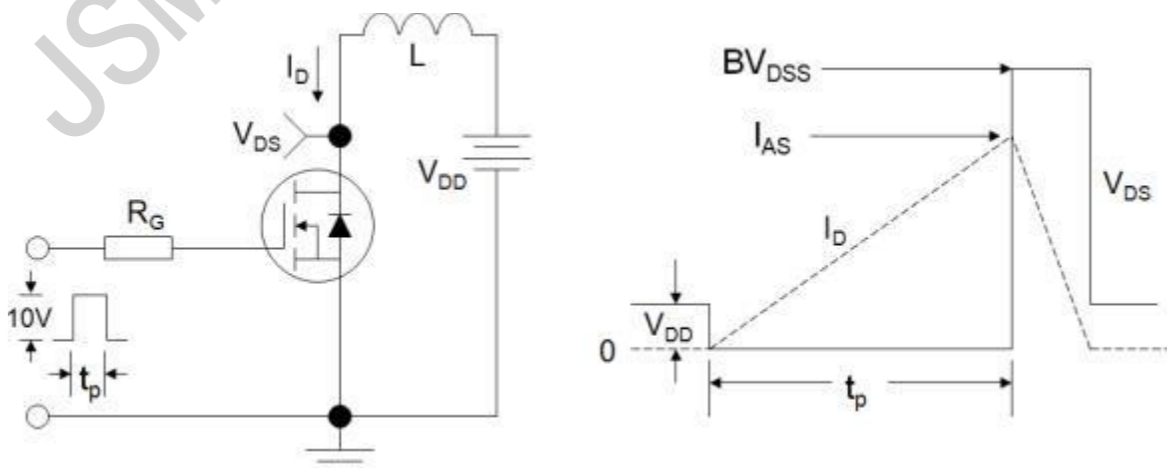
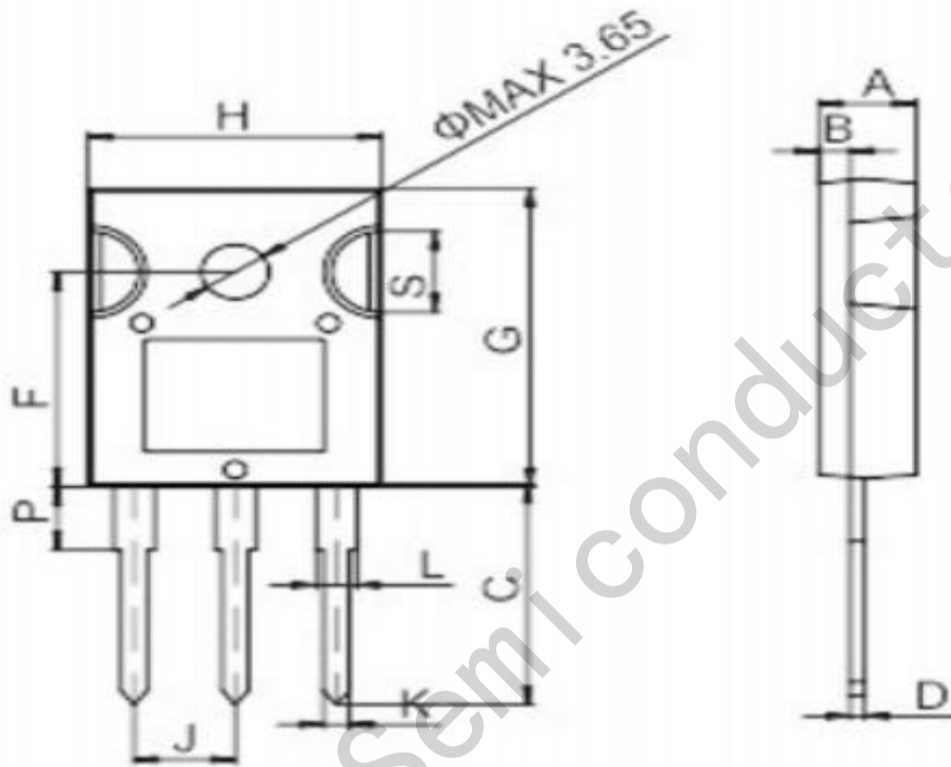

Figure C : Unclamped Inductive Switching Test Circuit and Waveform



**TO-247**



Ref.	Dimensions					
	Millimeters			Inches		
	Min.	Typ.	Max.	Min.	Typ.	Max.
A	4.9		5.4	0.193		0.213
B	1.6		2.0	0.063		0.079
C	14.35		15.4	0.565		0.606
D	0.5		0.8	0.020		0.031
F	14.4		15.1	0.567		0.594
G	19.7		20.6	0.775		0.811
H	15.4		16.2	0.606		0.638
J	5.3		5.6	0.209		0.220
K	1.3		1.5	0.051		0.059
L	2.8		3.3	0.110		0.130
P	3.7		4.2	0.146		0.165
S	5.35		5.65	0.211		0.222

## X-ON Electronics

Largest Supplier of Electrical and Electronic Components

*Click to view similar products for [MOSFET](#) category:*

*Click to view products by [JSMSEMI](#) manufacturer:*

Other Similar products are found below :

[IRFD120](#) [JANTX2N5237](#) [BUK455-60A/B](#) [MIC4420CM-TR](#) [VN1206L](#) [NDP4060](#) [SI4482DY](#) [IPS70R2K0CEAKMA1](#) [SQD23N06-31L-GE3](#)  
[TK16J60W,S1VQ\(O](#) [2SK2614\(TE16L1,Q\)](#) [DMN1017UCP3-7](#) [DMN1053UCP4-7](#) [SQJ469EP-T1-GE3](#) [NTE2384](#) [DMC2700UDMQ-7](#)  
[DMN2080UCB4-7](#) [DMN61D9UWQ-13](#) [US6M2GTR](#) [DMN31D5UDJ-7](#) [DMP22D4UFO-7B](#) [DMN1006UCA6-7](#) [DMN16M9UCA6-7](#)  
[STF5N65M6](#) [IRF40H233XTMA1](#) [STU5N65M6](#) [DMN6022SSD-13](#) [DMN13M9UCA6-7](#) [DMTH10H4M6SPS-13](#) [DMN2990UFB-7B](#)  
[IPB80P04P405ATMA2](#) [2N7002W-G](#) [MCAC30N06Y-TP](#) [MCQ7328-TP](#) [BXP7N65D](#) [BXP4N65F](#) [AOL1454G](#) [WMJ80N60C4](#) [BXP2N20L](#)  
[BXP2N65D](#) [BXT1150N10J](#) [BXT1700P06M](#) [TSM60NB380CP ROG](#) [RQ7L055BGTCR](#) [DMNH15H110SK3-13](#) [SLF10N65ABV2](#)  
[BSO203SP](#) [BSO211P](#) [IPA60R230P6](#) [IPA60R460CE](#)