

FEATURES

- Fast switching
- 100% avalanche tested
- Improved dv/dt capability

APPLICATIONS

- Switch Mode Power Supply (SMPS)
- Uninterruptible Power Supply (UPS)
- Power Factor Correction (PFC)

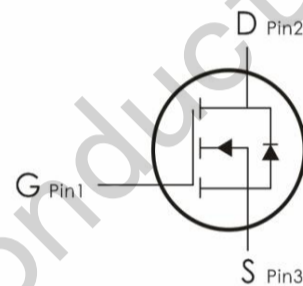
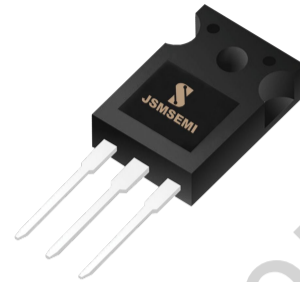

Device Marking and Package Information		
Device	Package	Marking
IRFP9240PBF	TO-247S	IRFP9240

Absolute Maximum Ratings $T_C = 25^\circ\text{C}$, unless otherwise noted			
Parameter	Symbol	Value	Unit
		TO-247	
Drain-Source Voltage ($V_{GS} = 0\text{V}$)	V_{DSS}	-200	V
Continuous Drain Current	I_D	-12	A
Pulsed Drain Current (note1)	I_{DM}	-50	A
Gate-Source Voltage	V_{GSS}	± 20	V
Single Pulse Avalanche Energy (note2)	E_{AS}	165	mJ
Avalanche Current (note1)	I_{AS}	-11	A
Power Dissipation ($T_C = 25^\circ\text{C}$)	P_D	78	mJ
Linear Derating Factor		0.6	W/°C
Operating Junction and Storage Temperature Range	T_J, T_{stg}	-55~+150	°C

Thermal Resistance			
Parameter	Symbol	Value	Unit
		TO-247	
Thermal Resistance, Junction-to-Case	R_{thJC}	1.2	KW
Thermal Resistance, Junction-to-Ambient	R_{thJA}	48	

Specifications $T_J = 25^\circ\text{C}$, unless otherwise noted						
Parameter	Symbol	Test Conditions	Value			Unit
			Min.	Typ.	Max.	
Static						
Drain-Source Breakdown Voltage	$V_{(BR)DSS}$	$V_{GS} = 0V, I_D = 250\mu A$	-200	--	--	V
Zero Gate Voltage Drain Current	I_{DSS}	$V_{DS} = -200V, V_{GS} = 0V, T_J = 25^\circ\text{C}$	--	--	5	μA
Gate-Source Leakage	I_{GSS}	$V_{GS} = \pm 20V$	--	--	± 120	nA
Gate-Source Threshold Voltage	$V_{GS(th)}$	$V_{DS} = V_{GS}, I_D = -250\mu A$	-2	--	-4	V
Drain-Source On-Resistance (Note3)	$R_{DS(on)}$	$V_{GS} = -10V, I_D = -6.6A$	--	0.34	0.42	Ω
Dynamic						
Input Capacitance	C_{iss}	$V_{GS} = 0V,$ $V_{DS} = -25V,$ $f = 1.0\text{MHz}$	--	1200	---	pF
Output Capacitance	C_{oss}		--	370	--	
Reverse Transfer Capacitance	C_{rss}		--	81	--	
Total Gate Charge	Q_g	$V_{DD} = -100V,$ $I_D = -13.5A,$ $V_{GS} = -10V$	--	52	68	nC
Gate-Source Charge	Q_{gs}		--	9	--	
Gate-Drain Charge	Q_{gd}		--	25	--	
Turn-on Delay Time	$t_{d(on)}$	$V_{DD} = -160V, I_D = -13.5A,$ $R_G = 25 \Omega$	--	28	56	ns
Turn-on Rise Time	t_r		--	74	148	
Turn-off Delay Time	$t_{d(off)}$		--	260	520	
Turn-off Fall Time	t_f		--	120	240	
Drain-Source Body Diode Characteristics						
Continuous Body Diode Current	I_S	$T_C = 25^\circ\text{C}$	--	--	-12	A
Pulsed Diode Forward Current	I_{SM}		--	--	-50	
Body Diode Voltage	V_{SD}	$T_J = 25^\circ\text{C}, I_{SD} = -11A, V_{GS} = 0V$	--	--	-5	V
Reverse Recovery Time	t_{rr}	$V_{GS} = 0V, I_S = -11A,$ $di_f/dt = 100A/\mu s$	--	250	300	ns
Reverse Recovery Charge	Q_{rr}		--	2.9	3.6	μC

Notes

1. Repetitive Rating: Pulse width limited by maximum junction temperature
2. $I_{AS} = -11A, V_{DD} = 25V, R_G = 25 \Omega$, Starting $T_J = 25^\circ\text{C}$
3. Pulse Test: Pulse width $\leq 300\mu s$, Duty Cycle $\leq 1\%$

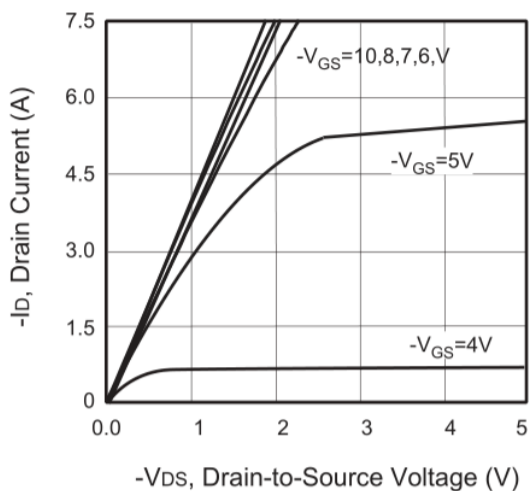
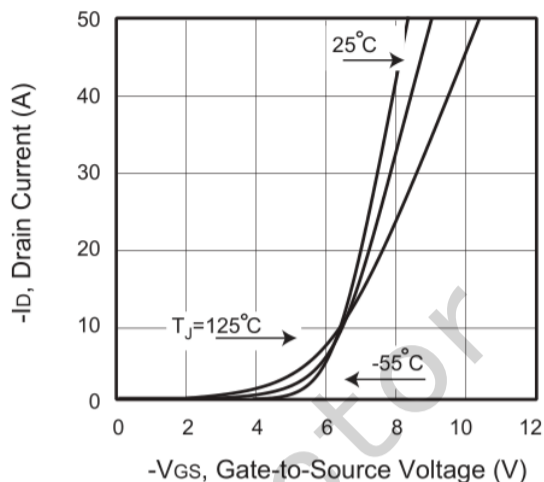
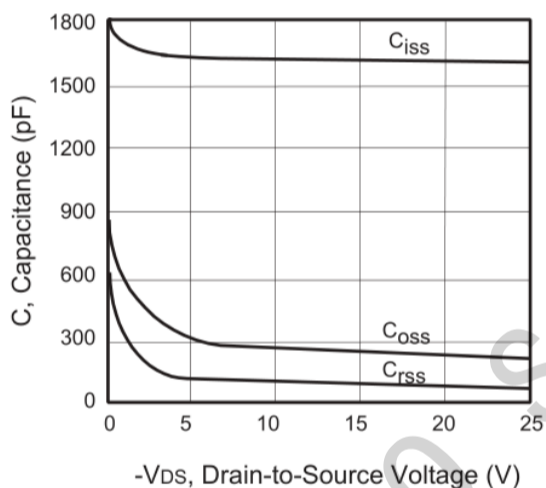
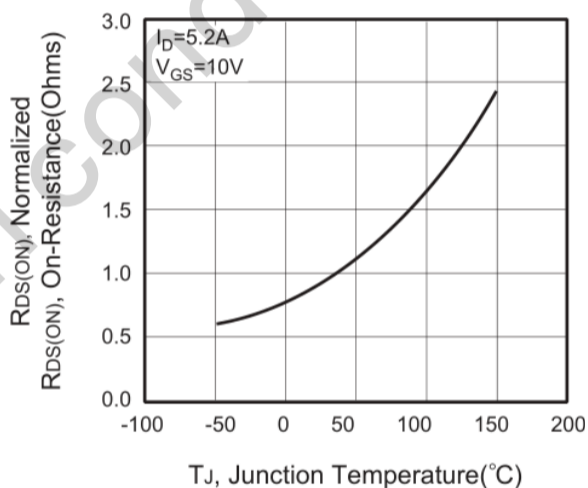
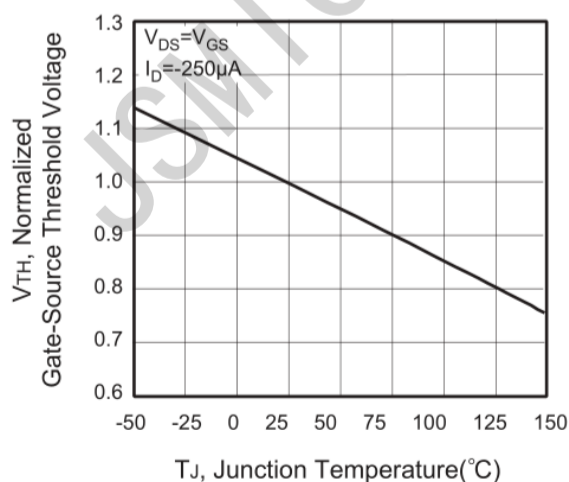
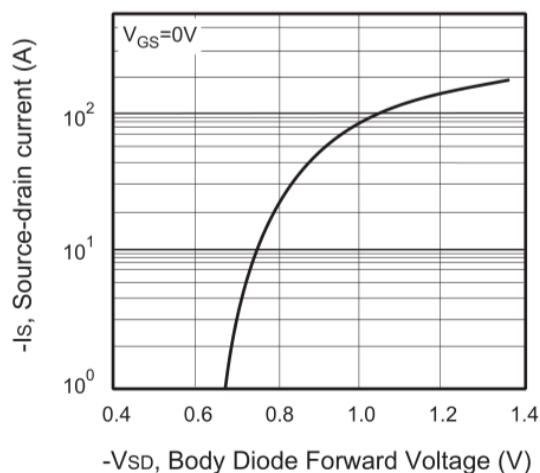
Figure 1. Output Characteristics

Figure 2. Transfer Characteristics

Figure 3. Capacitance

Figure 4. On-Resistance Variation with Temperature

Figure 5. Gate Threshold Variation with Temperature

Figure 6. Body Diode Forward Voltage Variation with Source Current

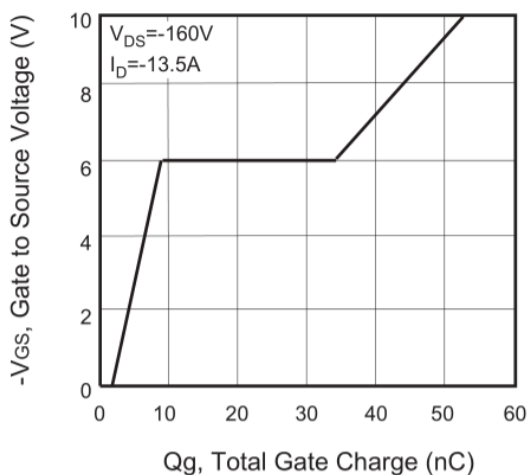

Figure 7. Gate Charge

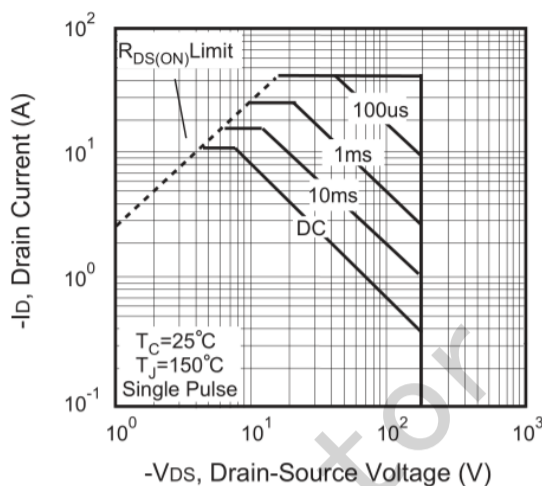

Figure 8. Maximum Safe Operating Area

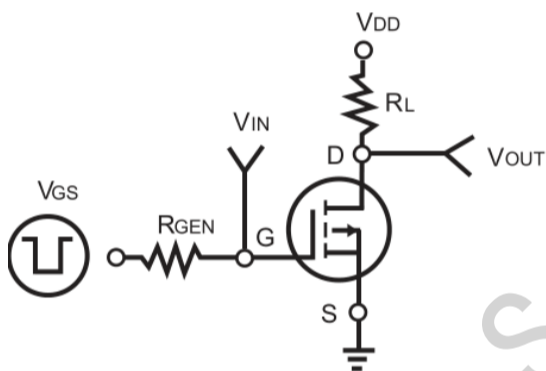

Figure 9. Switching Test Circuit

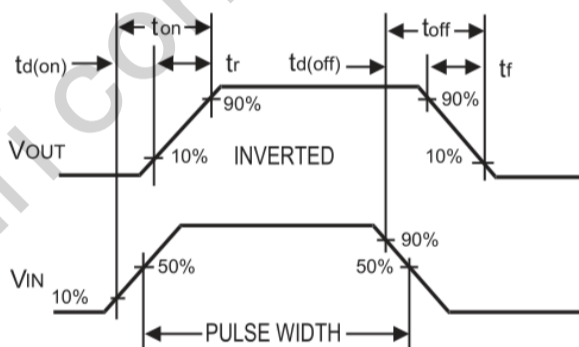

Figure 10. Switching Waveforms

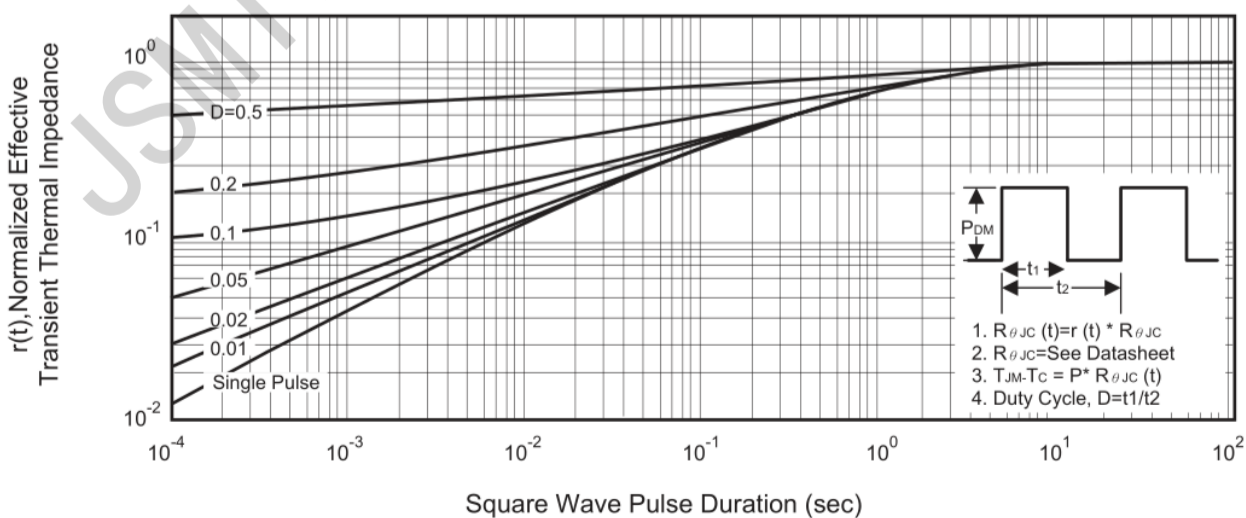
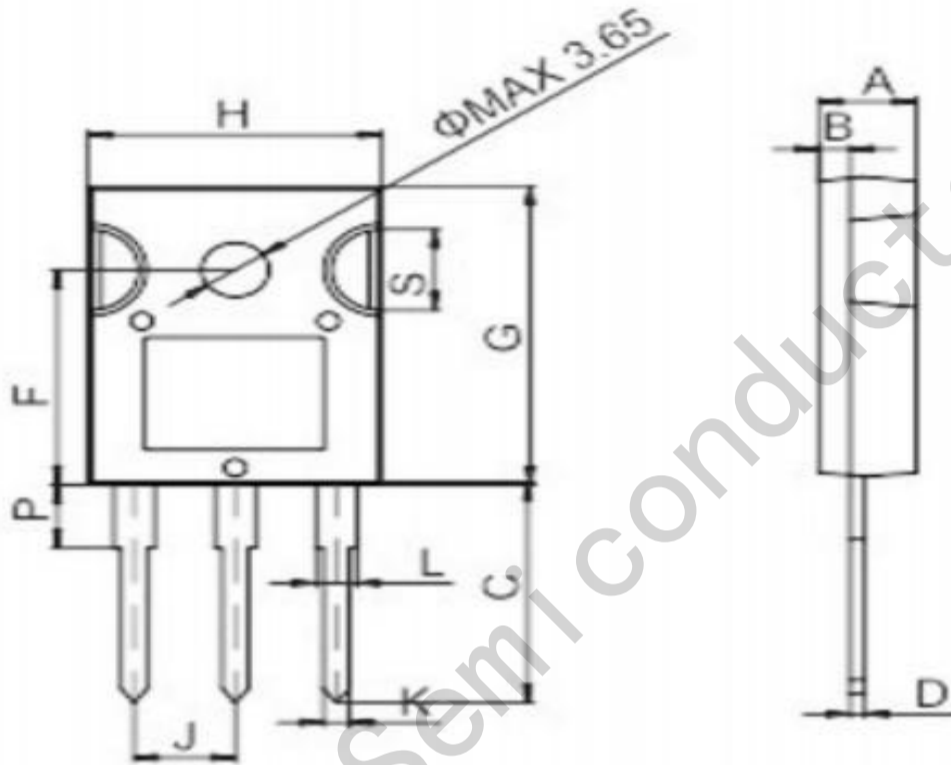

Figure 11. Normalized Thermal Transient Impedance Curve

TO-247



Ref.	Dimensions					
	Millimeters			Inches		
	Min.	Typ.	Max.	Min.	Typ.	Max.
A	4.9		5.4	0.193		0.213
B	1.6		2.0	0.063		0.079
C	14.35		15.4	0.565		0.606
D	0.5		0.8	0.020		0.031
F	14.4		15.1	0.567		0.594
G	19.7		20.6	0.775		0.811
H	15.4		16.2	0.606		0.638
J	5.3		5.6	0.209		0.220
K	1.3		1.5	0.051		0.059
L	2.8		3.3	0.110		0.130
P	3.7		4.2	0.146		0.165
S	5.35		5.65	0.211		0.222

X-ON Electronics

Largest Supplier of Electrical and Electronic Components

Click to view similar products for [MOSFET](#) category:

Click to view products by [JSMSEMI](#) manufacturer:

Other Similar products are found below :

[IRFD120](#) [IRFY240C](#) [JANTX2N5237](#) [2SK2267\(Q\)](#) [BUK455-60A/B](#) [MIC4420CM-TR](#) [VN1206L](#) [NDP4060](#) [SI4482DY](#)
[IPS70R2K0CEAKMA1](#) [SQD23N06-31L-GE3](#) [TK16J60W,S1VQ\(O](#) [2SK2614\(TE16L1,Q\)](#) [DMN1017UCP3-7](#) [EFC2J004NUZTDG](#)
[DMN1053UCP4-7](#) [SQJ469EP-T1-GE3](#) [NTE2384](#) [DMC2700UDMQ-7](#) [DMN2080UCB4-7](#) [DMN61D9UWQ-13](#) [US6M2GTR](#)
[DMN31D5UDJ-7](#) [DMP22D4UFO-7B](#) [DMN1006UCA6-7](#) [DMN16M9UCA6-7](#) [STF5N65M6](#) [IRF40H233XTMA1](#) [STU5N65M6](#)
[DMN6022SSD-13](#) [DMN13M9UCA6-7](#) [DMTH10H4M6SPS-13](#) [DMN2990UFB-7B](#) [IPB80P04P405ATMA2](#) [2N7002W-G](#) [MCAC30N06Y-](#)
[TP](#) [MCQ7328-TP](#) [NTMC083NP10M5L](#) [NVMFS2D3P04M8LT1G](#) [BXP7N65D](#) [BXP4N65F](#) [AOL1454G](#) [WMJ80N60C4](#) [BXP2N20L](#)
[BXP2N65D](#) [BXT1150N10J](#) [BXT1700P06M](#) [TSM60NB380CP](#) [ROG](#) [RQ7L055BGTCR](#) [DMNH15H110SK3-13](#)