

FEATURE

- ◆ -20V/-4.3A, $R_{DS(ON)}=30m\Omega$ (typ.)@ $V_{GS}=-4.5V$
- ◆ -20V/-3.5A, $R_{DS(ON)}=40m\Omega$ (typ.)@ $V_{GS}=-2.5V$
- ◆ -20V/-2.0A, $R_{DS(ON)}=56m\Omega$ (typ.)@ $V_{GS}=-1.8V$
- ◆ -20V/-1.0A, $R_{DS(ON)}=85m\Omega$ (typ.)@ $V_{GS}=-1.5V$
- ◆ Super high design for extremely low $R_{DS(ON)}$
- ◆ Exceptional on-resistance and Maximum DC current capability
- ◆ Full RoHS compliance
- ◆ SOT23-3 package design

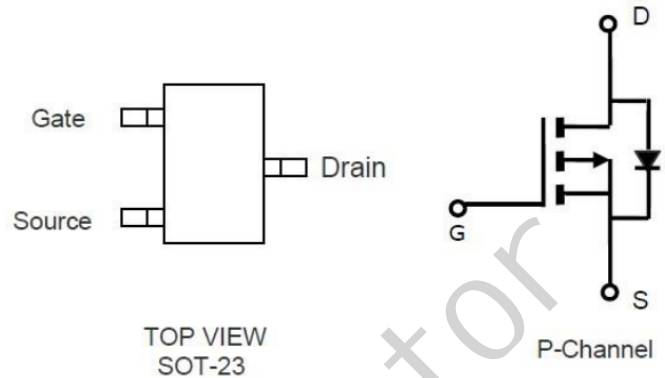

DESCRIPTION

The IRLML2244TRPBF is the P-Channel logic enhancement mode power field effect transistor is produced using high cell density advanced trench technology.

This high density process is especially tailored to minimize on-state resistance. These devices are particularly suited for low voltage application, and low in-line power loss are needed in a very small outline surface mount package.

APPLICATIONS

- ◆ Power Management
- ◆ Portable Equipment
- ◆ DC/DC Converter
- ◆ Load Switch
- ◆ DSC
- ◆ LCD Display inverter

ABSOLUTE MAXIMUM RATINGS ($T_A = 25^\circ\text{C}$ Unless otherwise noted)

Symbol	Parameter		Typical	Unit
V_{DSS}	Drain-Source Voltage		-20	V
V_{GSS}	Gate-Source Voltage		± 10	V
I_D	Continuous Drain Current ($T_C=25^\circ\text{C}$)	$V_{GS}=-10V$	-4.2	A
	Continuous Drain Current ($T_C=70^\circ\text{C}$)		-3.5	A
I_{DM}	Pulsed Drain Current		-20	A
P_D	Power Dissipation	$T_A=25^\circ\text{C}$	1.5	W
		$T_A=70^\circ\text{C}$	0.9	
T_J	Operation Junction Temperature		150	$^\circ\text{C}$
T_{STG}	Storage Temperature Range		-55~+150	$^\circ\text{C}$
$R_{\theta JA}$	Thermal Resistance Junction to Ambient		120	$^\circ\text{C/W}$

Note: Absolute maximum ratings are those values beyond which the device could be permanently damaged. Absolute maximum ratings are stress rating only and functional device operation is not implied

ELECTRICAL CHARACTERISTICS ($T_A=25^\circ\text{C}$ Unless otherwise noted)

Symbol	Parameter	Condition	Min	Typ	Max	Unit
Static Parameters						
$V_{(BR)DSS}$	Drain-Source Breakdown Voltage	$V_{GS}=0V, I_D=-250\mu A$	-20			V
$V_{GS(th)}$	Gate Threshold Voltage	$V_{DS}=V_{GS}, I_D=-250\mu A$	-0.3		-1.0	V
I_{GSS}	Gate Leakage Current	$V_{DS}=0V, V_{GS}=\pm 10V$			± 100	nA
I_{DSS}	Zero Gate Voltage Drain Current	$V_{DS}=-20V, V_{GS}=0$			-1	uA
		$V_{DS}=-20V, V_{GS}=0$ $T_J=55^\circ\text{C}$			-5	
$R_{DS(ON)}$	Drain-Source On-Resistance	$V_{GS}=-4.5V, I_D=-4.0A$		30	40	mΩ
		$V_{GS}=-2.5V, I_D=-4.0A$		40	60	
		$V_{GS}=-1.8V, I_D=-2.0A$		56	78	
		$V_{GS}=-1.5V, I_D=-1.0A$		85	110	
Gfs	Forward Transconductance	$V_{DS}=-5V, I_D=-4.0A$		22		S
Source-Drain Diode						
V_{SD}	Diode Forward Voltage	$I_S=-1.0A, V_{GS}=0V$		-0.67	-1.2	V
Dynamic Parameters						
Q_g	Total Gate Charge	$V_{DS}=-10V$		11.1		nC
Q_{gs}	Gate-Source Charge	$V_{GS}=-4.5V$		3.1		
Q_{gd}	Gate-Drain Charge	$I_D=-4.0A$		2.4		
C_{iss}	Input Capacitance	$V_{DS}=-10V$		989		pF
C_{oss}	Output Capacitance	$V_{GS}=0V$		167		
C_{riss}	Reverse Transfer Capacitance	$f=1\text{MHz}$		75.5		
$T_{d(on)}$	Turn-On Time	$V_{DS}=-10V$		712		nS
T_r		$I_D=-3.7A$		1386		
$T_{d(off)}$	Turn-Off Time	$V_{GEN}=-4.5V$		9.1		
T_f		$R_G=1\Omega$		4		

Note: 1. Pulse test: pulse width $\leq 300\mu\text{s}$, duty cycle $\leq 2\%$

2. Static parameters are based on package level with recommended wire bonding

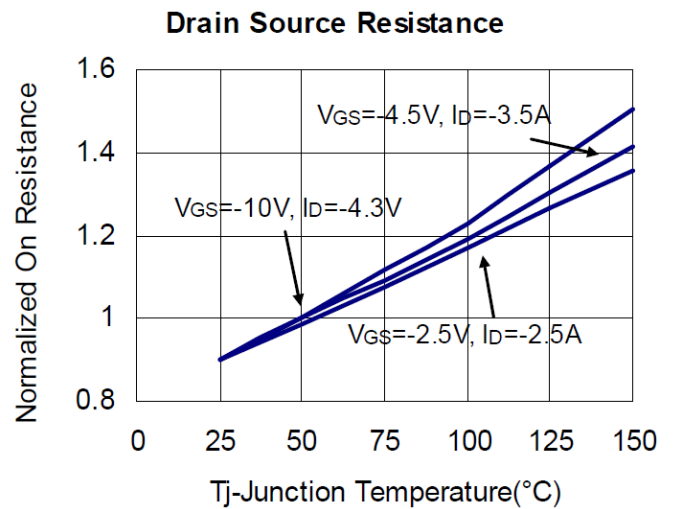
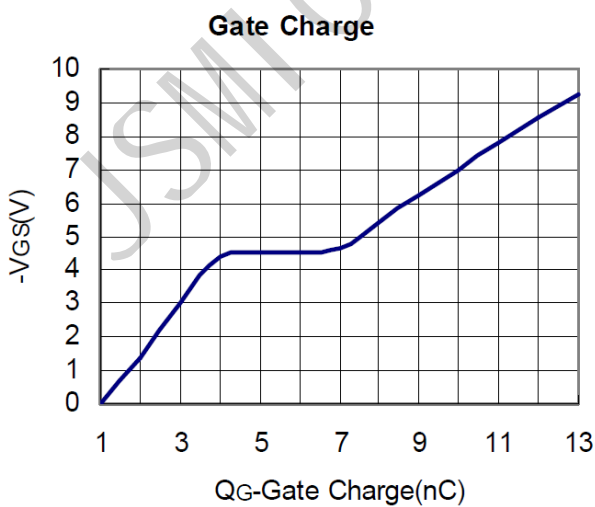
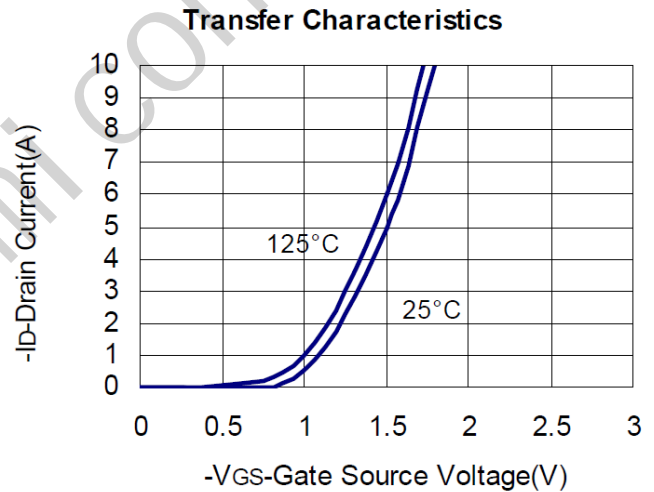
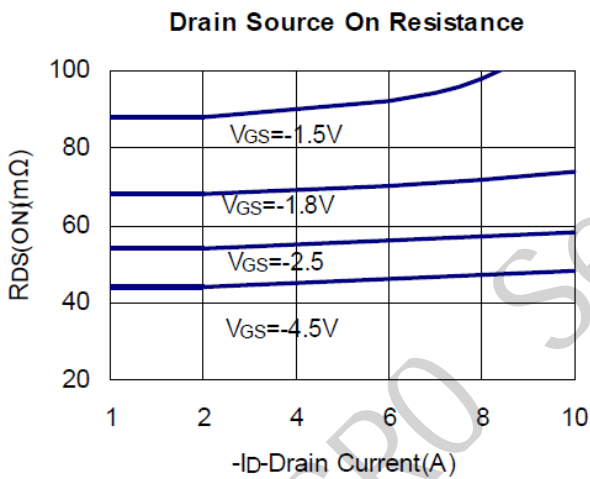
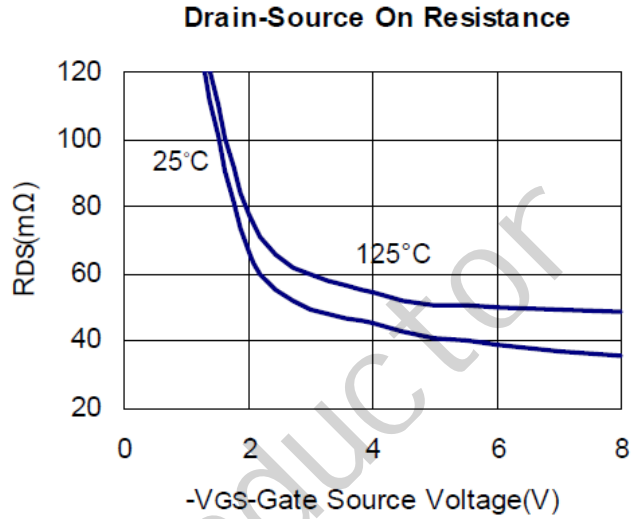
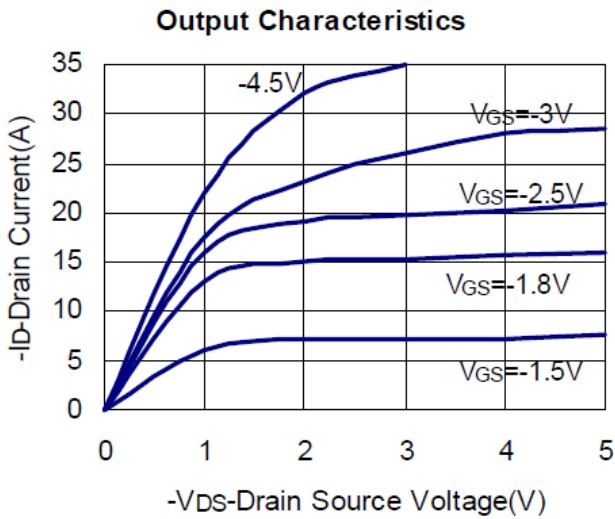
TYPICAL CHARACTERISTICS (25°C Unless Note)

■ **TYPICAL CHARACTERISTICS** (continuous)

Capacitance

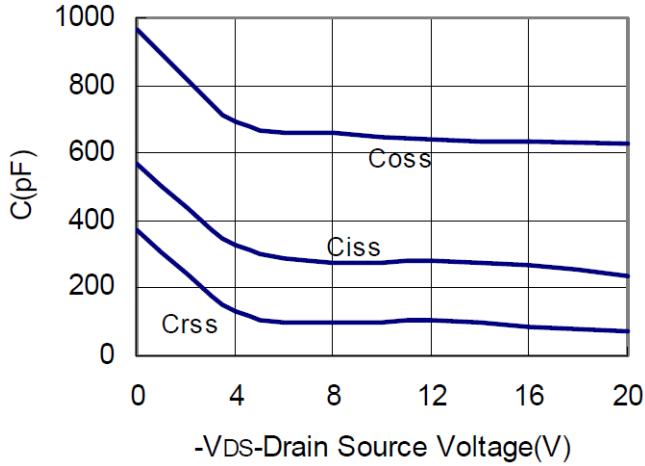

Source Drain Diode Forward

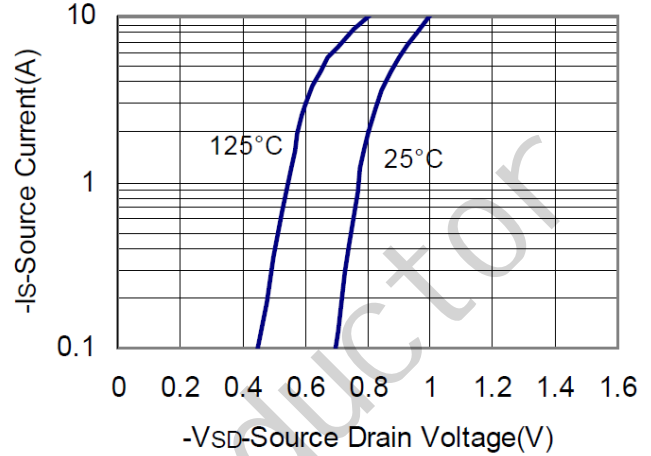

Power Dissipation

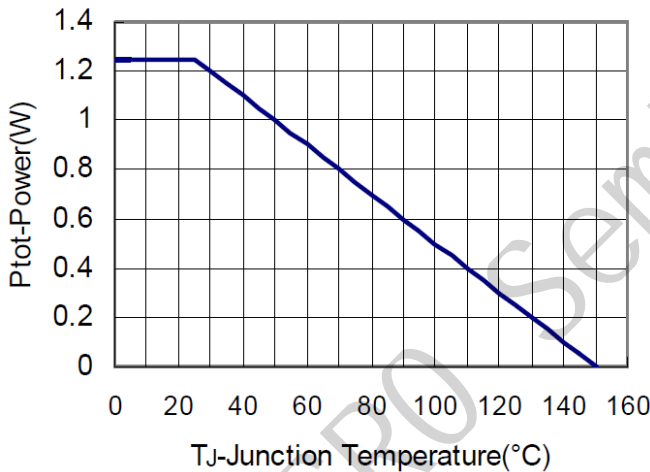

Drain Current

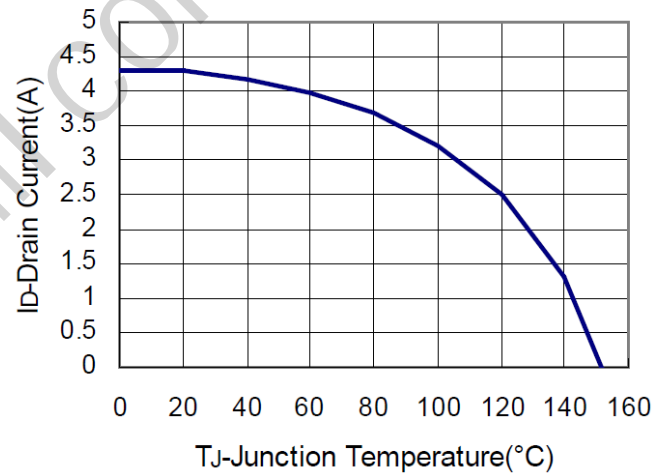

Thermal Transient Impedance

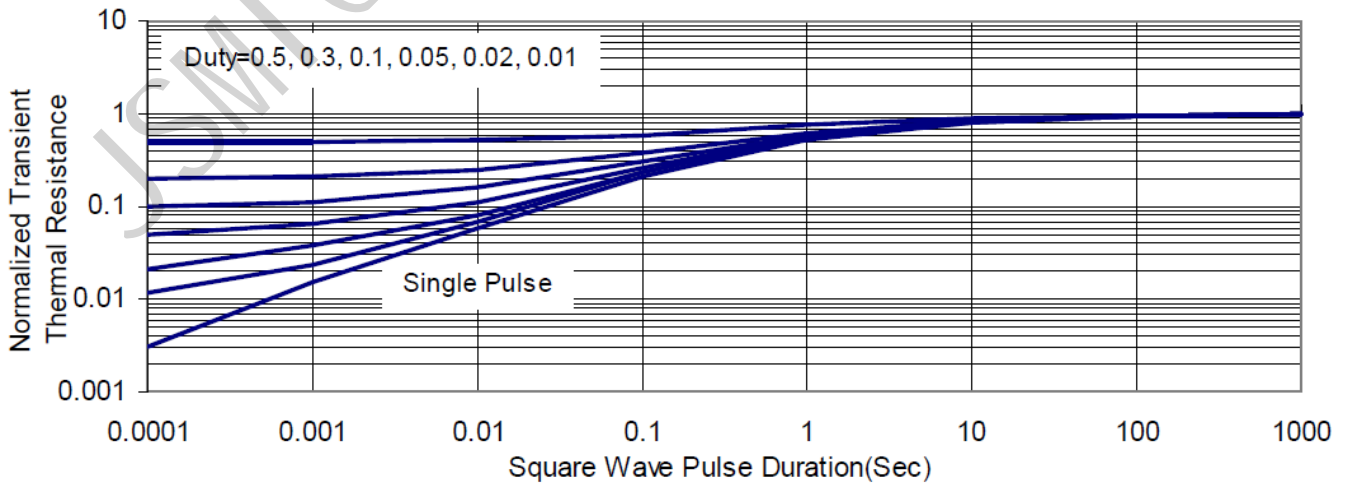

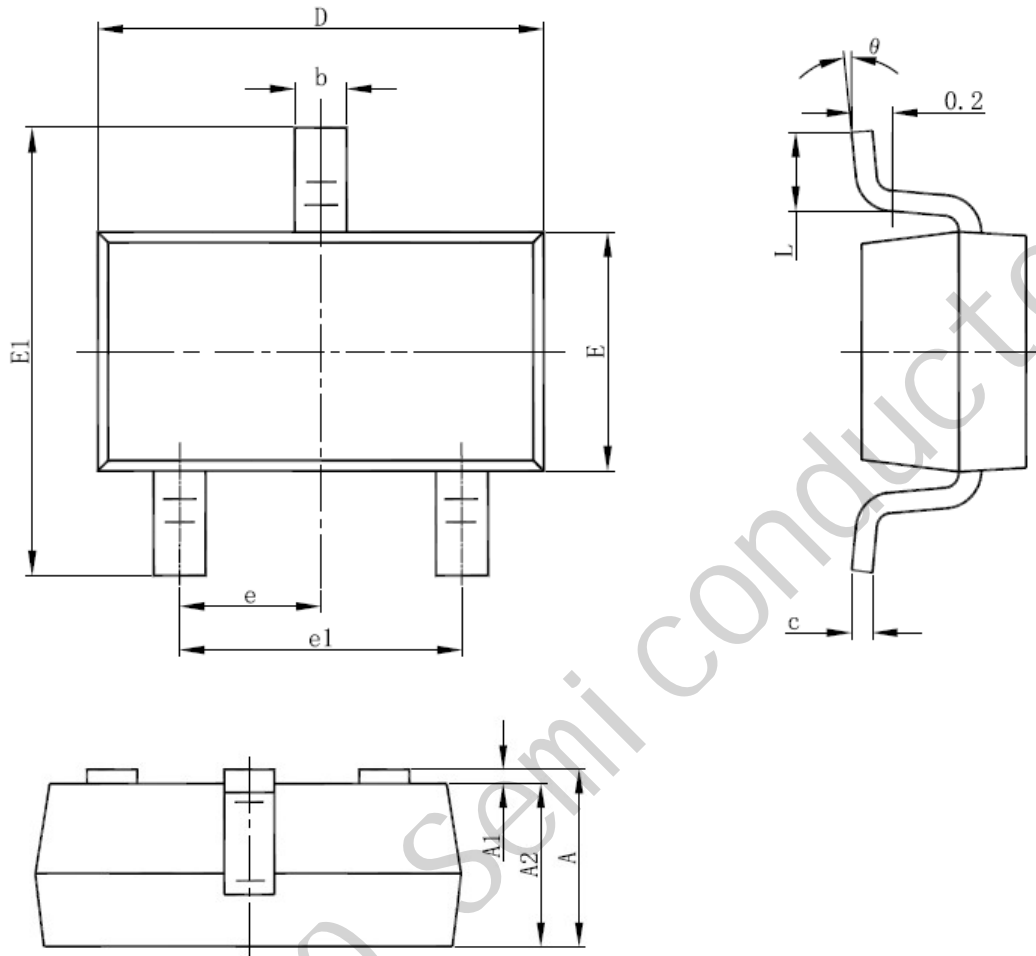
■ SOT23 PACKAGE OUTLINE DIMENSIONS

Symbol	Dimensions In Millimeters		Dimensions In Inches	
	Min	Max	Min	Max
A	1.050	1.250	0.041	0.049
A1	0.000	0.100	0.000	0.004
A2	1.050	1.150	0.041	0.045
b	0.300	0.500	0.012	0.020
c	0.100	0.200	0.004	0.008
D	2.820	3.020	0.111	0.119
E	1.500	1.700	0.059	0.067
E1	2.650	2.950	0.104	0.116
e	0.950(BSC)		0.037(BSC)	
e1	1.800	2.000	0.071	0.079
L	0.300	0.600	0.012	0.024
θ	0°	8°	0°	8°

X-ON Electronics

Largest Supplier of Electrical and Electronic Components

Click to view similar products for [MOSFET](#) category:

Click to view products by [JSMSEMI](#) manufacturer:

Other Similar products are found below :

[IRFD120](#) [JANTX2N5237](#) [BUK455-60A/B](#) [MIC4420CM-TR](#) [VN1206L](#) [NDP4060](#) [SI4482DY](#) [IPS70R2K0CEAKMA1](#) [SQD23N06-31L-GE3](#)
[TK16J60W,S1VQ\(O](#) [2SK2614\(TE16L1,Q\)](#) [DMN1017UCP3-7](#) [DMN1053UCP4-7](#) [SQJ469EP-T1-GE3](#) [NTE2384](#) [DMC2700UDMQ-7](#)
[DMN2080UCB4-7](#) [DMN61D9UWQ-13](#) [US6M2GTR](#) [DMN31D5UDJ-7](#) [DMP22D4UFO-7B](#) [DMN1006UCA6-7](#) [DMN16M9UCA6-7](#)
[STF5N65M6](#) [IRF40H233XTMA1](#) [STU5N65M6](#) [DMN6022SSD-13](#) [DMN13M9UCA6-7](#) [DMTH10H4M6SPS-13](#) [DMN2990UFB-7B](#)
[IPB80P04P405ATMA2](#) [2N7002W-G](#) [MCAC30N06Y-TP](#) [MCQ7328-TP](#) [BXP7N65D](#) [BXP4N65F](#) [AOL1454G](#) [WMJ80N60C4](#) [BXP2N20L](#)
[BXP2N65D](#) [BXT1150N10J](#) [BXT1700P06M](#) [TSM60NB380CP](#) [ROG](#) [RQ7L055BGTCR](#) [DMNH15H110SK3-13](#) [SLF10N65ABV2](#)
[BSO203SP](#) [BSO211P](#) [IPA60R230P6](#) [IPA60R460CE](#)