

描述 / Descriptions

SOT-23 塑封封装 N 沟道 MOS 场效应管。
 N- CHANNEL MOSFET in a SOT-23 Plastic Package.

特征 / Features

芯片采用超高密度圆胞设计技术， $R_{DS(ON)}$ 导通电阻小，SOT-23 封装。
 Super high dense cell design for low $R_{DS(ON)}$, SOT-23 package.

用途 / Applications

电池管理，高速开关，低功率 DC-DC 转换。
 Battery management, High speed switch, low power DC to DC converter.



PIN1 : G

PIN 2 : S

PIN 3 : D

印章代码 / Marking

Marking	A2SHB
---------	-------

极限参数 / Absolute Maximum Ratings(Ta=25°C)

参数 Parameter	符号 Symbol	数值 Rating	单位 Unit
Drain-Source Voltage	V_{DSS}	20	V
Gate-Source Voltage	V_{GSS}	±8	V
Drain Current – Continuous	I_D	3.0	A
Pulsed Drain Current	I_{DM}	10	A
Continuous Source Current	I_S	0.95	A
Power Dissipation	P_D	0.9	W
Storage Temperature Range	T_{stg}	-55~150	°C

电性能参数 / Electrical Characteristics(Ta=25°C)

参数 Parameter	符号 Symbol	测试条件 Test Conditions	最小值 Min	典型值 Typ	最大值 Max	单位 Unit
Drain-Source Breakdown Voltage	$V_{(BR)DSS}$	$V_{GS}=0$ $I_D=10\mu A$	20			V
Zero Gate Voltage Drain Current	I_{DSS}	$V_{GS}=0$ $V_{DS}=20V$			1.0	μA
Gate-Body Leakage.	I_{GSS}	$V_{GS}=\pm 8V$ $V_{DS}=0V$			± 100	nA
Static Drain-Source On-Resistance	$R_{DS(on)1}$	$V_{GS}=4.5V$ $I_D=3.6A$			60	m Ω
	$R_{DS(on)2}$	$V_{GS}=2.5V$ $I_D=3.1A$			115	m Ω
Forward Transconductance	g_{FS}	$V_{DS}=5V$ $I_D=3.6A$		8		S
Drain-Source Diode Forward Voltage	V_{SD}	$V_{GS}=0V$ $I_D=1.25A$		0.75	1.2	V
Gate Threshold Voltage	$V_{GS(th)}$	$V_{DS}=V_{GS}$ $I_D=50\mu A$	0.50		1.0	V
State Drain Current	$I_{D(on)}$	$V_{DS}=5V$ $V_{GS}=2.5V$	4			A
Turn-On Delay Time	$t_{d(on)}$	$V_{DD}=10V$ $I_D=3.6A$ $V_{GEN}=4.5V$ $R_{GEN}=6\Omega$ $R_L=2.8\Omega$		7		ns
Turn-On Rise Time	t_r			55		
Turn-Off Delay Time	$t_{d(off)}$			15		
Turn-Off Fall Time	t_f			10		

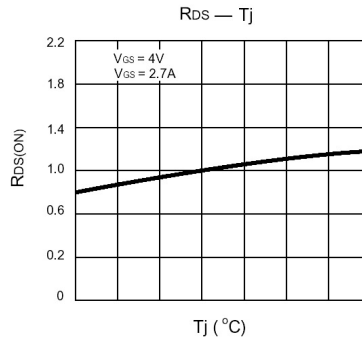
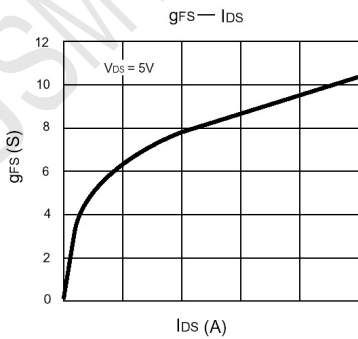
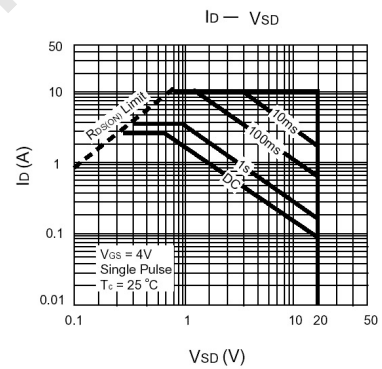
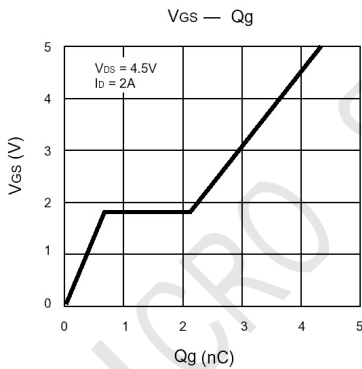
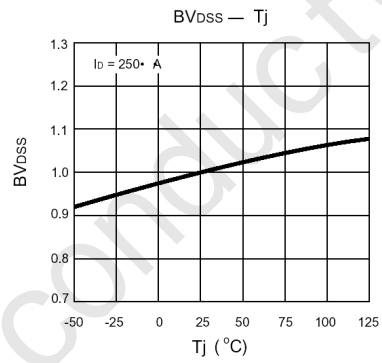
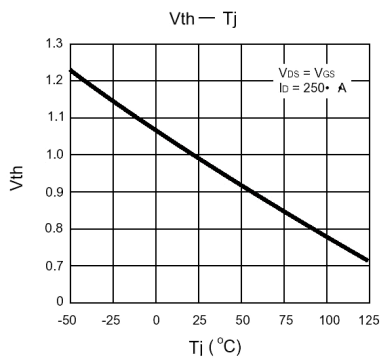
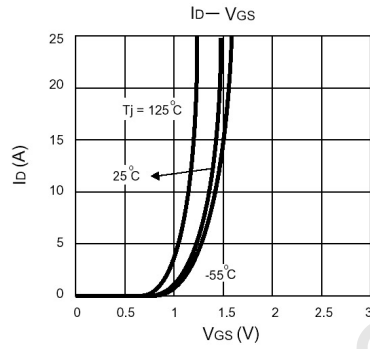
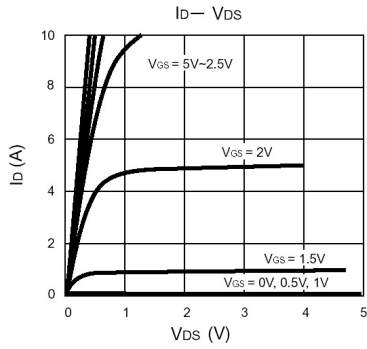
电参数曲线图 / Electrical Characteristic Curve

外形尺寸图 / Package Dimensions

SOT-23

单位: mm

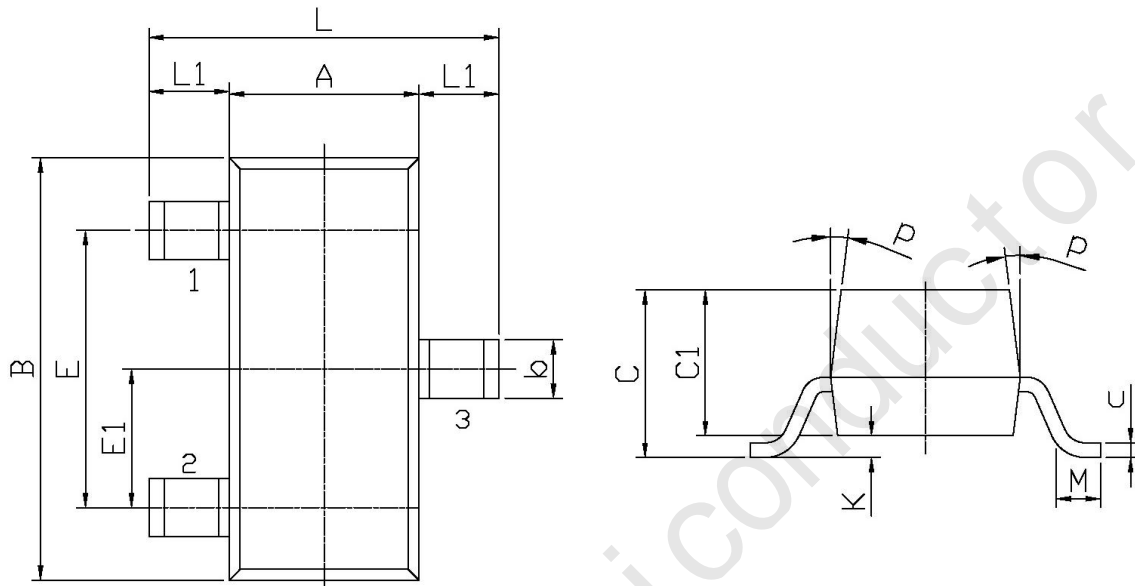

Symbol	Dimensions In Millimeters		Symbol	Dimensions In Millimeters	
	Min	Max		Min	Max
L	2.2	2.7	C	1.30Max	
L1	0.45	0.65	C1	0.90	1.20
A	1.15	1.50	c	0.05	0.20
B	2.70	3.10	K	0	0.10
E	1.70	2.10	M	0.20MIN	
E1	0.85	1.05	P	7°	
b	0.35	0.55			

X-ON Electronics

Largest Supplier of Electrical and Electronic Components

Click to view similar products for [MOSFET](#) category:

Click to view products by [JSMSEMI](#) manufacturer:

Other Similar products are found below :

[614233C](#) [648584F](#) [NTNS3A92PZT5G](#) [IRFD120](#) [IRFF430](#) [JANTX2N5237](#) [2N7000](#) [2SK2464-TL-E](#) [FCA20N60_F109](#) [FDZ595PZ](#) [AOD464](#)
[2SK2267\(Q\)](#) [2SK2545\(Q,T\)](#) [405094E](#) [423220D](#) [MIC4420CM-TR](#) [VN1206L](#) [614234A](#) [715780A](#) [SSM6J414TU,LF\(T](#) [751625C](#)
[IPP60R600P6XKSA1](#) [RJK60S5DPK-M0#T0](#) [BSC884N03MS G](#) [BSF024N03LT3 G](#) [PSMN4R2-30MLD](#) [TK31J60W5,S1VQ\(O](#)
[2SK2614\(Te16L1,Q\)](#) [DMN1017UCP3-7](#) [EFC2J004NUZTDG](#) [FCAB21350L1](#) [P85W28HP2F-7071](#) [DMN1053UCP4-7](#) [NTE2384](#) [NTE2969](#)
[NTE6400A](#) [DMN2080UCB4-7](#) [DMN61D9UWQ-13](#) [US6M2GTR](#) [DMN31D5UDJ-7](#) [SSM6P54TU,LF](#) [DMP22D4UFO-7B](#)
[IPS60R3K4CEAKMA1](#) [DMN1006UCA6-7](#) [DMN16M9UCA6-7](#) [STF5N65M6](#) [STU5N65M6](#) [C3M0021120D](#) [DMN13M9UCA6-7](#)
[BSS340NWH6327XTSA1](#)