

### Description:

This P-Channel MOSFET uses advanced trench technology and design to provide excellent  $R_{DS(on)}$  with low gate charge.

It can be used in a wide variety of applications.

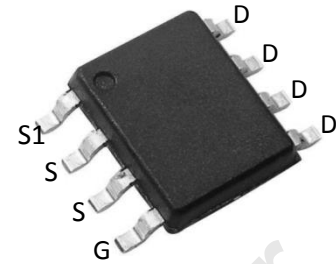

### Features:

- 1)  $V_{DS}=-30V, I_D=-10A, R_{DS(ON)}<20m\ \Omega @V_{GS}=-10V$
- 2) Low gate charge.
- 3) Green device available.
- 4) Advanced high cell density trench technology for ultra  $R_{DS(ON)}$ .
- 5) Excellent package for good heat dissipation.

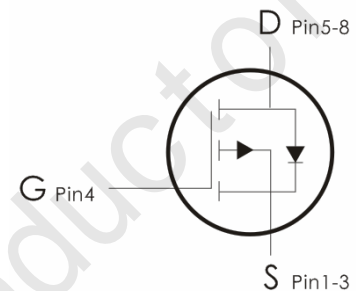

### Absolute Maximum Ratings: ( $T_C=25^\circ C$ unless otherwise noted)

| Symbol         | Parameter  | Ratings     | Units      |
|----------------|--|-------------|------------|
| $V_{DS}$       | Drain-Source Voltage                             | -30         | V          |
| $V_{GS}$       | Gate-Source Voltage                              | $\pm 20$    | V          |
| $I_D$          | Continuous Drain Current- $T_C=25^\circ C$       | -10         | A          |
|                | Continuous Drain Current- $T_C=100^\circ C$      | -5.1        |            |
|                | Pulsed Drain Current <sup>1</sup>                | -32         |            |
| $E_{AS}$       | Single Pulse Avalanche Energy                    | ---         | mJ         |
| $P_D$          | Power Dissipation( $T_C=25^\circ C$ )            | 2.1         | W          |
| $T_J, T_{STG}$ | Operating and Storage Junction Temperature Range | -55 to +150 | $^\circ C$ |

### Thermal Characteristics:

| Symbol          | Parameter                               | Max | Units        |
|-----------------|---|-----|--------------|
| $R_{\theta JC}$ | Thermal Resistance, Junction to Case    | --- | $^\circ C/W$ |
| $R_{\theta JA}$ | Thermal Resistance, Junction to Ambient | 60  |              |

**Electrical Characteristics:** ( $T_C=25^\circ\text{C}$  unless otherwise noted)

| Symbol                                    | Parameter                                       | Conditions                                     | Min  | Typ  | Max       | Units         |
|---|---|--|------|------|-----------|---------------|
| <b>Off Characteristics</b>                |   |  |      |      |           |               |
| $BV_{DSS}$                                | Drain-Source Breakdown Voltage                  | $V_{GS}=0V, I_D=-250\ \mu\text{A}$             | -30  | ---  | ---       | V             |
| $I_{DSS}$                                 | Zero Gate Voltage Drain Current                 | $V_{DS}=-30V, V_{GS}=0V, T_J=25^\circ\text{C}$ | ---  | ---  | -1        | $\mu\text{A}$ |
| $I_{GSS}$                                 | Gate-Source Leakage Current                     | $V_{GS}=\pm 20V, V_{DS}=0A$                    | ---  | ---  | $\pm 100$ | nA            |
| <b>On Characteristics</b>                 |   |  |      |      |           |               |
| $V_{GS(th)}$                              | GATE-Source Threshold Voltage                   | $V_{GS}=V_{DS}, I_D=-250\ \mu\text{A}$         | -1.0 | -1.6 | -2.5      | V             |
| $R_{DS(ON)}$                              | Drain-Source On Resistance <sup>2</sup>         | $V_{GS}=-10V, I_D=-8A$                         | ---  | 16.5 | 20        | m $\Omega$    |
|   |   | $V_{GS}=-4.5V, I_D=-5A$                        | ---  | 25.6 | 32        |               |
| $G_{FS}$                                  | Forward Transconductance                        | $V_{DS}=-10V, I_D=-3A$                         | ---  | 6.8  | ---       | S             |
| <b>Dynamic Characteristics</b>            |   |  |      |      |           |               |
| $C_{iss}$                                 | Input Capacitance                               | $V_{DS}=-15V, V_{GS}=0V, f=1\text{MHz}$        | ---  | 1250 | 1820      | pF            |
| $C_{oss}$                                 | Output Capacitance                              |  | ---  | 160  | 235       |               |
| $C_{rss}$                                 | Reverse Transfer Capacitance                    |  | ---  | 90   | 130       |               |
| <b>Switching Characteristics</b>          |   |  |      |      |           |               |
| $t_{d(on)}$                               | Turn-On Delay Time <sup>2,3</sup>               | $V_{DD}=-15V, V_{GS}=-10V, R_G=6, I_D=-1A$     | ---  | 5.8  | 11        | ns            |
| $t_r$                                     | Rise Time <sup>2,3</sup>                        |  | ---  | 18.8 | 36        | ns            |
| $t_{d(off)}$                              | Turn-Off Delay Time <sup>2,3</sup>              |  | ---  | 46.9 | 89        | ns            |
| $t_f$                                     | Fall Time <sup>2,3</sup>                        |  | ---  | 12.3 | 23        | ns            |
| $Q_g$                                     | Total Gate Charge <sup>2,3</sup>                | $V_{DS}=-15V, V_{GS}=-4.5V, I_D=-5A$           | ---  | 11   | 17        | nC            |
| $Q_{gs}$                                  | Gate-Source Charge <sup>2,3</sup>               |  | ---  | 3.4  | 6         | nC            |
| $Q_{gd}$                                  | Gate-Drain "Miller" Charge <sup>2,3</sup>       |  | ---  | 4.2  | 8         | nC            |
| <b>Drain-Source Diode Characteristics</b> |   |  |      |      |           |               |
| $V_{SD}$                                  | Source-Drain Diode Forward Voltage <sup>2</sup> | $V_{GS}=0V, I_S=-1A$                           | ---  | ---  | -1        | V             |

**Notes:**

1. Repetitive Rating : Pulsed width limited by maximum junction temperature.
2. The data tested by pulsed , pulse width  $\cong$  300us , duty cycle  $\cong$  2%.
3. Essentially independent of operating temperature.

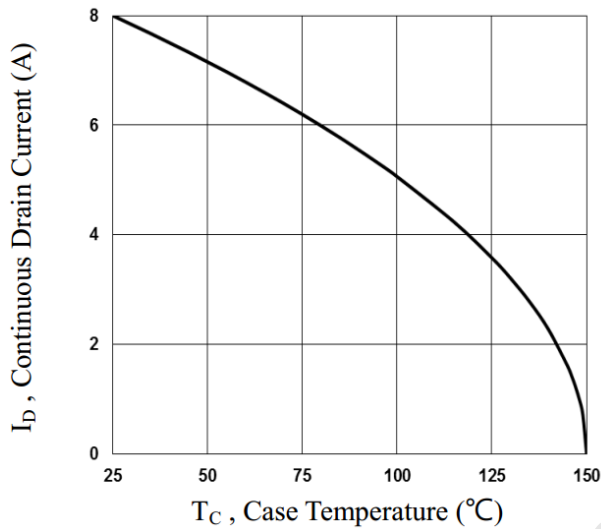
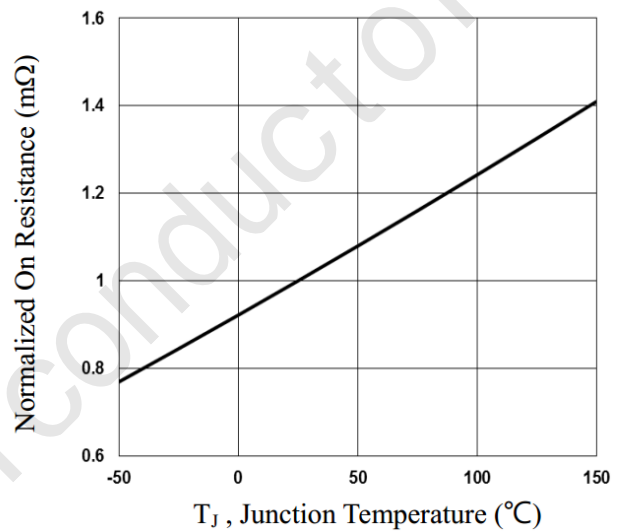
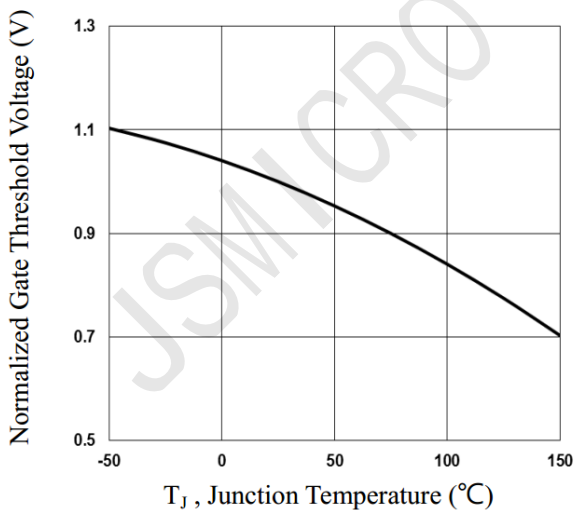
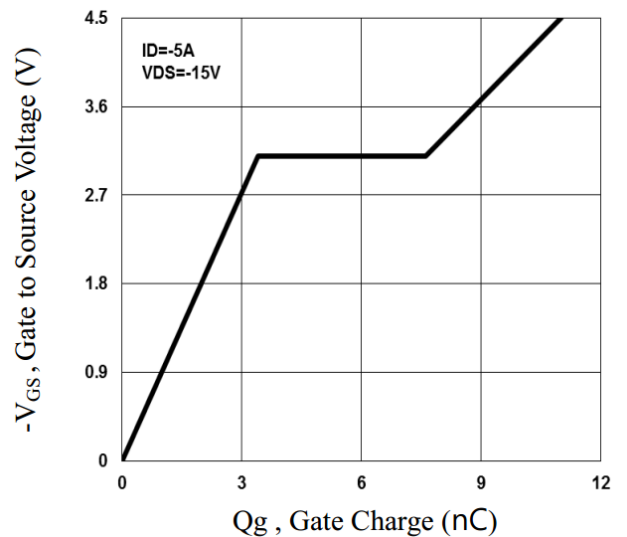
**Typical Characteristics:** ( $T_C=25^\circ\text{C}$  unless otherwise noted)

**Fig.1 Continuous Drain Current vs.  $T_C$** 

**Fig.2 Normalized  $R_{DS(on)}$  vs.  $T_J$** 

**Fig.3 Normalized  $V_{th}$  vs.  $T_J$** 

**Fig.4 Gate Charge Waveform**

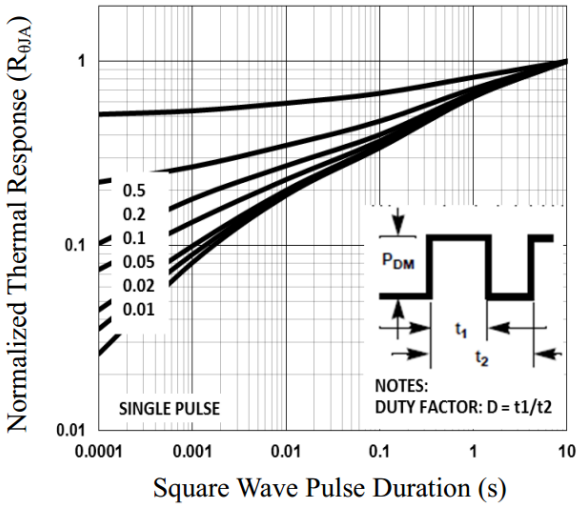

Fig.5 Normalized Transient Impedance

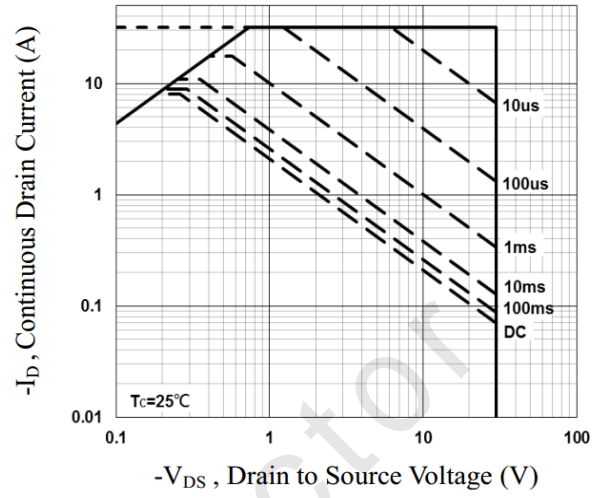

Fig.6 Maximum Safe Operation Area

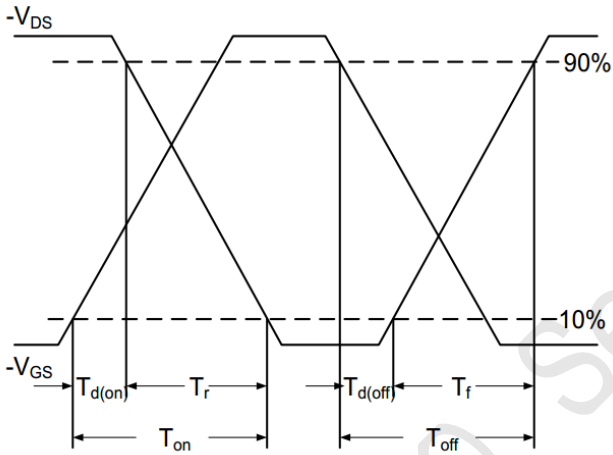

Fig.7 Switching Time Waveform

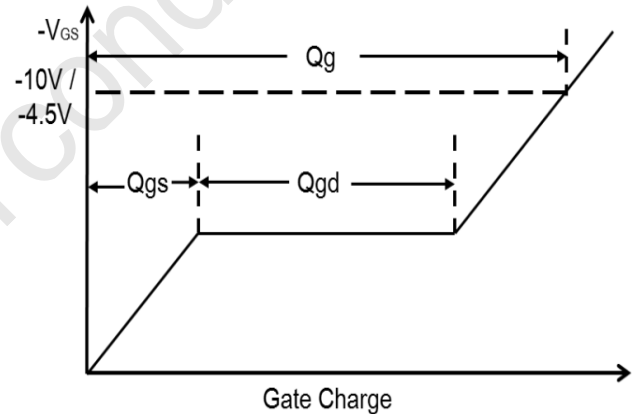
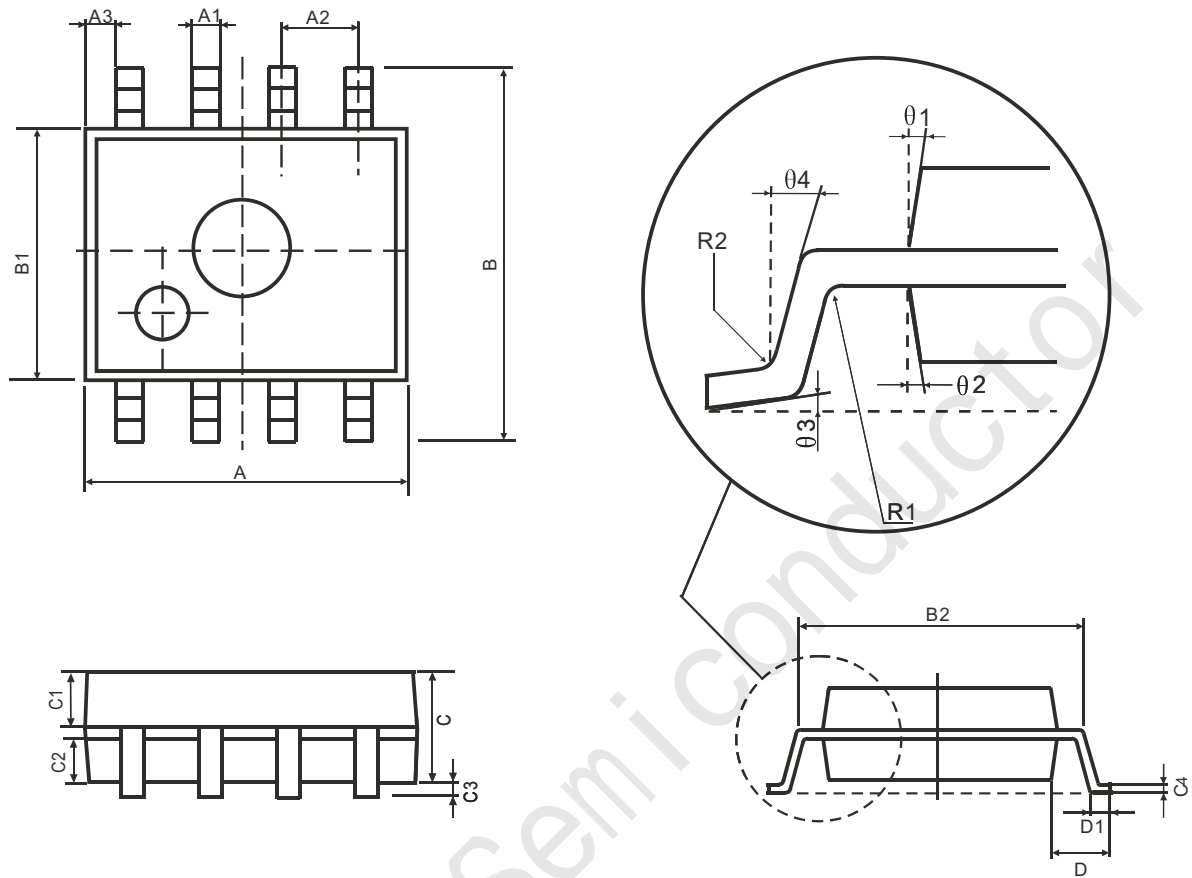

Fig.8 Gate Charge Waveform

**封装尺寸**  
**SOP8**

| 符号 | 尺寸(mm)    |      | 符号 | 尺寸(mm)    |      |
|----|-----------|------|----|-----------|------|
|    | 最小值       | 最大值  |    | 最小值       | 最大值  |
| A  | 4.95      | 5.15 | C3 | 0.05      | 0.20 |
| A1 | 0.37      | 0.47 | C4 | 0.20(典型值) |      |
| A2 | 1.27(典型值) |      | D  | 1.05(典型值) |      |
| A3 | 0.41(典型值) |      | D1 | 0.40      | 0.60 |
| B  | 5.80      | 6.20 | R1 | 0.07(典型值) |      |
| B1 | 3.80      | 4.00 | R2 | 0.07(典型值) |      |
| B2 | 5.0(典型值)  |      | θ1 | 17°(典型值)  |      |
| C  | 1.30      | 1.50 | θ2 | 13°(典型值)  |      |
| C1 | 0.55      | 0.65 | θ3 | 4°(典型值)   |      |
| C2 | 0.55      | 0.65 | θ4 | 12°(典型值)  |      |

## X-ON Electronics

Largest Supplier of Electrical and Electronic Components

*Click to view similar products for [MOSFET](#) category:*

*Click to view products by [JSMSEMI](#) manufacturer:*

Other Similar products are found below :

[614233C](#) [648584F](#) [IRFD120](#) [IRFF430](#) [JANTX2N5237](#) [2N7000](#) [FCA20N60\\_F109](#) [FDZ595PZ](#) [AOD464](#) [2SK2267\(Q\)](#) [2SK2545\(Q,T\)](#)  
[405094E](#) [423220D](#) [MIC4420CM-TR](#) [VN1206L](#) [614234A](#) [715780A](#) [SSM6J414TU,LF\(T](#) [751625C](#) [BSC884N03MS G](#) [BSF024N03LT3 G](#)  
[PSMN4R2-30MLD](#) [TK31J60W5,S1VQ\(O](#) [2SK2614\(TE16L1,Q\)](#) [DMN1017UCP3-7](#) [EFC2J004NUZTDG](#) [FCAB21350L1](#) [P85W28HP2F-](#)  
[7071](#) [DMN1053UCP4-7](#) [NTE2384](#) [NTE2969](#) [NTE6400A](#) [DMN2080UCB4-7](#) [DMN61D9UWQ-13](#) [US6M2GTR](#) [DMN31D5UDJ-7](#)  
[SSM6P54TU,LF](#) [DMP22D4UFO-7B](#) [IPS60R3K4CEAKMA1](#) [DMN1006UCA6-7](#) [DMN16M9UCA6-7](#) [STF5N65M6](#) [STU5N65M6](#)  
[C3M0021120D](#) [DMN13M9UCA6-7](#) [BSS340NWH6327XTSA1](#) [MCM3400A-TP](#) [DMTH10H4M6SPS-13](#) [IRF40SC240ARMA1](#)  
[IPS60R1K0PFD7SAKMA1](#)