

Introduction

JSM54X family consists of different Hall switches produced in BCDMOS technology. All Hall sensors include a temperature-compensated Hall plate with active offset compensation, a comparator, and an output driver. The family consists of 2-wire devices, the corresponding output driver being an open-drain output transistor and a current source respectively. The comparator compares the actual magnetic flux with the fixed reference values (switching points). Accordingly the output transistor in the current source is switched on (high current consumption) or off (low current consumption) in 2-wire version. The active offset compensation leads to constant magnetic characteristics over supply voltage and temperature range. In addition, the magnetic parameters are robust against mechanical stress effects.

The sensors are designed for industrial and automotive applications and operate with supply voltages from 2.7 V to 30V in ambient temperature range from -40 °C up to 150 °C.

The family JSM54X is available in SOT-23 and the leaded version TO92S packages.

Features

- SOT-23 and TO92S packages
- Low current consumptions of typ. 2.5 mA
- Operates from 2.7 V to 30 V supply voltage
- Overvoltage protection capability up to 40 V
- Highest ESD performance up to ± 12 kV
- Current output for 2-wire applications
- Magnetic characteristics are robust regarding mechanical stress effects
- Constant switching points over a wide supply voltage and temperature range
- Wide operating temperature range from -40 °C to 150 °C
- The decrease of magnetic flux density caused by rising temperature in the sensor system is compensated by a built-in negative temperature coefficient of the magnetic characteristics
- Reverse-voltage protection at Vcc pin
- Ideal sensor for applications in extreme automotive and industrial environments
- Qualified according to AEC-Q100 test standard for automotive electronics industry to provide the highest quality expectation

Applications

- Speed and RPM sensing
- Tachometer, counter pickup
- Flow-rate sensing
- Brushless dc motor commutation
- Motor and fan control
- Robotics control
- Proximity sensor
- Position sensor
- Seat position detection
- Seat belt buckles
- Hood/trunk/door latches
- Sun roof/convertible top/tailgate/liftgate actuation
- Brake/clutch pedals
- Electric power steering (EPS)
- Transmissions and shift selectors
- Wiper motor

Package

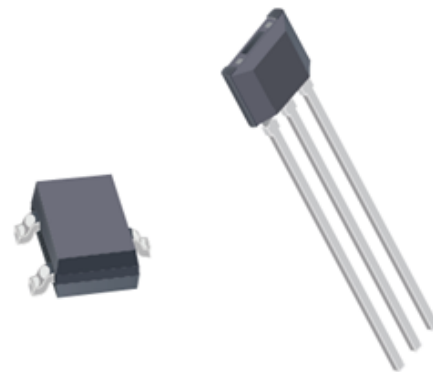

SOT23

TO92

Contents

Section	Title	Page
1.	JSM54X Family Overview	3
2.	Ordering Information	4
2.1	Marking Code	4
2.2	Operating Ambient Temperature Range	4
2.3	Hall Sensor Package Codes	4
3.	Functional Description	4
4.	Diagnostic Features	5
5.	Specifications	6
5.1	Outline Dimensions	6
5.2	Pin assignment	8
5.3	Absolute Maximum Ratings	9
5.4	ESD and Latch-up	10
5.5	Recommended Operating Conditions	10
5.6	Characteristics	10
5.7	Magnetic Characteristics Overview	11
6.	Application circuit	12
6.1	2-Wire Devices	12

1. AH54y Family Overview

The types within each family differ according to the magnetic flux density values for the magnetic switching points, the temperature behavior of the magnetic switching points, the mode of switching, the number of pins and the average current consumption. Table 1 list some devices classified in terms of switching behavior and sensitivity: higher sensitivity correlates to lower switching points.

Table 1: JSM54X 2-wire devices

Type	Sensitivity	Switching Behavior	Sensitivity
JSM541		Latching	Very high
JSM542		Latching	Medium
JSM543		Unipolar inverted	High
JSM544		Unipolar inverted	Very high
JSM545		Unipolar	Very high
JSM546		Unipolar	High

The following definitions outline the device behavior for different switching points:

Unipolar Switching Sensors:

2-wire: The sensor turns to high current consumption with the magnetic south pole on the branded side of the package and turns to low consumption if the magnetic field is removed. The sensor does not respond to the magnetic north pole on the branded side.

Current consumption

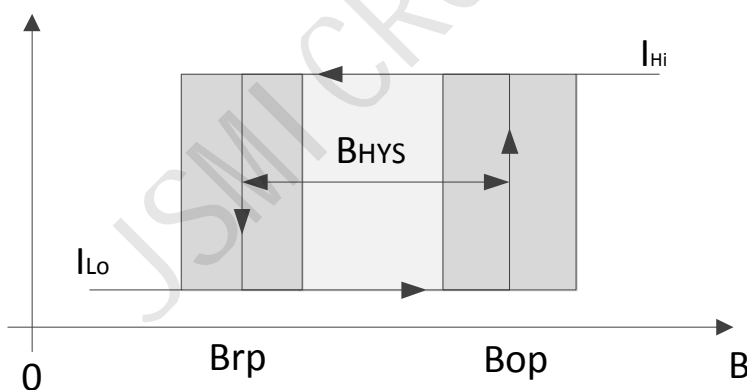

Fig. 1: Definition of magnetic switching points for 2-wire unipolar sensor.

Unipolar Switching Sensors with Inverted Output:

2-wire: The sensor turns to low current consumption with the magnetic south pole on the branded side of the package and turns to high consumption if the magnetic field is removed. The sensor does not respond to the magnetic north pole on the branded side.

Current consumption

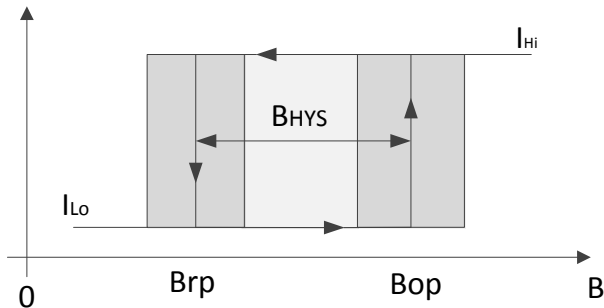

Fig. 2: Definition of magnetic switching points for 2-wire unipolar sensor with inverted output.

2. Ordering Information

2.1. Marking Code

All Hall sensors have a marking on the package surface (branded side). This marking includes the name of the sensor and date code.

2.2. Operating Ambient Temperature Range

The Hall sensors from Vinbelltech are specified to the ambient temperature.

$T_A = -40\text{ °C}$ up to 150 °C

2.3. Hall Sensor Package Codes

Hall sensors are available in a wide variety of packaging versions and quantities.

Ordering information

Part number	Package	Packing	Ambient, T_A
JSM54X	TO92S	Bulk, 1000 pieces/bag	-40 °C to 150 °C
JSM54X	SOT23	Tape&Reel, 3000 pieces/reel	-40 °C to 150 °C

3. Functional Description

JSM54X Hall effect sensor switches are available with different magnetic switching levels and output polarity.

JSM54X sensors are monolithic integrated circuits which switch in response to magnetic fields. If a magnetic field with flux lines perpendicular to the sensitive area is applied to the sensor, the biased Hall plate forces a Hall voltage proportional to this field.

The Hall voltage is compared with the actual threshold level in the comparator. If the magnetic field exceeds the threshold levels, the output stage (current source for 2-wire devices) is switched to the appropriate state. The built-in hysteresis eliminates oscillation and provides switching behavior of output without bouncing.

Magnetic offset caused by mechanical stress is compensated by using the chopping offset compensation technique. A serial resistor or diode on the supply line is not required thanks to the built-in reverse voltage protection.

The open drain output is forced to a safe, high-impedance state (tri-state), in any of the following fault conditions: overtemperature, and undervoltage. In addition, the output current is limited (short-circuit protection).

The device is able to withstand a maximum supply voltage of 28 V for unlimited time and features overvoltage capability (40V load dump).

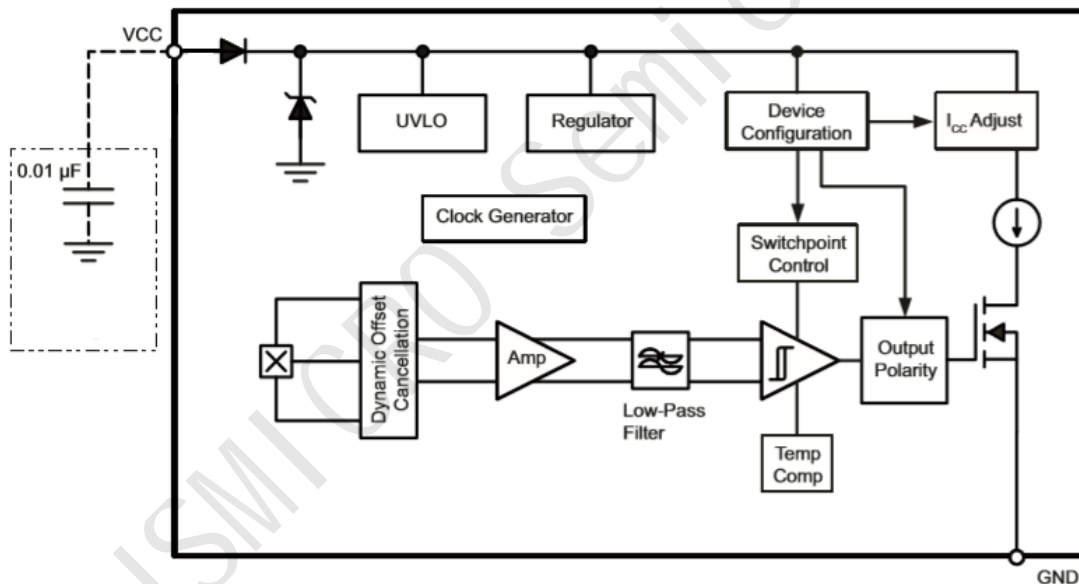

Fig.3:JSM54X- 2-wire - Block diagram

4. Diagnostic Features

Internal states are monitored and in an error condition flagged with a tri-state at the output a low current level (2-wires devices):

- Internal voltage regulator: under and over voltage detection
- Monitoring of internal bias and current levels
- Monitoring of the internal reference voltage
- Monitoring of the Hall plate voltage

5. Specifications

5.1. Outline Dimensions

T092S

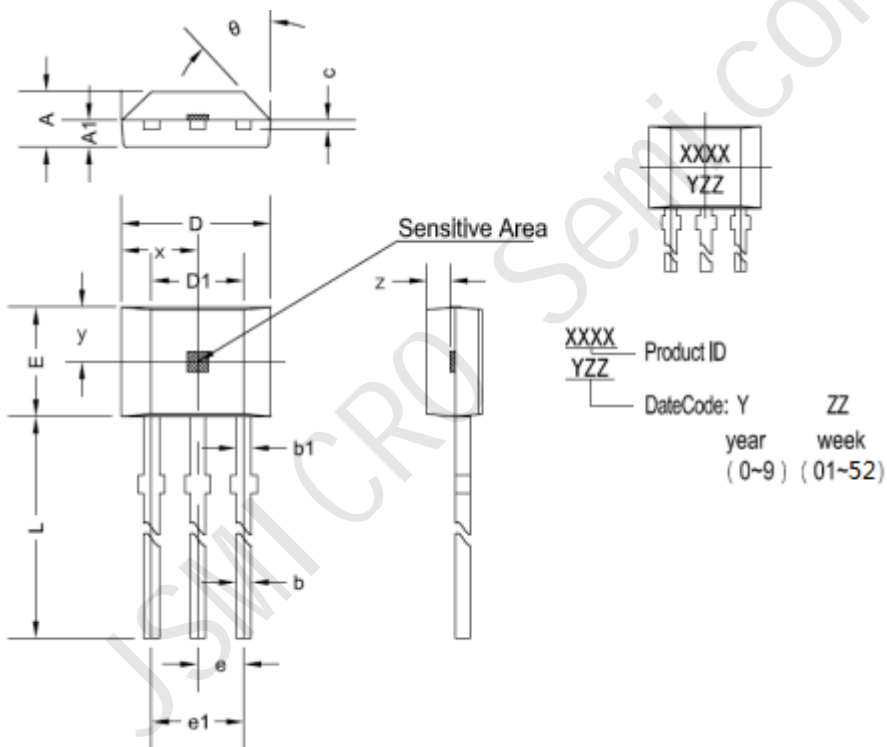

T092S dimensions

Symbol	Size (mm)		Size (in inches)	
	minimum	maximum	minimum	maximum
A	1.42	1.67	0.056	0.066
A1	0.66	0.86	0.026	0.034
b	0.35	0.56	0.014	0.022
b1	0.4	0.55	0.016	0.022
C	0.36	0.51	0.014	0.02
D	3.9	4.2	0.154	0.165
D1	2.97	3.27	0.117	0.129
E	2.9	3.28	0.114	0.129
e	1.270 TYP		0.050 TYP	
e1	2.44	2.64	0.096	0.104
L	13.5	15.5	0.531	0.61
x	2.025TYP		0.080TYP	
y	1.545TYP		0.061TYP	
z	0.500TYP		0.020TYP	
θ	45°TYP		45°TYP	

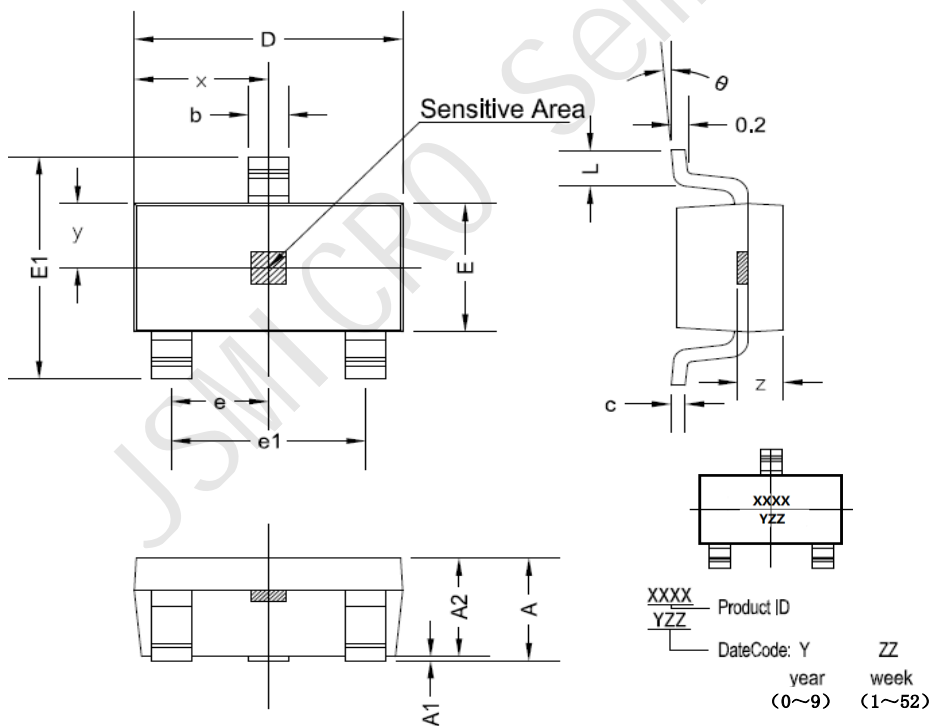

SOT23 dimensions

Symbol	Size (mm)		Size (in inches)	
	minimum	maximum	minimum	maximum
A	1.05	1.25	0.041	0.049
A1	0	0.1	0	0.004
A2	1.05	1.15	0.041	0.045
b	0.3	0.5	0.012	0.02
c	0.100	0.2	0.004	0.008
D	2.82	3.02	0.111	0.119
E	1.5	1.7	0.059	0.067
E1	2.65	2.95	0.104	0.116
e	0.950 TYP		0.037 TYP	
e1	1.8	2	0.071	0.079
L	0.3	0.6	0.012	0.024
x	1.460TYP		0.057TYP	
y	0.800TYP		0.032TYP	
z	0.600TYP		0.024TYP	
θ	0°		8°	

5.2. Pin assignment

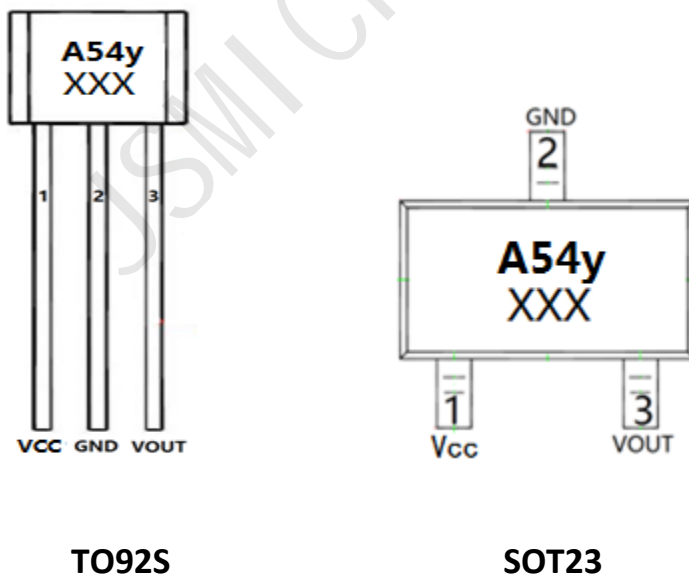

Fig.4: Pin assignment of TO92S and SOT23

Pin assignment

Pin number	Name	Function
1	VCC	Power supply
2	GND	Ground
3	Vout	Output

5.3. Absolute Maximum Ratings

Stresses beyond those listed in the “Absolute Maximum Ratings” may cause permanent damage to the device. This is a stress rating only. Functional operation of the device at these conditions is not implied. Exposure to absolute maximum rating conditions for extended periods will affect device reliability.

This device contains circuitry to protect the inputs and outputs against damage due to high static voltages or electric fields; however, it is advised that normal precautions be taken to avoid application of any voltage higher than absolute maximum-rated voltages to this circuit.

All voltages listed are referenced to ground (GND).

Symbol	Parameter	Pin No	Min.	Max.	Unit	Conditions
V _{CC}	Supply voltage	1	-20	32	V	t < 1000 h ¹⁾
				34	V	t < 96 h ¹⁾
				36	V	t < 5 min ¹⁾
				40	V	t < 5 x 400 ms ¹⁾ with series resistor R _V > 100 Ω
V _{OUT}	Output voltage	3	-0.5	32	V	t < 1000 h ¹⁾
				34	V	t < 96 h ¹⁾
				36	V	t < 5 min ¹⁾
				40	V	t < 5 x 400 ms ¹⁾ with series resistor R _L > 100 Ω
I _O	Output current	3		65	mA	
I _{OR}	Reverse output current	3	-50		mA	
T _A	Ambient temperature range		-40	170	°C	t < 96 h ¹⁾

¹⁾ No cumulative stress

5.4. ESD and Latch-up

The output pin has to be in tri-state (high impedance) for ESD measurements.

ESD and latch-up

Symbol	Parameter	Min	Max	Unit
I_{latch}	Maximum latch-up free current at any pin (measurement according to AEC Q100-004), class 1	-100	100	mA
V_{HBM}	Human body model (according to AEC Q100-002)	-12	12	kV

5.5. Recommended Operating Conditions

Functional operation of the device beyond those indicated in the “Recommended Operating Conditions” of this specification is not implied, may result in unpredictable behavior of the device and may reduce reliability and lifetime.

All voltages listed are referenced to ground (GND).

Symbol	Parameter	Pin No	Min	Typ	Max	Unit	Conditions
V_{CC}	Supply voltage	1	3.0		30	V	2-wire
T_A	Ambient temperature range		-40		150	°C	
V_{OUT}	Output voltage	3			30	V	
I_{OUT}	Output current	3			25	mA	

5.6. Characteristics

at $T_A = -40\text{ °C}$ to 150 °C , $V_{CC} = 3.0\text{ V}$ to 24 V , at Recommended Operation Conditions if not otherwise specified in the column “Conditions”. Typical Characteristics for $T_A = 25\text{ °C}$ and $V_{CC} = 12\text{ V}$

Symbol	Parameter	Pin No	Min	Typ	Max	Unit	Conditions
Supply							
I_{cclo}	Low supply current	1	2		5	mA	2-wire JSM544, JSM545

I_{cclo}	Low supply current	1	5		7	mA	2-wire JSM541 JSM542 JSM543 JSM546
I_{ccHi}	High supply current	1	12		17	mA	2-wire
I_{ccR}	Reverse current				1	mA	for $V_{cc} = -18\text{ V}$
Port Output							
V_{ol}	Port low output voltage	3		0.13	0.4	V	$I_O = 20\text{ mA}$
					0.5	V	$I_O = 25\text{ mA}$
t_f	Output fall time				1	μs	$V_{cc} = 12\text{V}; R_L = 820\ \Omega; C_L = 20\text{ pF}$
t_r	Output rise time				1	μs	
B_{noise}	Effective noise of magnetic switching points			0.1		mT	For square wave signal with 1 kHz
t_j	Output jitter				± 0.5	μs	For square wave signal with 1 kHz
t_d	Delay time			16		μs	
t_{smp}	Output refresh period		1.6	2	2.66	μs	
t_{en}	Enable time of output after settling of V_{cc}			50		μs	$V_{cc} = 12\text{V}$ $B > B_{on} + 2\text{ mT}$ or $B < B_{off} - 2\text{ mT}$

5.7. Magnetic Characteristics Overview

$T_A = -40\text{ }^\circ\text{C}$ to $150\text{ }^\circ\text{C}$, $V_{cc} = 3.0\text{ V}$ to 30 V , $GND = 0\text{ V}$, recommended operation conditions if not otherwise specified in the column "Conditions". Typical characteristics for $T_A = 25\text{ }^\circ\text{C}$.

Sensor	Switching Type	Temp. coeff. of magnetic thresh. TC [ppm/K]	On point BON [mT]			Off point BOFF [mT]			Hysteresis BHYS [mT]		
			Min	Typ	Max	Min	Typ	Max	Min	Typ	Max
2-wire											

JSM541	latching	0	4.0	-4.0	-	8.0	-
JSM542	latching	0	12.0	-12.0	-	24.0	-
JSM543	unipolar inverted	0	7.0	9.0	-	2.0	-
JSM544	unipolar inverted	0	4.0	6.0	-	2.0	-
JSM545	unipolar	0	6.0	4.0	-	2.0	-
JSM546	unipolar	0	9.0	7.0	-	2.0	-

The hysteresis is the difference between the switching points $B_{HYS} = B_{ON} - B_{OFF}$

6. Application circuit

6.1. 2-Wire Devices

Fig.5 shows a simple application with a 2-wire sensor. The current consumption can be detected by measuring the voltage over R_L . For correct functioning of the sensor, the voltage between V_{CC} and GND must be a minimum of V_{CCmin} .

With the maximum current consumption of $I_{cchimax}$, the maximum R_L can be calculated as: $R_{Lmax} = \frac{V_{BATTmin} - V_{CCmin}}{I_{cchimax}}$

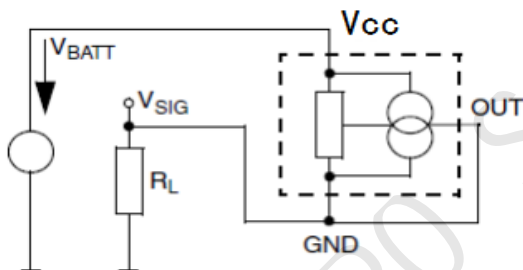

Fig. 6 : Example 2-wire application circuit 1

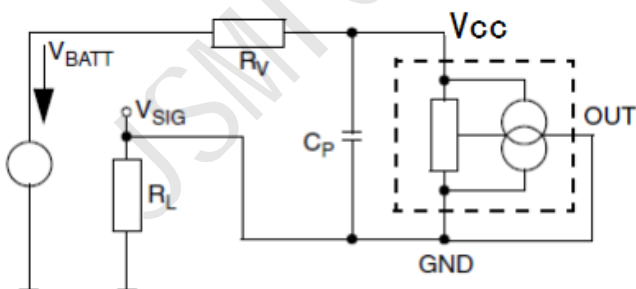

Fig. 7: Example 2-wire application circuit 2

For applications with disturbances on the supply line or radiated disturbances, a series resistor R_V and a capacitor C_P both placed close to the sensor are recommended (see Fig. 6). In this case, the maximum R_L can be calculated as:

$$R_{Lmax} = \frac{V_{BATTmin} - V_{CCmin}}{I_{cchimax}} - R_V$$

X-ON Electronics

Largest Supplier of Electrical and Electronic Components

Click to view similar products for [Board Mount Hall Effect/Magnetic Sensors](#) category:

Click to view products by [JSMSEMI](#) manufacturer:

Other Similar products are found below :

[HGPRDT005A](#) [AH277AZ4-AG1](#) [AV-10379](#) [AV-10448](#) [SS41C](#) [AH1894-Z-7](#) [TLE4917](#) [50017859-003](#) [TY-13101](#) [TLE4976L](#) [SS85CA](#)
[BU52002GUL-E2](#) [BU52003GUL-E2](#) [AH277AZ4-BG1](#) [TLE49614MXTSA1](#) [AH211Z4-AG1](#) [AH3360-FT4-7](#) [TLE4941-1](#) [SS460S-](#)
[100SAMPLE](#) [50065820-03](#) [AH374-P-A](#) [AH3372-P-B](#) [AH1806-P-A](#) [TLE49595UFXHALA1](#) [SS460P-T2](#) [AH1913-W-7](#) [AH3373-P-B](#)
[TLV4961-1M](#) [TLE9852QXXUMA1](#) [TLE5046ICAKLRHALA1](#) [AH1903-FA-EVM](#) [AH8502-FDC-EVM](#) [TLE4998S3XALA1](#)
[TLE5011FUMA1](#) [TLE5027CE6747HAMA1](#) [TLE5109A16E1210XUMA1](#) [TLI4966GHTSA1](#) [TLI4906KHTSA1](#) [MA710GQ-P](#) [S-](#)
[57K1NBL2A-M3T2U](#) [S-57P1NBL9S-M3T4U](#) [S-576ZNL2B-L3T2U](#) [S-576ZNL2B-A6T8U](#) [S-57P1NBL0S-M3T4U](#) [S-57A1NSL1A-M3T2U](#)
[S-57K1RBL1A-M3T2U](#) [S-57P1NBH9S-M3T4U](#) [S-57P1NBH0S-M3T4U](#) [S-57A1NSH1A-M3T2U](#) [S-57A1NSH2A-M3T2U](#)