

**Description**

The JSM7409B uses advanced trench technology to provide excellent  $R_{DS(ON)}$ , low gate charge and operation with gate voltages as low as 4.5V.

**General Features**

- $V_{DS} = -30V, I_D = -25A$   
 $R_{DS(ON)} < 30m\Omega @ V_{GS} = -4.5V$   
 $R_{DS(ON)} < 17m\Omega @ V_{GS} = -10V$
- High power and current handing capability
- Lead free product is acquired
- Surface mount package

**Application**

- Battery Switch
- Load switch
- Power management

**PDFN3X3-8L**

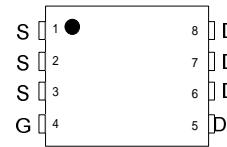

**Equivalent Circuit**

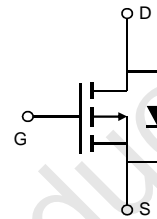

**MARKING**

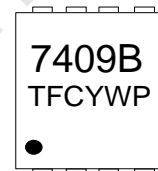

Y : year code W : week code

**Absolute Maximum Ratings ( $T_A = 25^\circ C$  unless otherwise noted)**

Parameter		Symbol	Limit	Unit
Drain-Source Voltage		$V_{DS}$	-30	V
Gate-Source Voltage		$V_{GS}$	$\pm 20$	V
Continuous Drain Current ( $T_J = 150^\circ C$ )	$T_A = 25^\circ C$	$I_D$	-10	A
	$T_A = 70^\circ C$		-8.0	
Drain Current-Pulsed <sup>(Note 1)</sup>		$I_{DM}$	-45	A
Maximum Power Dissipation		$P_D$	3.1	W
Operating Junction and Storage Temperature Range		$T_J, T_{STG}$	-55 To 150	$^\circ C$

**Thermal Characteristic**

Thermal Resistance, Junction-to-Ambient <sup>(Note 2)</sup>	$R_{\theta JA}$	40	$^\circ C/W$
---	-----------------	----	--------------

**Electrical Characteristics (T<sub>A</sub>=25°C unless otherwise noted)**

Parameter	Symbol	Condition	Min	Typ	Max	Unit
<b>Off Characteristics</b>						
Drain-Source Breakdown Voltage	BV <sub>DSS</sub>	V <sub>GS</sub> =0V, I <sub>D</sub> =-250μA	-30	-33	-	V
Zero Gate Voltage Drain Current	I <sub>DSS</sub>	V <sub>DS</sub> =-30V, V <sub>GS</sub> =0V	-	-	-1	μA
Gate-Body Leakage Current	I <sub>GSS</sub>	V <sub>GS</sub> =±20V, V <sub>DS</sub> =0V	-	-	±100	nA
<b>On Characteristics</b> (Note 3)						
Gate Threshold Voltage	V <sub>GS(th)</sub>	V <sub>DS</sub> =V <sub>GS</sub> , I <sub>D</sub> =-250μA	1.0	1.7	3.0	V
Drain-Source On-State Resistance	R <sub>DS(ON)</sub>	V <sub>GS</sub> =-10V, I <sub>D</sub> =-10A	-	14	17	mΩ
		V <sub>GS</sub> =-4.5V, I <sub>D</sub> =-10A	-	25	30	mΩ
Forward Transconductance	g <sub>FS</sub>	V <sub>DS</sub> =-15V, I <sub>D</sub> =-10A	10	-	-	S
<b>Dynamic Characteristics</b> (Note 4)						
Input Capacitance	C <sub>iss</sub>	V <sub>DS</sub> =-15V, V <sub>GS</sub> =0V, F=1.0MHz	-	1600	-	PF
Output Capacitance	C <sub>oss</sub>		-	350	-	PF
Reverse Transfer Capacitance	C <sub>rss</sub>		-	300	-	PF
<b>Switching Characteristics</b> (Note 4)						
Turn-on Delay Time	t <sub>d(on)</sub>	V <sub>DD</sub> =-15V, I <sub>D</sub> =-1A, V <sub>GS</sub> =-10V, R <sub>GEN</sub> =6Ω	-	10	-	nS
Turn-on Rise Time	t <sub>r</sub>		-	15	-	nS
Turn-Off Delay Time	t <sub>d(off)</sub>		-	110	-	nS
Turn-Off Fall Time	t <sub>f</sub>			70	-	nS
Total Gate Charge	Q <sub>g</sub>	V <sub>DS</sub> =-15V, I <sub>D</sub> =-10A V <sub>GS</sub> =-10V	-	30	-	nC
Gate-Source Charge	Q <sub>gs</sub>		-	5.5	-	nC
Gate-Drain Charge	Q <sub>gd</sub>		-	8	-	nC
<b>Drain-Source Diode Characteristics</b>						
Diode Forward Voltage (Note 3)	V <sub>SD</sub>	V <sub>GS</sub> =0V, I <sub>S</sub> =-10A	-	-	1.2	V

**Notes:**

1. Repetitive Rating: Pulse width limited by maximum junction temperature.
2. Surface Mounted on FR4 Board, t ≤ 10 sec.
3. Pulse Test: Pulse Width ≤ 300μs, Duty Cycle ≤ 2%.
4. Guaranteed by design, not subject to production

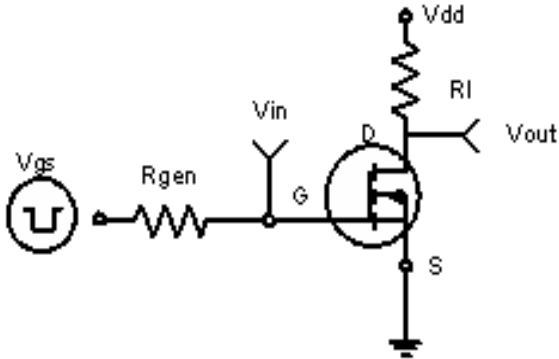
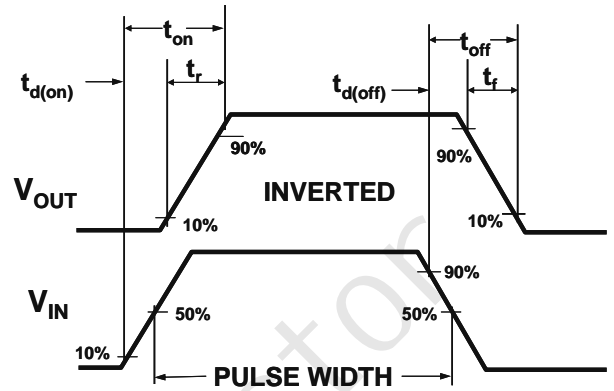
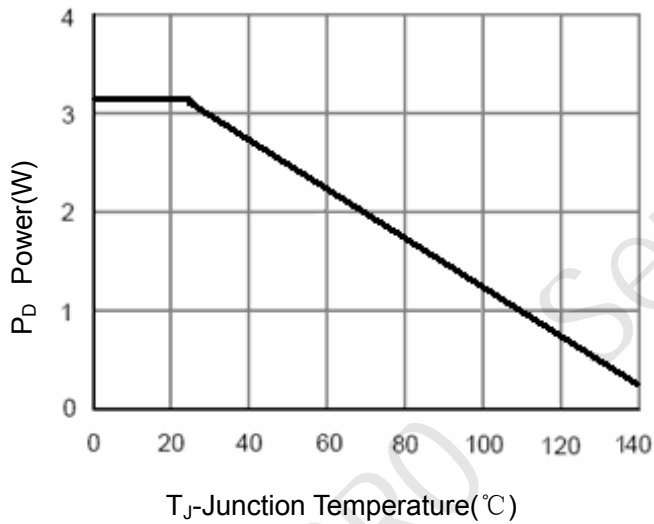
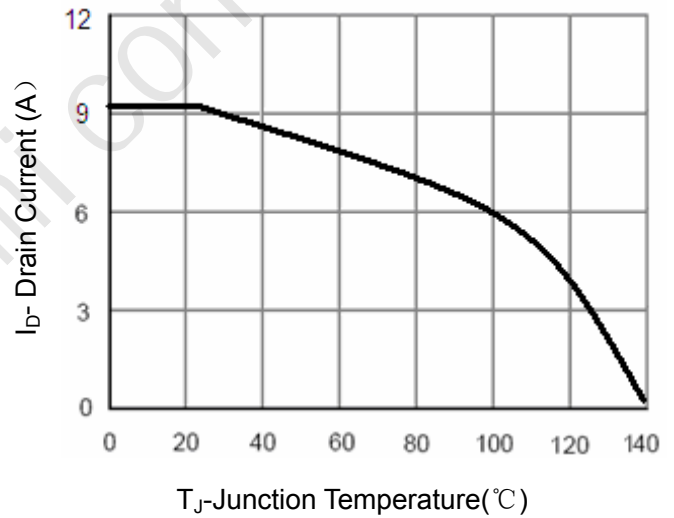
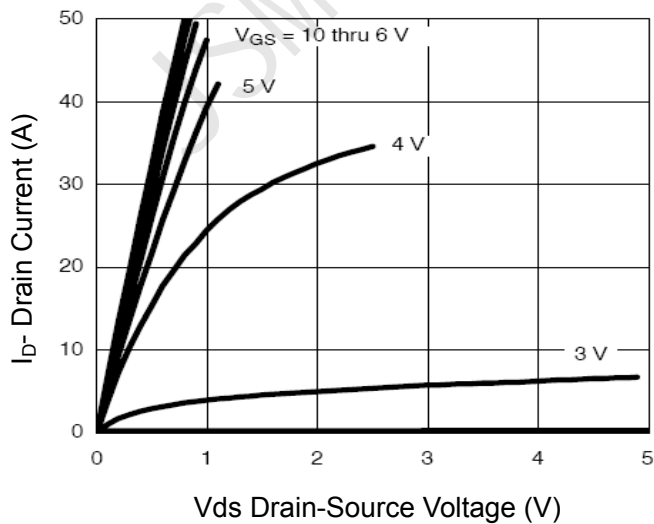
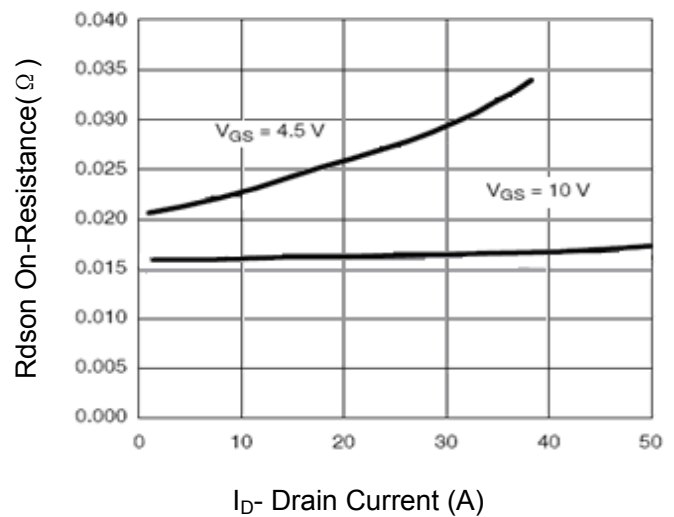
**Typical Electrical and Thermal Characteristics**

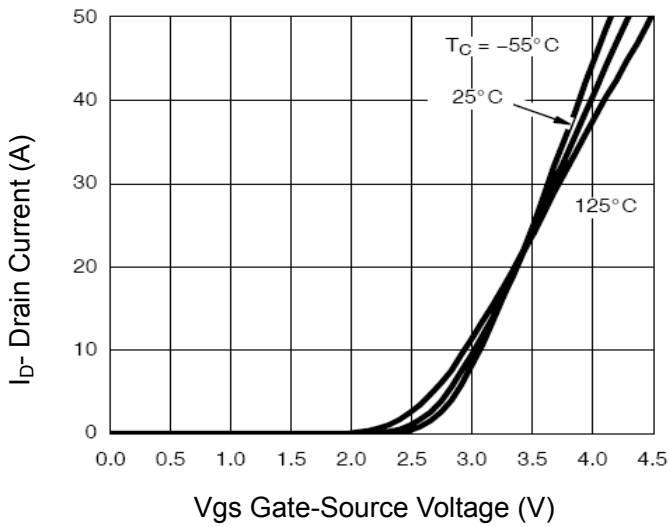
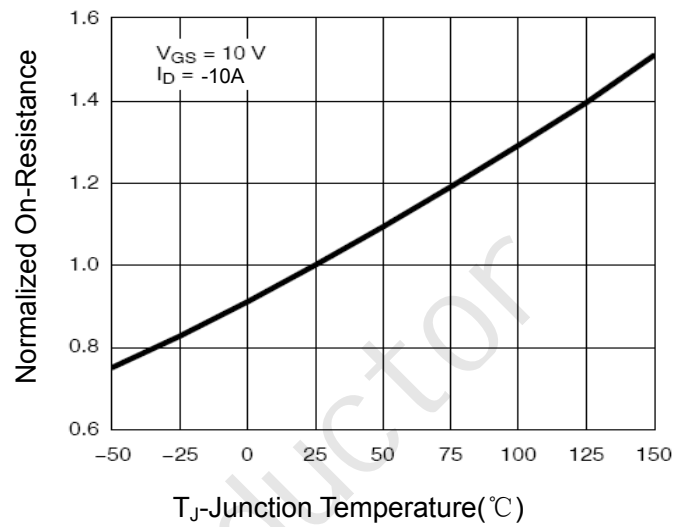
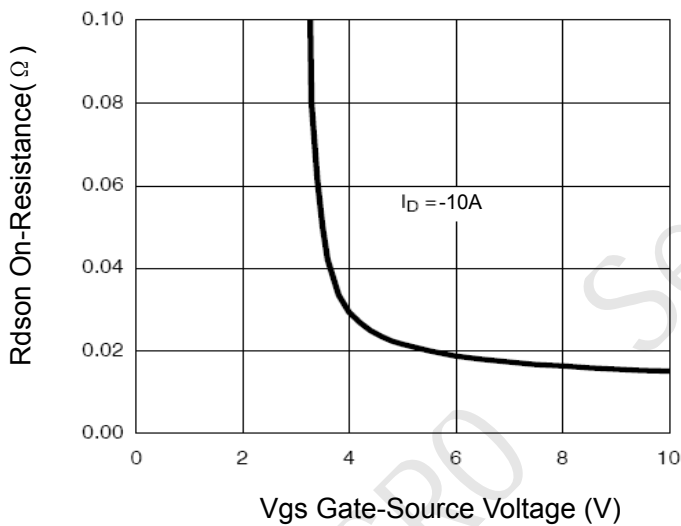
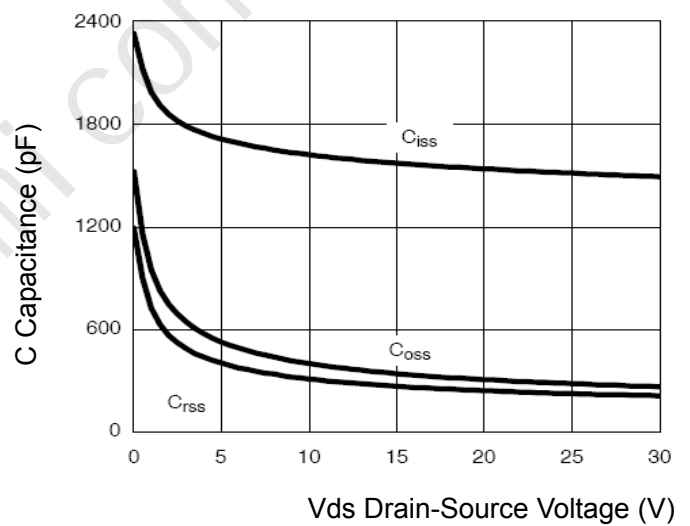
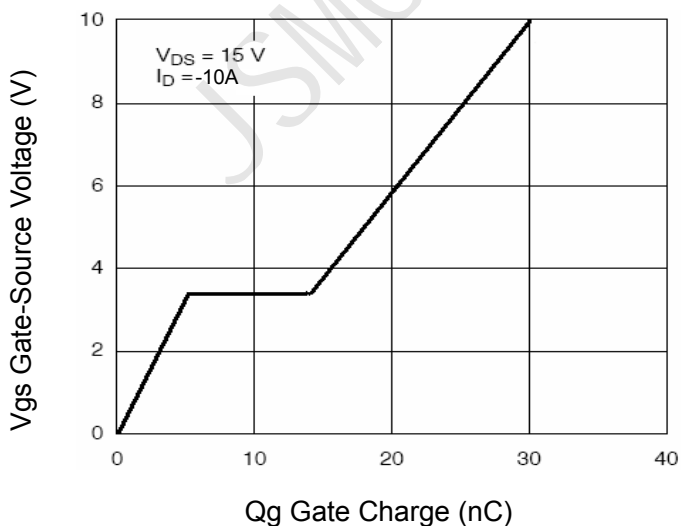
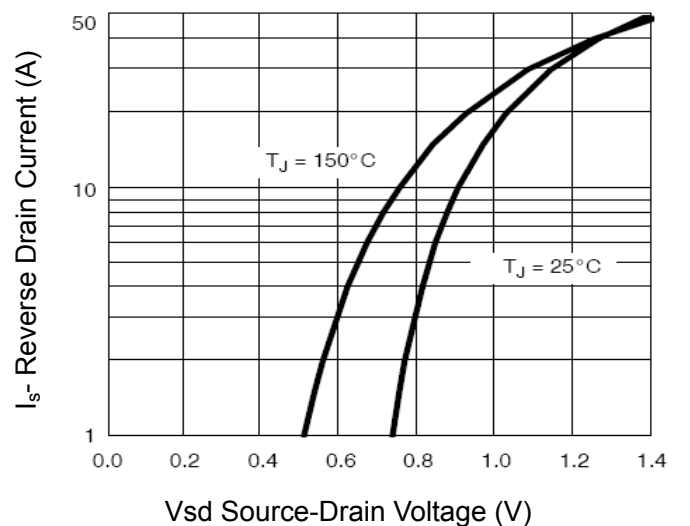
**Figure 1: Switching Test Circuit**

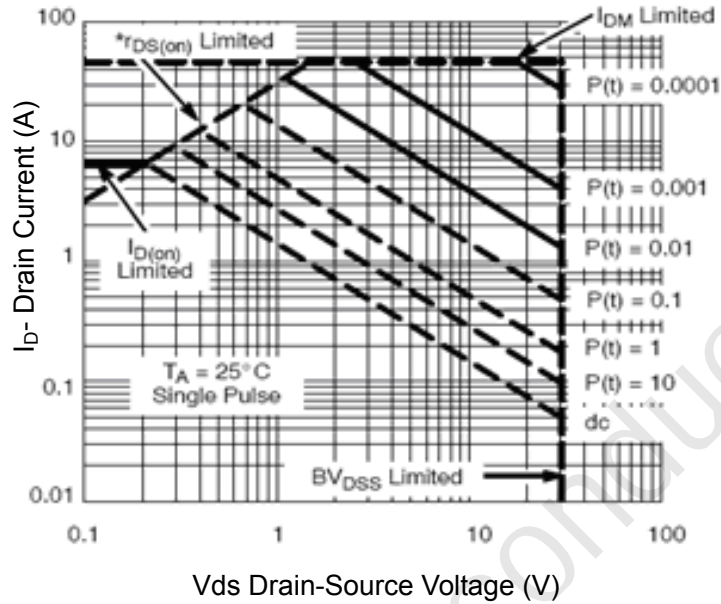
**Figure 2: Switching Waveforms**

**Figure 3 Power Dissipation**

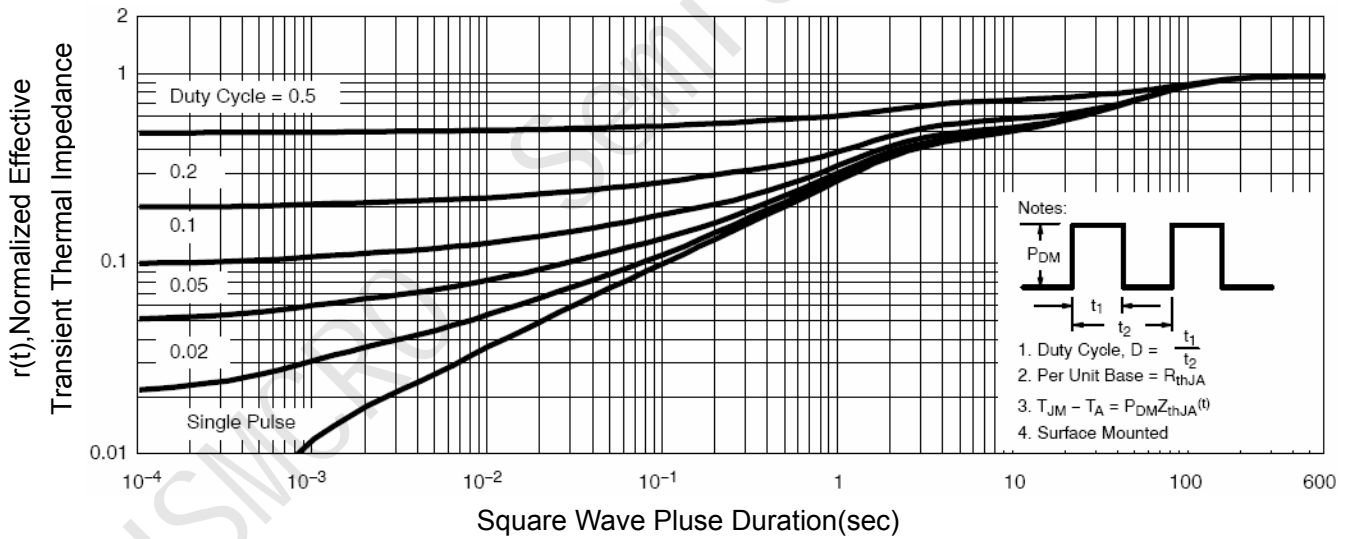
**Figure 4 Drain Current**

**Figure 5 Output Characteristics**

**Figure 6 Drain-Source On-Resistance**

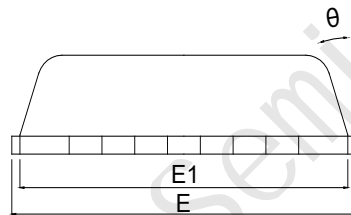
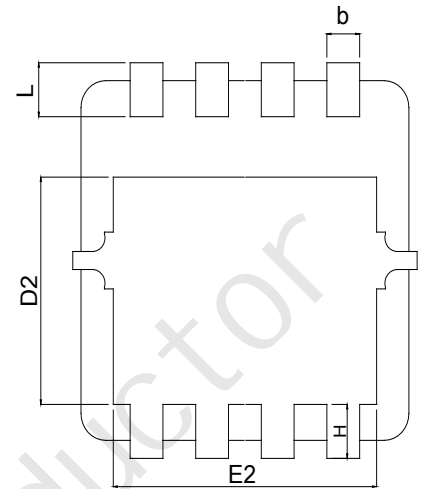
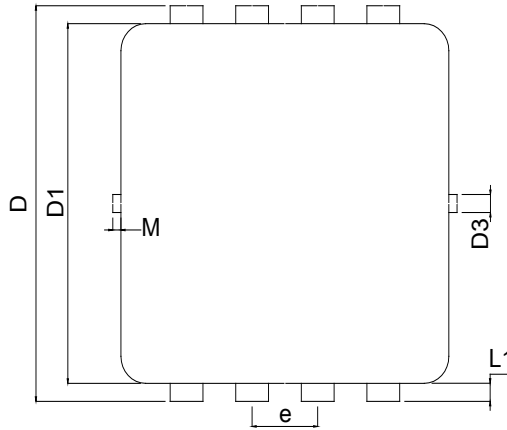
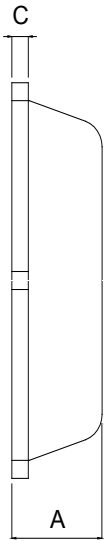
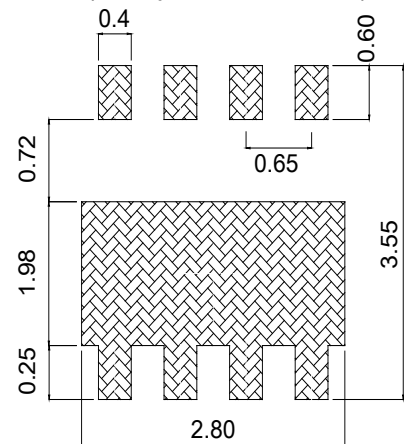

**Figure 7 Transfer Characteristics**

**Figure 8 Drain-Source On-Resistance**

**Figure 9 Rdson vs Vgs**

**Figure 10 Capacitance vs Vds**

**Figure 11 Gate Charge**

**Figure 12 Source- Drain Diode Forward**



**Figure 13 Safe Operation Area**



**Figure 14 Normalized Maximum Transient Thermal Impedance**

**Package Information**
**PDFN3333**

**Land Pattern**  
 ( Only for Reference )

SYMBOL	MM			INCH			SYMBOL	MM			INCH		
	MIN	NOM	MAX	MIN	NOM	MAX		MIN	NOM	MAX	MIN	NOM	MAX
A	0.70	0.75	0.80	0.028	0.030	0.031	E1	3.00	3.15	3.20	0.118	0.122	0.126
b	0.25	0.30	0.35	0.010	0.012	0.014	E2	2.39	2.49	2.59	0.094	0.098	0.102
c	0.10	0.15	0.25	0.004	0.007	0.010	e	0.65BSC			0.026BSC		
D	3.25	3.35	3.45	0.128	0.132	0.136	H	0.30	0.40	0.50	0.012	0.016	0.020
D1	3.00	3.10	3.20	0.118	0.122	0.126	L	0.30	0.40	0.50	0.012	0.016	0.020
D2	1.78	1.88	1.98	0.070	0.074	0.078	L1	*	0.13	*	*	0.005	*
D3	*	0.13	*	*	0.005	*	θ	*	10°	12°	*	10°	12°
E	3.20	3.30	3.40	0.126	0.130	0.134	M	*	*	0.15	*	*	0.006

## X-ON Electronics

Largest Supplier of Electrical and Electronic Components

*Click to view similar products for [MOSFET](#) category:*

*Click to view products by [JSMSEMI](#) manufacturer:*

Other Similar products are found below :

[614233C](#) [648584F](#) [NTNS3A92PZT5G](#) [IRFD120](#) [IRFF430](#) [JANTX2N5237](#) [2N7000](#) [2SK2464-TL-E](#) [FCA20N60\\_F109](#) [FDZ595PZ](#) [AOD464](#)  
[2SK2267\(Q\)](#) [2SK2545\(Q,T\)](#) [405094E](#) [423220D](#) [MIC4420CM-TR](#) [VN1206L](#) [614234A](#) [715780A](#) [SSM6J414TU,LF\(T](#) [751625C](#)  
[IPP60R600P6XKSA1](#) [RJK60S5DPK-M0#T0](#) [BSC884N03MS G](#) [BSF024N03LT3 G](#) [PSMN4R2-30MLD](#) [TK31J60W5,S1VQ\(O](#)  
[2SK2614\(TE16L1,Q\)](#) [DMN1017UCP3-7](#) [EFC2J004NUZTDG](#) [FCAB21350L1](#) [P85W28HP2F-7071](#) [DMN1053UCP4-7](#) [NTE2384](#) [NTE2969](#)  
[NTE6400A](#) [DMN2080UCB4-7](#) [DMN61D9UWQ-13](#) [US6M2GTR](#) [DMN31D5UDJ-7](#) [SSM6P54TU,LF](#) [DMP22D4UFO-7B](#)  
[IPS60R3K4CEAKMA1](#) [DMN1006UCA6-7](#) [DMN16M9UCA6-7](#) [STF5N65M6](#) [STU5N65M6](#) [C3M0021120D](#) [DMN13M9UCA6-7](#)  
[BSS340NWH6327XTSA1](#)