

Description

The LM2575SX/T-LM2576SX/T series switching regulators are monolithic integrated circuits designed for use in "buck" or "buck/boost" regulator applications requiring accurate output voltages over combined variations of line, load and temperature. This unique series greatly simplifies switching power supply design. The LM2575 has a maximum output current of 1A and the LM2576 is rated for 3A.

The LM2575SX/T-LM2576SX/T series miniconverters include a switching regulator and compensation network all within the same package. Just add a choke, catch diode and two capacitors to obtain an efficient DC-to-DC converter. The current limit and thermal shutdown features of the LM2575SX/T-LM2576SX/T series fully protect the device against overstress conditions.

The LM2575SX/T-LM2576SX/T series offers an alternative to popular 3-terminal linear regulators by providing higher efficiency with reduced heatsink size. In many applications a heatsink will not be required.

Features

- ◆ Pin for pin replacement for National's LM2575S/6S series
- ◆ DC-to-DC buck or buck/boost converter requiring only 4 support components
- ◆ Fixed or adjustable voltages
- ◆ Preset output voltages of 3.3V, 5V and 12V
- ◆ Wide output voltage range, 1.23V to 35V
- ◆ 82% typical efficiency @ 5V out
- ◆ Wide input voltage range, 4V to 40V
- ◆ Inhibit/enable control pin
- ◆ Industrial temperature range
- ◆ TO-220 and TO-263 packages

Applications

- ◆ Micro controller power supplies
- ◆ Medical equipment
- ◆ Industrial power supplies
- ◆ Instrumentation power supplies

	LM2575SX/T	LM2576SX/T
L_1	330 μ H	100 μ H
D_1	3A	7A
C_{IN}	68 μ F	120 μ F
C_{OUT}	330 μ F	1,000 μ F

Typical Application Circuits

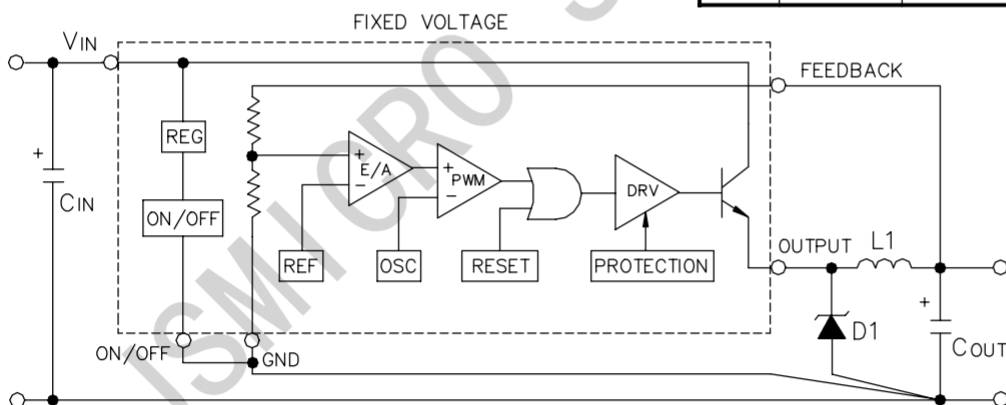

$$V_o + 2 \leq V_{in} \leq \text{RATED}$$

ADJUSTABLE VOLTAGE

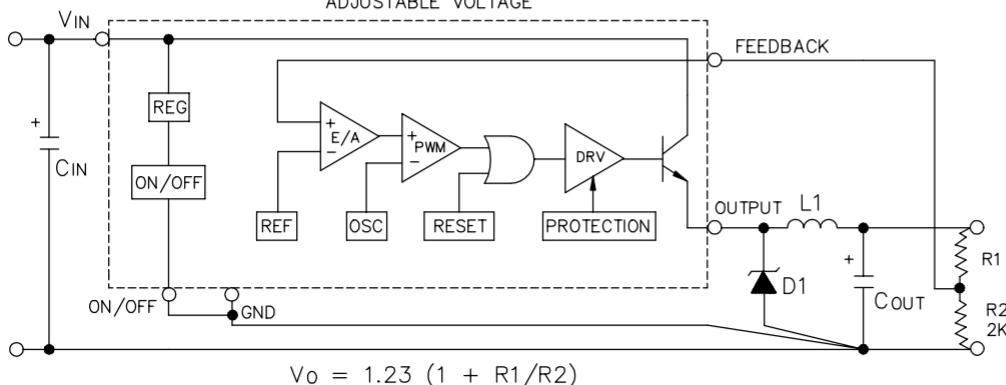

Absolute Maximum Ratings

Parameter	Symbol	Maximum	Units
Input Voltage	V_{IN}	45	V
On/Off Pin Input Voltage	$V_{ON/OFF}$	$-0.3 \leq V_{ON/OFF} \leq V_{IN}$	V
Output Voltage to Common (Steady State)		-1	V
Power Dissipation	P_D	Internally Limited	W
Thermal Resistance Junction to Ambient TO-220 TO-263	θ_{JA}	55 60	$^{\circ}\text{C}/\text{W}$
Thermal Resistance Junction to Case TO-220 TO-263	θ_{JC}	2.0 2.0	$^{\circ}\text{C}/\text{W}$
Operating Junction Temperature Range	T_J	-40 to +125	$^{\circ}\text{C}$
Storage Temperature Range	T_{STG}	-65 to +150	$^{\circ}\text{C}$
Lead Temperature (Soldering) 10 Sec.	T_{LEAD}	300	$^{\circ}\text{C}$
ESD Rating (Human Body Model)	V_{ESD}	2	kV

Electrical Characteristics

Unless otherwise specified: $V_{IN} = 12\text{V}$ for 3.3V, 5V and ADJ options and 25V for 12V option; $V_{OUT} = 5\text{V}$ for ADJ option; $T_A = 25^{\circ}\text{C}$; V_{IN} rated = 40V; $I_O = 0.5$ to 3A (LM2576), 0.2 to 1A (LM2575). Values in **bold** apply over full operating temperature range.

Parameter	Symbol	Test Conditions	Min	Typ	Max	Units
Output Voltage	V_O	$I_O = 0.5\text{A}$	3.23	3.30	3.37	V
LM2576SX/T-3.3		8V to V_{IN} Rated		3.20	3.40	
			3.14		3.47	
Output Voltage	V_O	$I_O = 0.5\text{A}$	4.90	5.00	5.10	V
LM2576SX/T-5.0		8V to V_{IN} Rated	4.85		5.15	
			4.75		5.25	
Output Voltage	V_O	$I_O = 0.5\text{A}$	11.76	12.00	12.24	V
LM2576SX/T-12		15V to V_{IN} Rated	11.52		12.48	
			11.40		12.60	
Feedback Voltage	V_{FB}	$I_O = 0.5\text{A}$	1.217	1.230	1.243	V
LM2576SX/T-ADJ		$V_O = 5\text{V}$	1.193		1.267	
		8V to V_{IN} Rate	1.180		1.280	
Feedback Bias Current	I_B	$V_{IN} = 12\text{V}, I_O = 0.5\text{A}$		50	100	nA
LM2576SX/T-ADJ					500	

Electrical Characteristics (Cont.)

Unless otherwise specified: $V_{IN} = 12V$ for 3.3V, 5V and ADJ options and 25V for 12V option; $V_{OUT} = 5V$ for ADJ option; $T_A = 25^\circ C$; V_{IN} rated = 40V; $I_o = 0.5$ to 3A (LM2576), 0.2 to 1A (LM2575). Values in **bold** apply over full operating temperature range.

Parameter	Symbol	Test Conditions	Min	Typ	Max	Units
Output Voltage LM2575SX/T-3.3	V_o	$I_o = 0.2A$	3.23	3.30	3.37	V
		8V to V_{IN} Rated	3.20		3.40	
			3.14		3.47	
Output Voltage LM2575SX/T-5	V_o	$I_o = 0.2A$	4.90	5.00	5.10	V
		8V to V_{IN} Rated	4.85		5.15	
			4.75		5.25	
Output Voltage LM2576SX/T-12	V_o	$I_o = 0.2A$	11.76	12.00	12.24	V
		15V to V_{IN} Rated	11.52		12.48	
			11.40		12.60	
Feedback Voltage LM2575SX/T-ADJ, $V_o = 5V$	V_{FB}	$I_o = 0.2A$	1.217	1.230	1.243	V
		8V to V_{IN} Rated	1.193		1.267	
			1.180		1.280	
Feedback Bias Current LM2575SX/T-ADJ	I_b	$V_{IN} = 12V, I_o = 0.2A$		50	100	nA
			500			
Efficiency/Option3. 3V 5V 12V ADJ, $V_o = 5V$	η	$V_{IN} = 12V, I_o = 1A$ (LM2575, 3A for LM2576)		77		%
				82		
			$V_{IN} = 15V, I_o = 1A$ (LM2575, 3A for LM2576)	88		
			$V_{IN} = 12V, I_o = 1A$ (LM2575, 3A for LM2576)	82		
Switching Frequency	f_{SX}		47	52	58	kHz
			43		62	
Saturation Voltage ⁽¹⁾	V_{SAT}	LM2575, $I_o = 1A$		0.9	1.2	V
		LM2576, $I_o = 3A$		0.9	1.4	
Max. Duty Cycle (On) ⁽³⁾	DC		93	98		%
Peak Current LM2575 ⁽¹⁾	I_{CL}		1.7	2.2	3.0	A
			1.3		3.2	
Peak Current LM2576 ⁽¹⁾	I_{CL}		4.2	5.8	6.9	A
			3.5		7.5	

Electrical Characteristics (Cont.)

Unless otherwise specified: $V_{IN} = 12V$ for 3.3V, 5V and ADJ options and 25V for 12V option; $V_{OUT} = 5V$ for ADJ option; $T_A = 25^\circ C$; V_{IN} rated = 40V; $I_O = 0.5$ to 3A (LM2576), 0.2 to 1A (LM2575). Values in **bold** apply over full operating temperature range.

Parameter	Symbol	Test Conditions	Min	Typ	Max	Units
Output Leakage Current ⁽²⁾	I_L	$V_N = V_{IN}$ Rated			2	mA
Output = 0V				7.5	30	
Output = -1V						
Quiescent Current ⁽²⁾	I_Q			5	10	mA
Standby Quiescent Current (On/Off Pin = 5V)	I_{STBY}			50		μA
On/Off Pin Logic Input Level	V_{IH}		2.2	1.4		V
			2.4			
	V_{IL}			1.2	1.0	V
					0.8	
On/Off Pin Input Current	I_{IH}	$V_{ON/OFF} = 5V$ (Off)		12	30	μA
	I_{IL}	$V_{ON/OFF} = 0V$ (On)		0	10	

Notes:

- (1) Output sourcing current, resistive load, no inductor or capacitor.
- (2) Feedback = $V_O + 1.0V$.
- (3) Feedback = 0V.

Pin Configurations

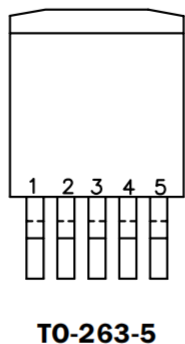
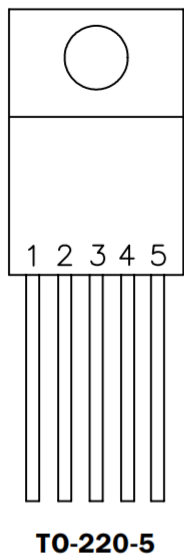

Pin	Function
1	V_{IN}
2	OUTPUT
3	COMMON
4	FEEDBACK
5	ON/OFF
TAB is COMMON	

Ordering Information

(1) -XX = Voltage Option. Available voltages are 3.3V (-3.3), 5V (-5.0), 12V (-12), and ADJ (-ADJ), which is adjustable between 1.23V and 35V.

Block Diagram

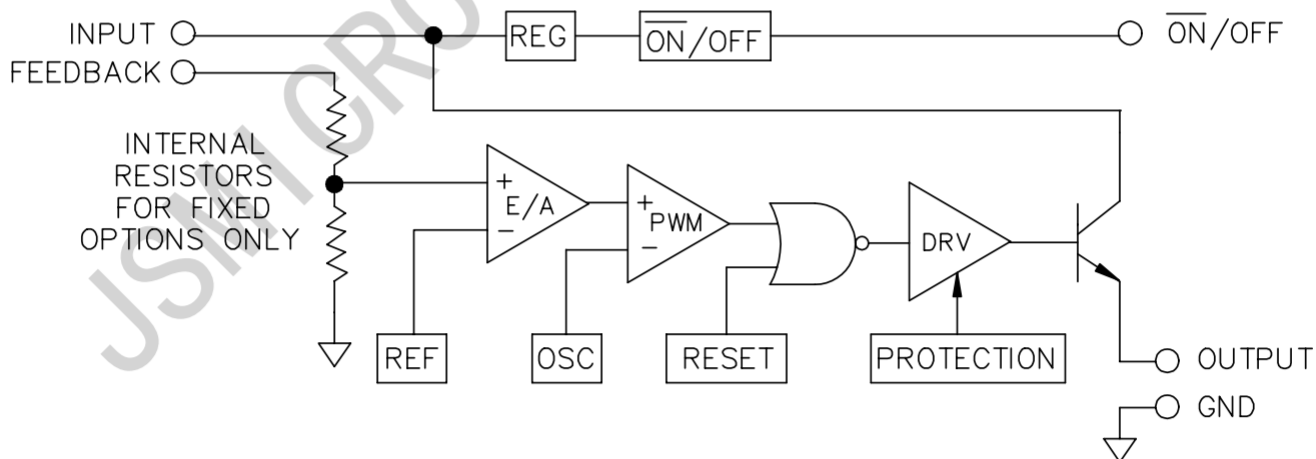

Typical Characteristics - LM2575SX/T

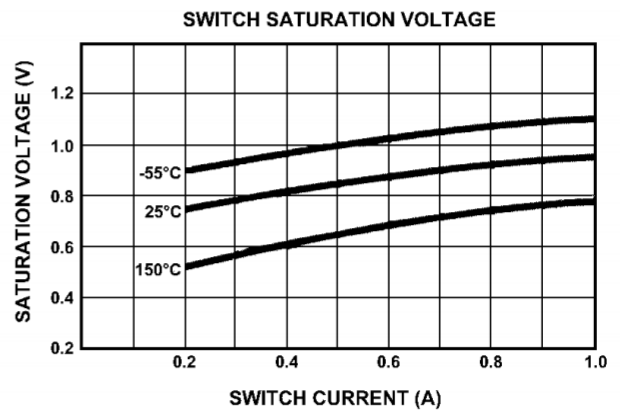
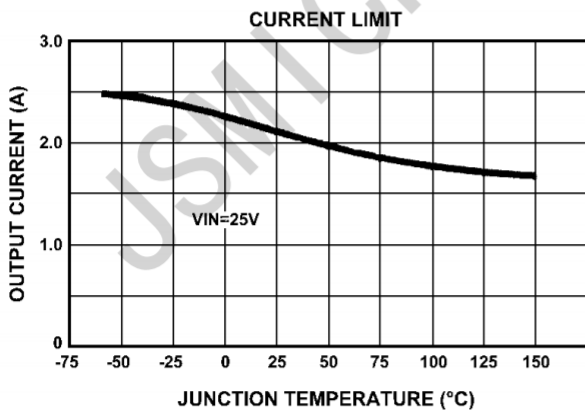
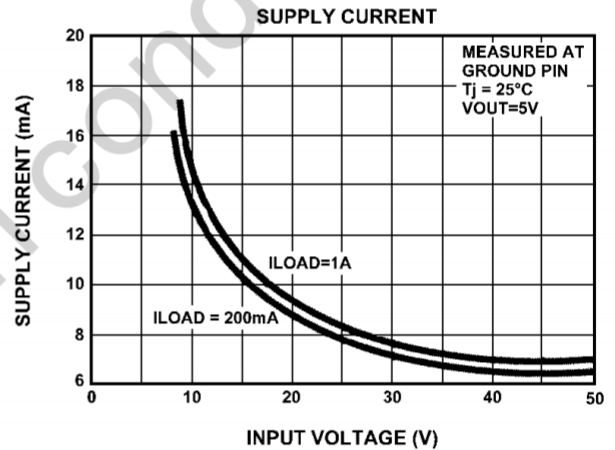
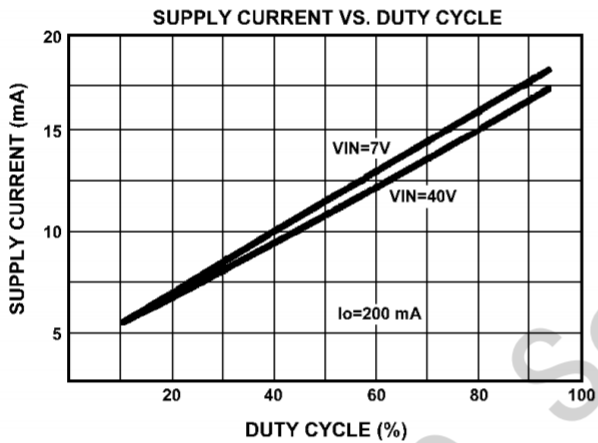
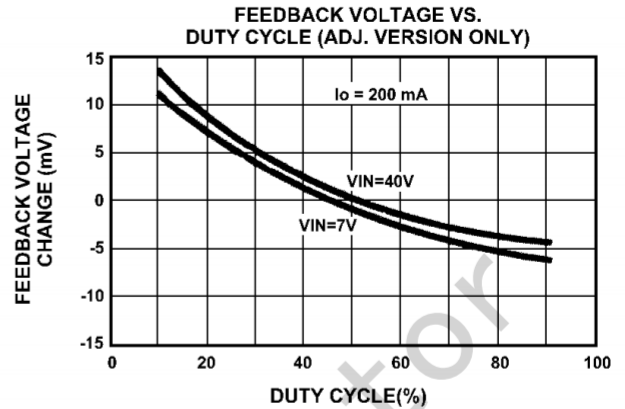
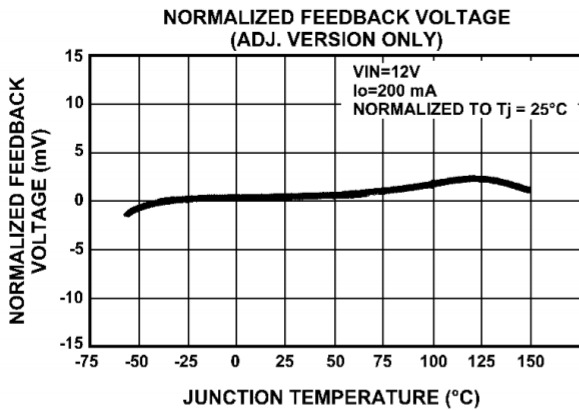

Typical Characteristics - LM2575SX/T (Cont.)

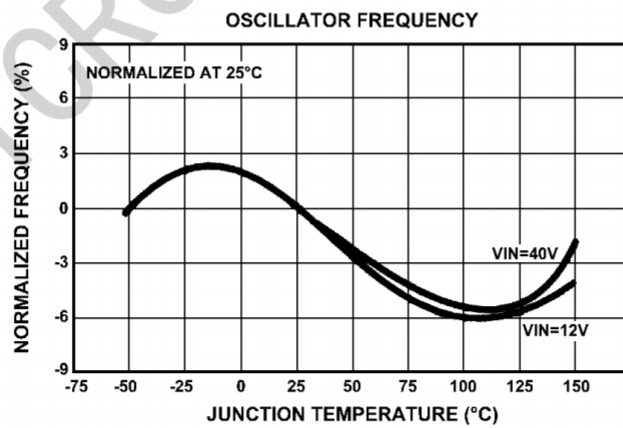
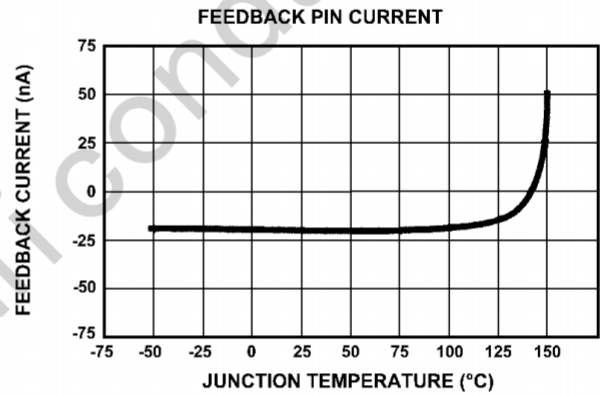
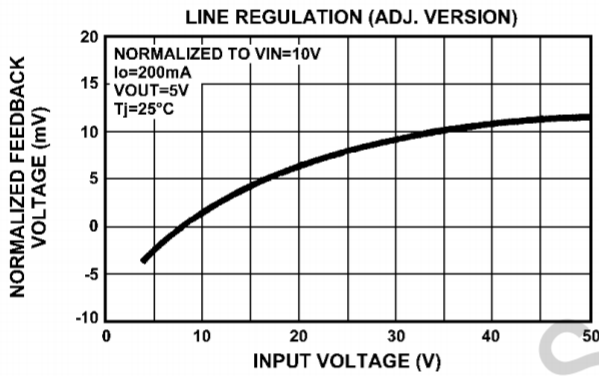
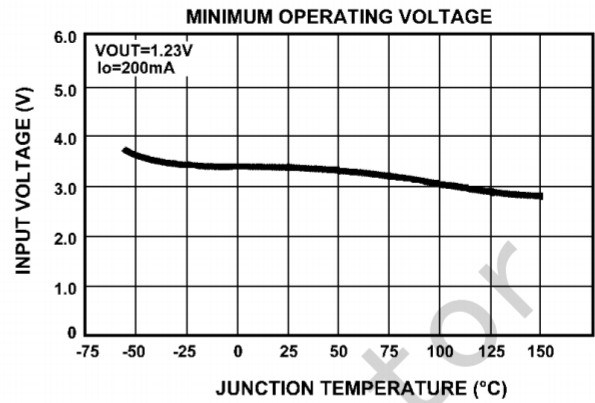
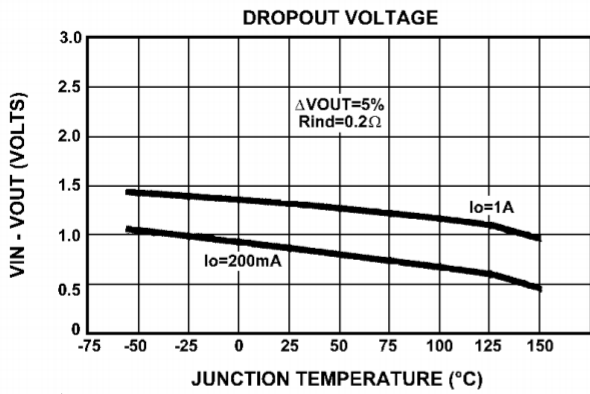

Typical Characteristics - LM2575SX/T (Cont.)

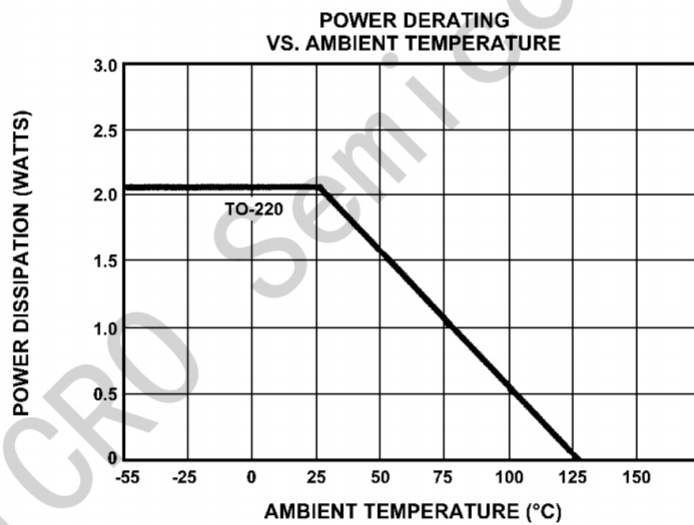
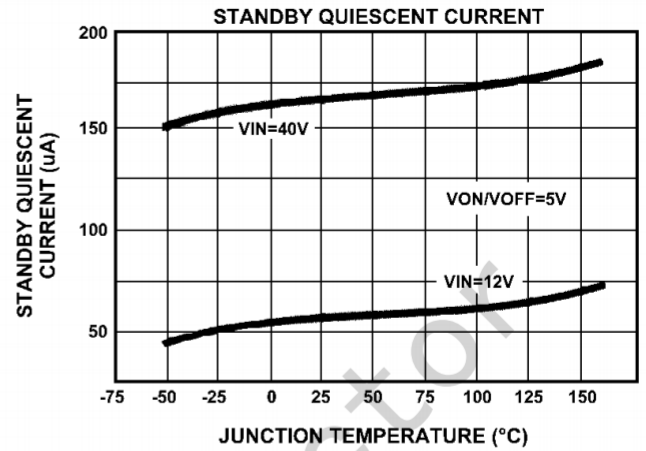
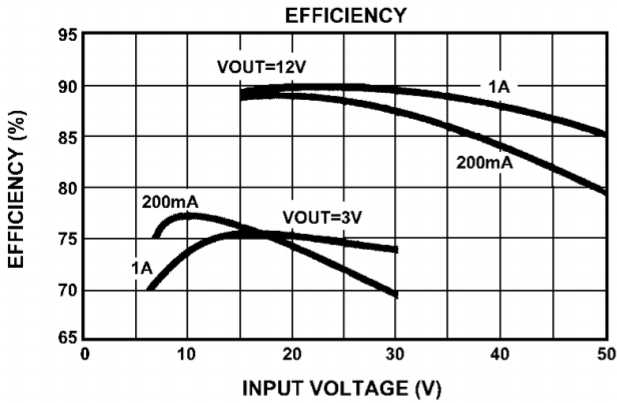

Typical Characteristics - LM2576SX/T

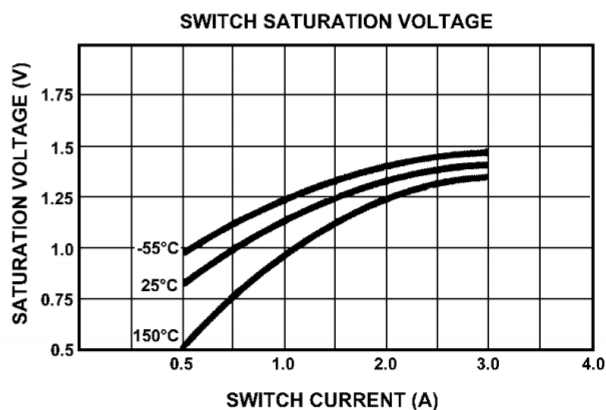
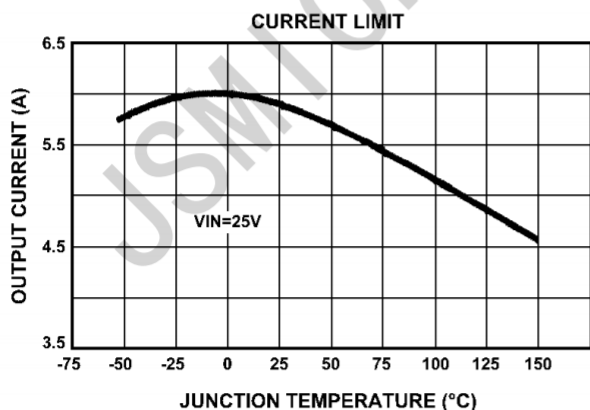
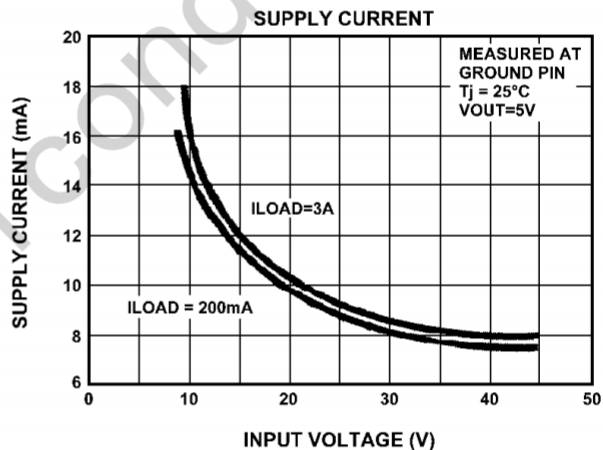
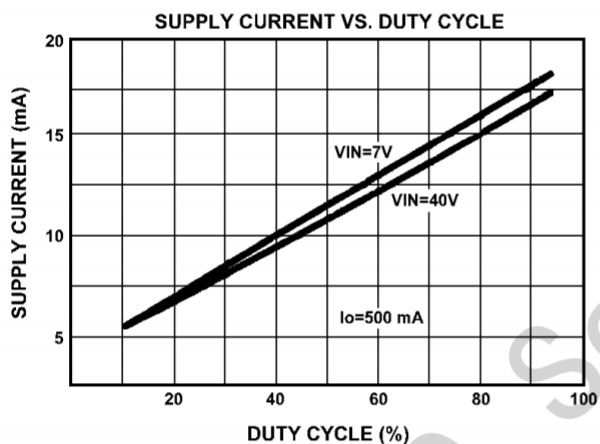
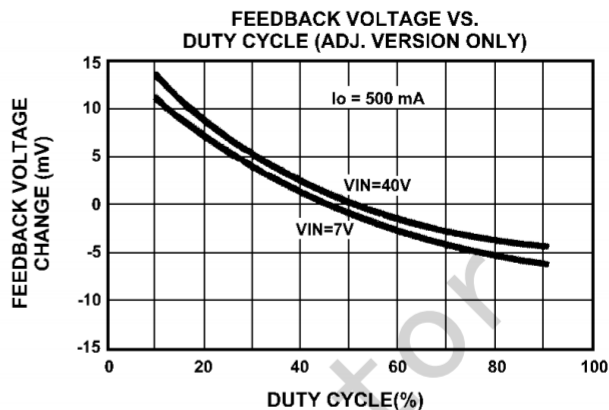
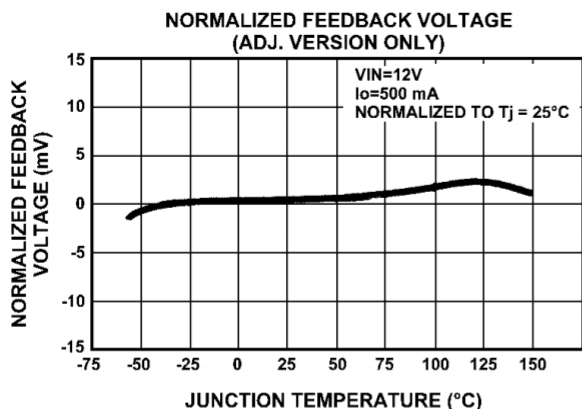

Typical Characteristics - LM2576SX/T (Cont.)

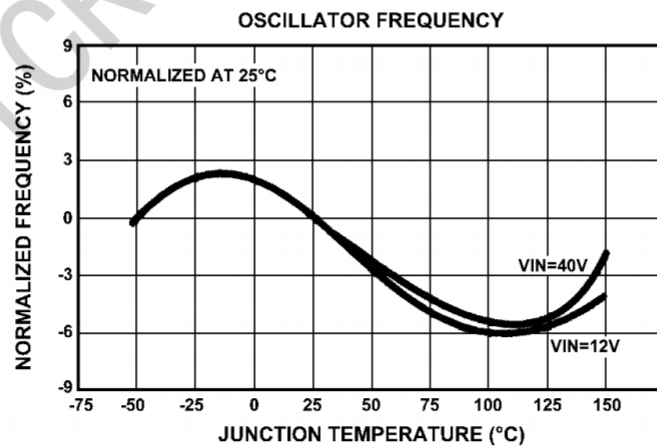
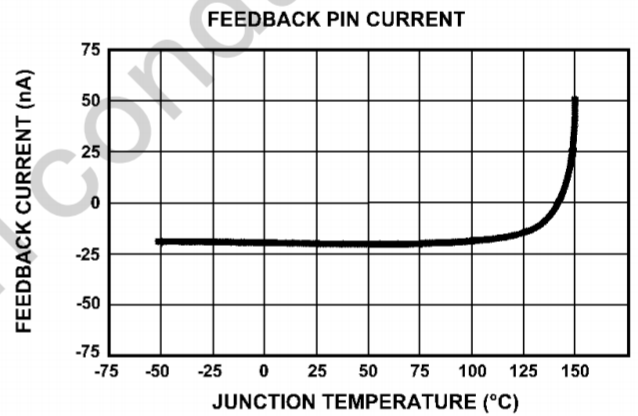
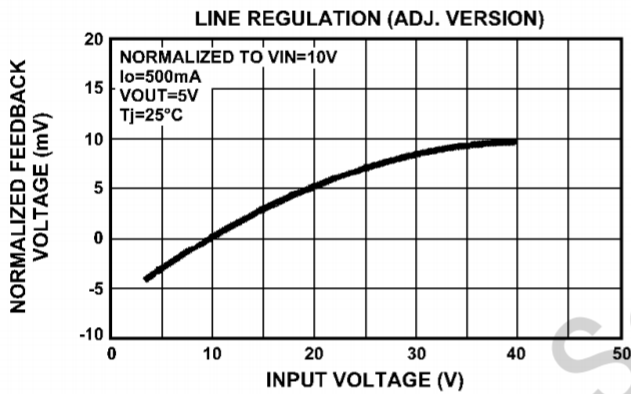
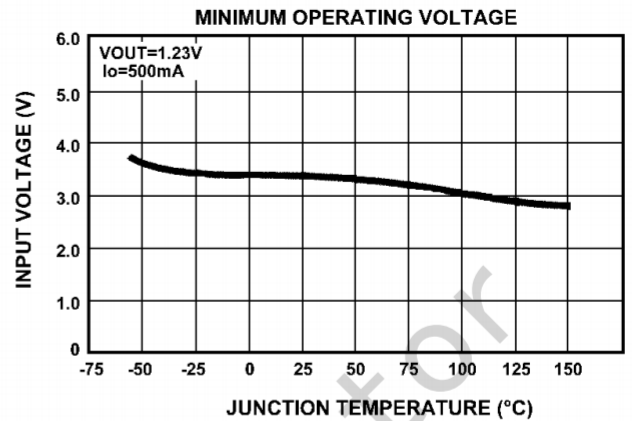
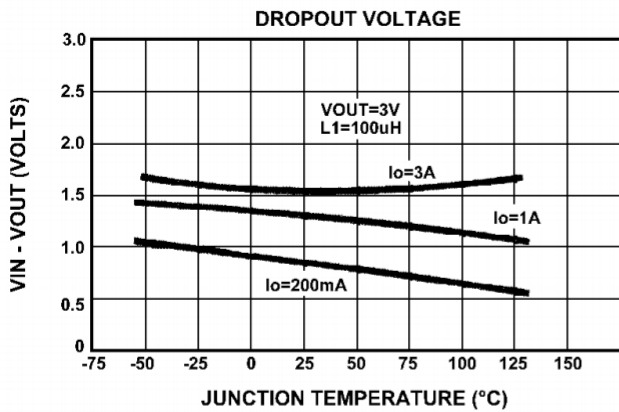

Typical Characteristics - LM2576SX/T (Cont.)

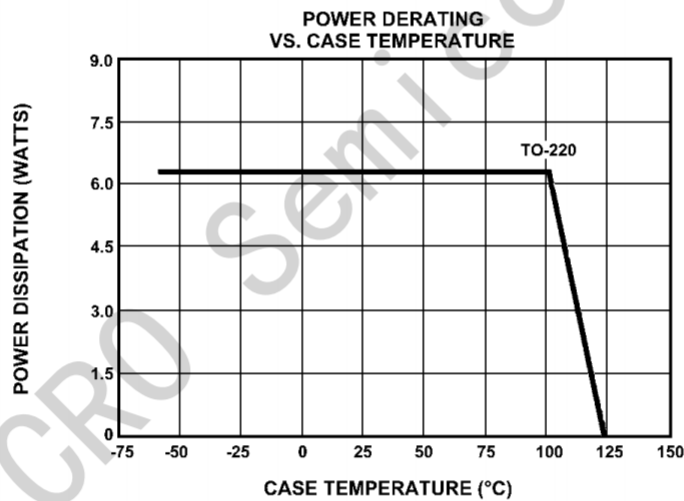
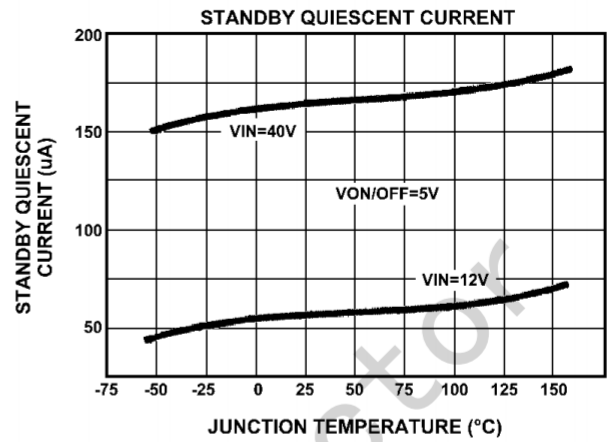
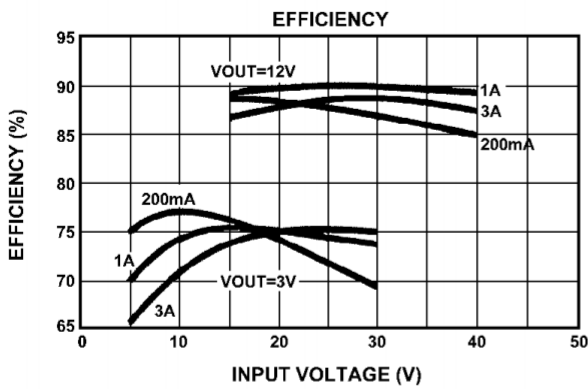

Outline Drawing - TO-220-5

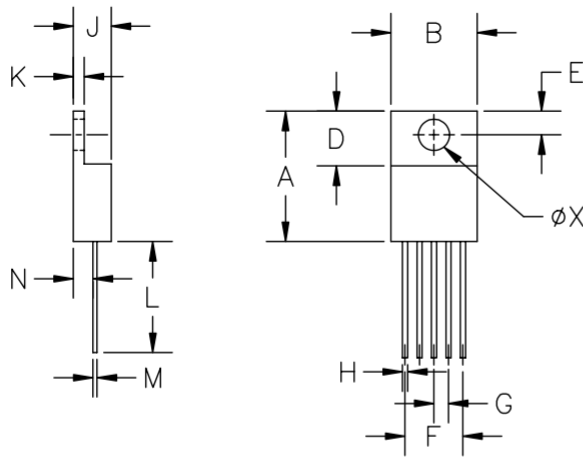

DIM ^N	INCHES		MM		NOTE
	MIN	MAX	MIN	MAX	
A	.560	.650	14.22	16.51	—
B	.380	.420	9.65	10.67	—
D	.230	.260	5.84	6.60	—
E	.100	.135	2.54	3.43	—
F	.263	.273	6.68	6.94	—
G	.062	.072	1.57	1.83	—
H	.025	.040	.63	1.02	—
J	.140	.190	3.55	4.83	—
K	.045	.055	1.14	1.40	—
L	.540	.560	13.72	14.22	—
M	.014	.022	.35	.56	—
N	.080	.120	2.03	3.05	—
φX	.139	.161	3.53	4.09	—

JEDEC TO-220

Outline Drawing - TO-263-5

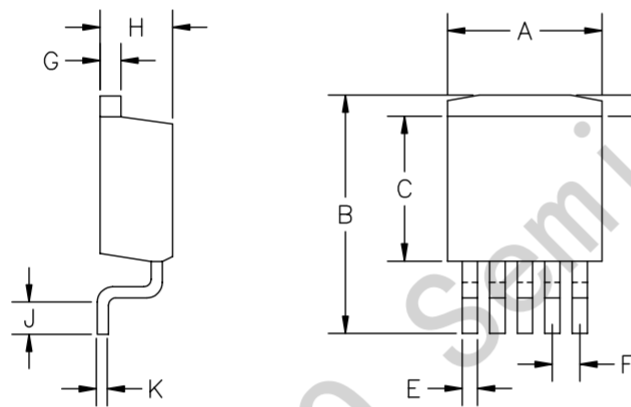

DIM ^N	INCHES		MM		NOTE
	MIN	MAX	MIN	MAX	
A	.380	.405	9.65	10.29	—
B	.575	.625	14.60	15.88	—
C	.325	.380	8.25	9.66	—
D	—	.055	—	1.40	—
E	.020	.039	.50	.99	—
F	.060	.072	1.52	1.83	—
G	.045	.055	1.14	1.40	—
H	.160	.190	4.06	4.83	—
J	.090	.110	2.28	2.80	—
K	.018	.029	.457	.736	—

JEDEC TO-263

Minimum Land Pattern - TO-263-5

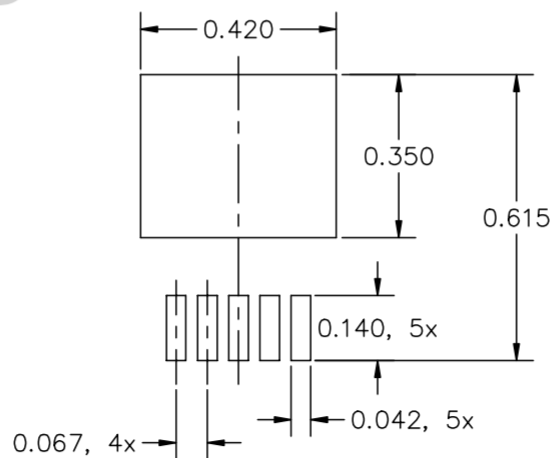

NOTE: ALL DIMENSIONS ARE IN INCHES

X-ON Electronics

Largest Supplier of Electrical and Electronic Components

Click to view similar products for [Isolated DC/DC Converters](#) category:

Click to view products by [JSMSEMI](#) manufacturer:

Other Similar products are found below :

[PSL486-7LR](#) [Q48T30020-NBB0](#) [JAHW100Y1](#) [SPB05C-12](#) [SQ24S15033-PS0S](#) [CE-1003](#) [CE-1004](#) [MAU228](#) [J80-0041NL](#) [DFC15U48D15](#)
[XGS-1205](#) [06322](#) [SPB05B-15](#) [L-DA20](#) [DCG40-5G](#) [XKS-2405](#) [DPA423R](#) [vi-m13-cw-03](#) [VI-L53-CV](#) [24IBX15-50-0ZG](#) [HZZ01204-G](#)
[SPU02L-09](#) [SPU02M-09](#) [SPU02N-09](#) [QUINT4-BUFFER/24DC/40](#) [QUINT4-CAP/24DC/5/4KJ](#) [73-551-5039I](#) [DFC15U48D15G](#) [SEN-6471-](#)
[1EM](#) [AHV2815DF/HBB](#) [MI-LC21-IX](#) [PAH-48/8.5-D48NB1-C](#) [BM3020-7A](#) [QRS2050P025R06](#) [QRS2050P025K00](#) [CM2320-9EG](#)
[SKMW15F-05](#) [V300A28H400BF3](#) [TEN 15-1223](#) [TEQ 100-2418WIR](#) [TEQ 160-7218WIR](#) [R05C05TE05S-R](#) [HQA2W085W033V-N07-S](#)
[AM1SS-2405SJZ](#) [AM2DS-1224SJZ](#) [AM2DS-2405DJZ](#) [AM10SBO-4824SNZ-B](#) [AM15E-2405S-NZ](#) [AM2DS-1212SJZ](#) [AM30SBO-](#)
[4805SNZ-B](#)