

## DUAL OPERATIONAL AMPLIFIER

### DESCRIPTION

The LM358 consists of two independent high gain, internally frequency compensated operational amplifier. It can be operated from a single power supply and also split power supplies.

### FEATURES

- \*Internally frequency compensated for unity gain.
- \*Wide power supply range 3V - 32V.
- \*Input common-mode voltage range include ground.
- \*Large DC voltage gain.

### APPLICATIONS

- \*General purpose amplifier.
- \*Transducer amplifier.

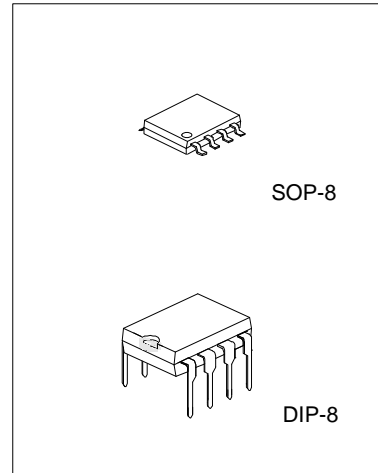

### PIN CONFIGURATIONS

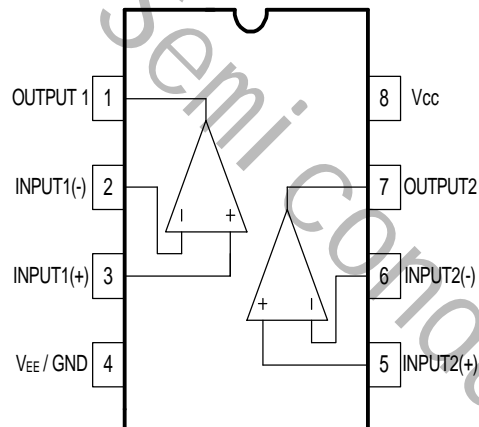

## BLOCK DIAGRAM

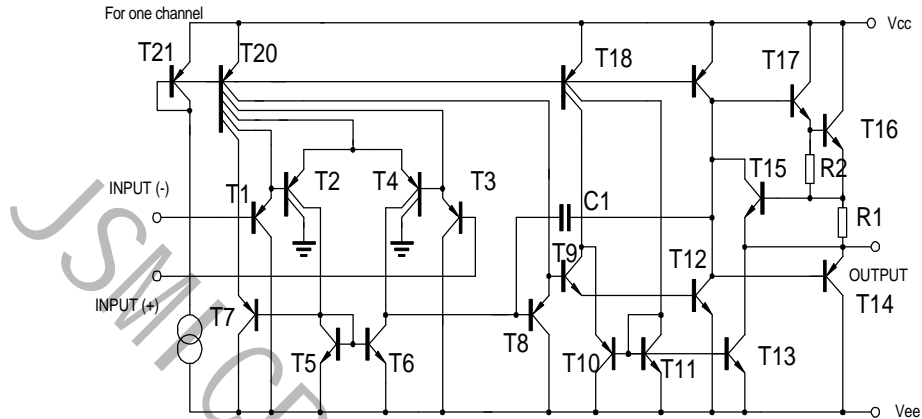

## ABSOLUTE MAXIMUM RATINGS

PARAMETER	SYMBOL	VALUE	UNIT
Supply Voltage	$V_{CC}$	+16 or 32	V
Differential Input Voltage	$V_I(\text{DIFF})$	32	V
Input Voltage	$V_I$	-0.3 ~ +32	V
Output Short to Ground		Continuous	
Operating Temperature Range	TOPR	0 ~ +70	°C
Storage Temperature Range	TSTG	-65 ~ +150	°C

**ELECTRICAL CHARACTERISTICS** ( $V_{CC}=5.0V, V_{EE}=GND, T_A=25^{\circ}C$ , unless otherwise specified) ©

PARAMETER	SYMBOL	TEST CONDITION	MIN	TYP	MAX	UNIT
Input Offset Voltage	VIO	VCM=0V to VCC-1.5V VO(P)=1.4V, RS=0Ω		2.9	7.0	mV
Input Offset Current	IIO			5	50	nA
Input Bias Current	IBIAS			45	250	nA
Input Common Mode Voltage	VI(R)	VCC=30V	0		VCC-1.5	V
Power Supply Current	ICC	RL=∞, VCC=30V		0.8	2.0	mA
		RL=∞, Full Temperature Range		0.5	1.2	mA
Large Signal Voltage Gain	GV	VCC=15V, RL>=2KΩ VO(P)=1V to 11V	25	100		V/mV
Output Voltage Swing	VO(H)	VCC=30V, RL=2KΩ	26			V
		VCC=30V, RL=10KΩ	27	28		V
	VO(L)	VCC=5V, RL>=10KΩ		5	20	mV
Common Mode Rejection Ratio	CMRR		65	80		dB
Power Supply Rejection Ratio	PSRR		65	100		dB
Channel Separation	CS	f=1KHZ to 20KHZ		120		dB
Short Circuit Current to Ground	ISC			40	60	mA
Output Current	ISOURCE	VI(+)=1V, VI(-)=0V VCC=15V, VO(P)=2V	20	30		mA
	ISINK	VI(+)=0V, VI(-)=1V VCC=15V, VO(P)=2V	10	15		mA
		VI(+)=0V, VI(-)=1V VCC=15V, VO(P)=200mV	12	100		mA
Differential Input Voltage	VI(DIFF)				VCC	V

## TYPICAL PERFORMANCE CHARACTERISTICS

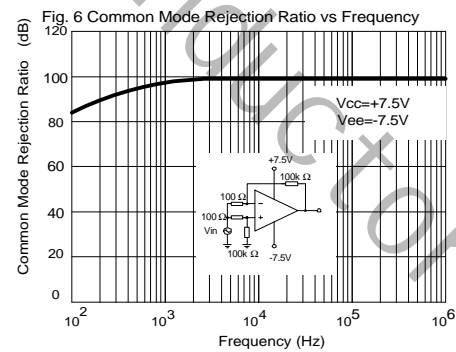
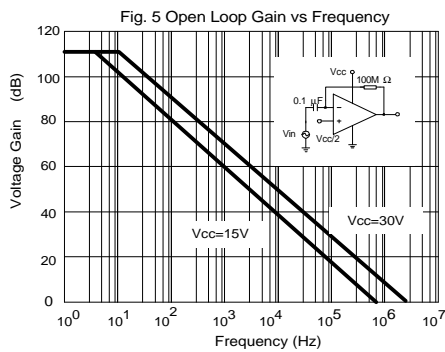
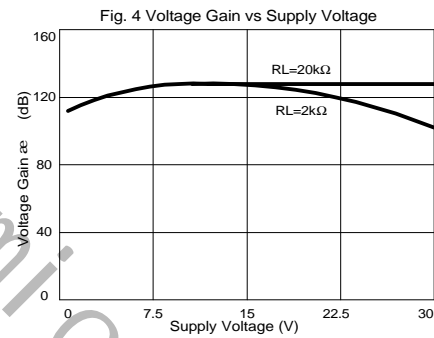
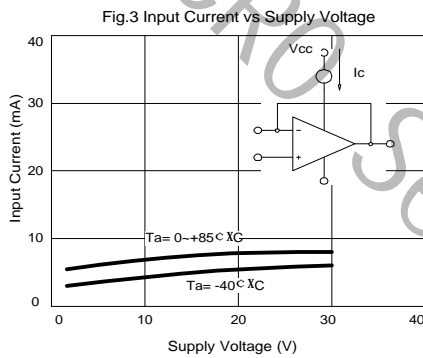
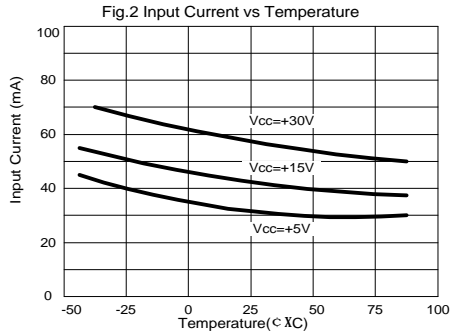
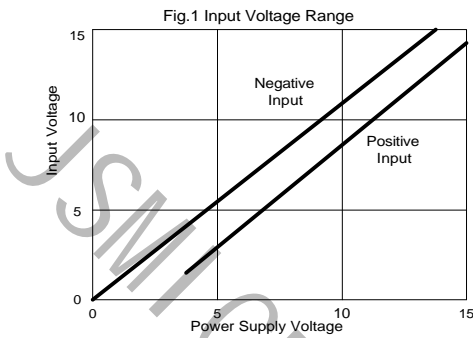

Fig. 7 Voltage Follower Pulse Response

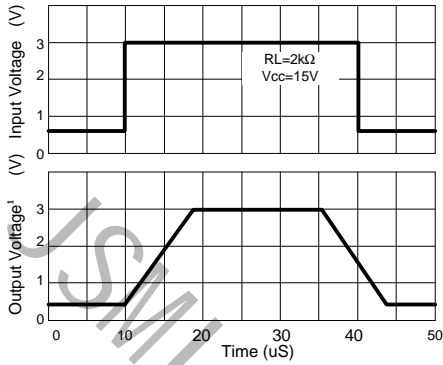

Fig. 8 Voltage Follower Response (Small Signal)

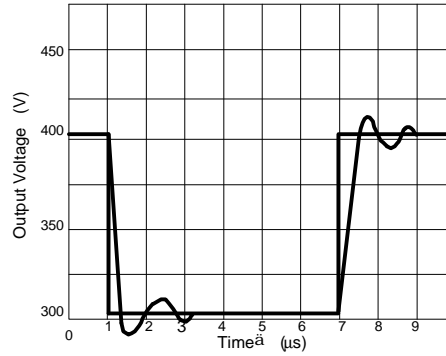

Fig. 9 Gain vs Large Signal Frequency

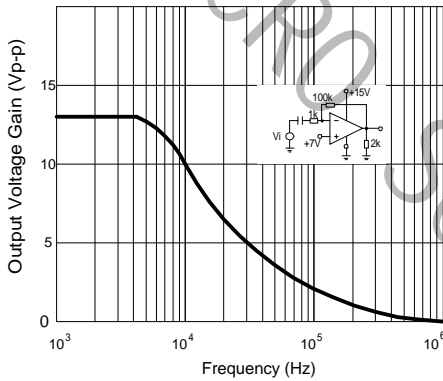

Fig. 10 Output Current Sinking vs Output Voltage

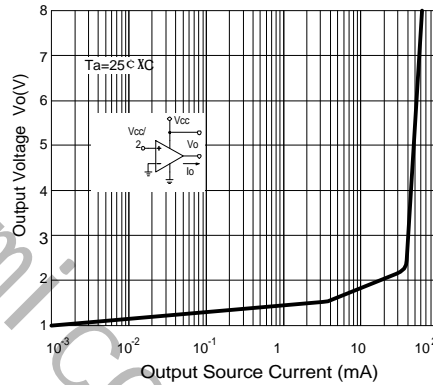

Fig. 11 Output Sink Current vs Output Voltage

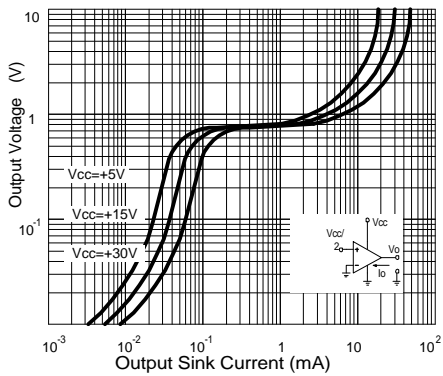
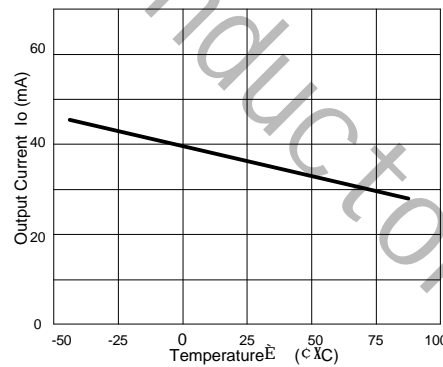

Fig. 12 Current Limiting vs Temperature



## X-ON Electronics

Largest Supplier of Electrical and Electronic Components

*Click to view similar products for [Operational Amplifiers - Op Amps](#) category:*

*Click to view products by [JSMSEMI](#) manufacturer:*

Other Similar products are found below :

[430227FB](#) [UPC451G2-A](#) [UPC824G2-A](#) [LT1678IS8](#) [UPC258G2-A](#) [NCV33202DMR2G](#) [NJM324E](#) [M38510/13101BPA](#) [NTE925](#)  
[AZV358MTR-G1](#) [AP4310AUMTR-AG1](#) [AZV358MMTR-G1](#) [SCY33178DR2G](#) [NCV5652MUTWG](#) [NCV20034DR2G](#) [NTE778S](#) [NTE871](#)  
[NTE937](#) [MCP6V16UT-E/OT](#) [SCY6358ADR2G](#) [UPC4570G2-E1-A](#) [NCS20282FCTTAG](#) [UPC834G2-E1-A](#) [UPC1458G2-E2-A](#) [UPC813G2-](#)  
[E2-A](#) [UPC458G2-E1-A](#) [UPC824G2-E2-A](#) [UPC4574G2-E2-A](#) [UPC4558G2-E2-A](#) [UPC4560G2-E1-A](#) [UPC258G2-E1-A](#) [UPC4742GR-9LG-](#)  
[E1-A](#) [UPC4742G2-E1-A](#) [UPC832G2-E2-A](#) [UPC842G2-E1-A](#) [UPC802G2-E1-A](#) [UPC4741G2-E2-A](#) [UPC4572G2-E2-A](#) [UPC844GR-9LG-](#)  
[E2-A](#) [UPC259G2-E1-A](#) [UPC4741G2-E1-A](#) [UPC4558G2-E1-A](#) [UPC1251GR-9LG-E1-A](#) [UPC4744G2-E1-A](#) [UPC4092G2-E1-A](#)  
[UPC4574G2-E1-A](#) [UPC4062G2-E2-A](#) [UPC451G2-E2-A](#) [UPC832G2-E1-A](#) [UPC844GR-9LG-E1-A](#)