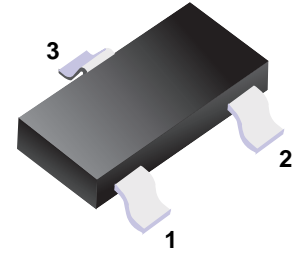
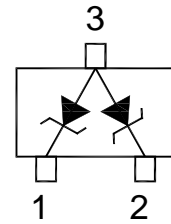


**■ Features**

- Allows Either Two Separate Unidirectional Configurations or a Single Bidirectional Configurations.
- Low Leakage Current.
- 24-40 Watts Peak Power Protection.
- Excellent Clamping Capability.
- ESD Rating of Class N(exceeding 16KV)per the Human Body Model.
- Transient Voltage Suppressors Encapsulated in a SOT-23 Package.


**■ Simplified outline(SOT-23)**

**■ Mechanical Data**

- Case: Molded Epoxy
- Marking: Marking Code
- Maximum Case Temperature for Soldering Purpose: 260 C for 10 sec.
- Weight: 0.008grams(approx.)

**■ Absolute Maximum Ratings  $T_a = 25^\circ\text{C}$** 

Characteristics	Symbol	Value	
Peak Power Dissipation @ 1.0 ms @ $T_L \leq 25^\circ\text{C}$ <sup>(1)</sup> MMBZ5V6A thru MMBZ10VA MMBZ12VA thru MMBZ33VA	$P_{PK}$	24 40	W
Total Power Dissipation on FR-5 Board <sup>(2)</sup> @ $T_A = 25^\circ\text{C}$ Derate above $25^\circ\text{C}$ Thermal Resistance Junction-to-Ambient	$P_D$ $R_{\theta JA}$	225 1.8 556	mW mW/ $^\circ\text{C}$ $^\circ\text{C}/\text{W}$
Total Power Dissipation on Alumina Substrate <sup>(3)</sup> @ $T_A = 25^\circ\text{C}$ Derate above $25^\circ\text{C}$ Thermal Resistance Junction-to-Ambient	$P_D$ $R_{\theta JA}$	300 2.4 417	mW mW/ $^\circ\text{C}$ $^\circ\text{C}/\text{W}$
Junction and Storage Temperature Range	$T_J, T_{STG}$	-55 to +150	$^\circ\text{C}$
Lead Solder Temperature-Maximum(10 Second Duration)	$T_L$	260	$^\circ\text{C}$

NOTE: 1. Non-Repetitive Current Pulse, per FIG 5 and Derated above  $T_A = 25^\circ\text{C}$  per FIG 6.

2. FR-5=1.0×0.75×0.62 in.

3. Alumina=0.4×0.3×0.024m, 99.5% alumina

**ELECTRICAL CHARACTERISTICS** ( $T_A = 25^\circ\text{C}$  unless otherwise noted)  
**UNIDIRECTIONAL** (Circuit tied to Pins 1 and 3 or Pins 2 and 3)

 $(V_F = 0.9\text{ V Max @ } I_F = 10\text{ mA})$ 
**24 WATTS**

Device	Device Marking	$V_{RWM}$ Volts	$I_R @ V_{RWM}$ $\mu\text{A}$	Breakdown Voltage			Max Zener Impedance <sup>(5)</sup>			$V_C @ I_{PP}$ <sup>(6)</sup>		$\theta_{V_{BR}}$ $\text{mV}/^\circ\text{C}$	
				$V_{BR}^{(4)} \text{ (V)}$			$@ I_T$	$Z_{ZT} @ I_{ZT}$	$Z_{ZK} @ I_{ZK}$	$V_C$	$I_{PP}$		
				Min	Nom	Max	$\text{mA}$	$\Omega$	$\Omega$	$\text{mA}$	V		A
MMBZ5V6A	5A6	3.0	5.0	5.32	5.6	5.88	20	11	1600	0.25	8.0	3.0	1.26
MMBZ6V2A	6A2	3.0	0.5	5.89	6.2	6.51	1.0	-	-	-	8.7	2.76	2.80
MMBZ6V8A	6A8	4.5	0.5	6.46	6.8	7.14	1.0	-	-	-	9.6	2.5	3.4
MMBZ9V1A	9A1	6.0	0.3	8.65	9.1	9.56	1.0	-	-	-	14	1.7	7.5
MMBZ10VA	10A	6.5	0.3	9.50	10	10.5	1.0	-	-	-	14.2	1.7	7.5

 $(V_F = 0.9\text{ V Max @ } I_F = 10\text{ mA})$ 
**40 WATTS**

Device	Device Marking	$V_{RWM}$ Volts	$I_R @ V_{RWM}$ nA	Breakdown Voltage			$V_C @ I_{PP}^{(6)}$		$\theta_{V_{BR}}$ $\text{mV}/^\circ\text{C}$	
				$V_{BR}^{(4)} \text{ (V)}$			$@ I_T$	$V_C$		$I_{PP}$
				Min	Nom	Max	$\text{mA}$	V		A
MMBZ12VA	12A	8.5	200	11.40	12	12.60	1.0	17	2.35	7.5
MMBZ15VA	15A	12	50	14.25	15	15.75	1.0	21	1.9	12.3
MMBZ18VA	18A	14.5	50	17.10	18	18.90	1.0	25	1.6	15.3
MMBZ20VA	20A	17	50	19.00	20	21.00	1.0	28	1.4	17.2
MMBZ27VA	27A	22	50	25.65	27	28.35	1.0	40	1.0	24.3
MMBZ33VA	33A	26	50	31.35	33	34.65	1.0	46	0.87	30.4

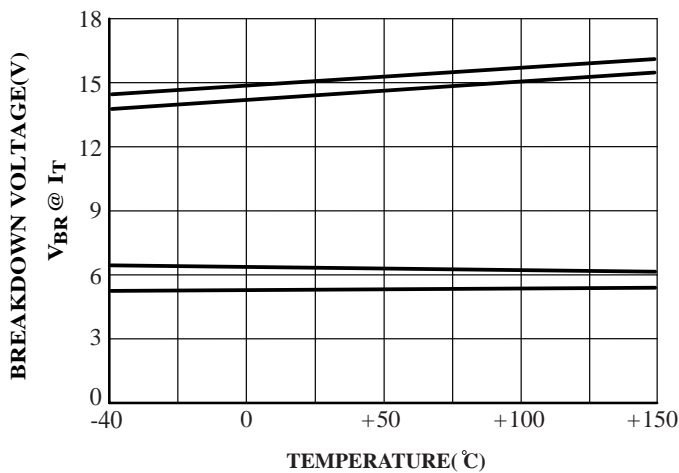
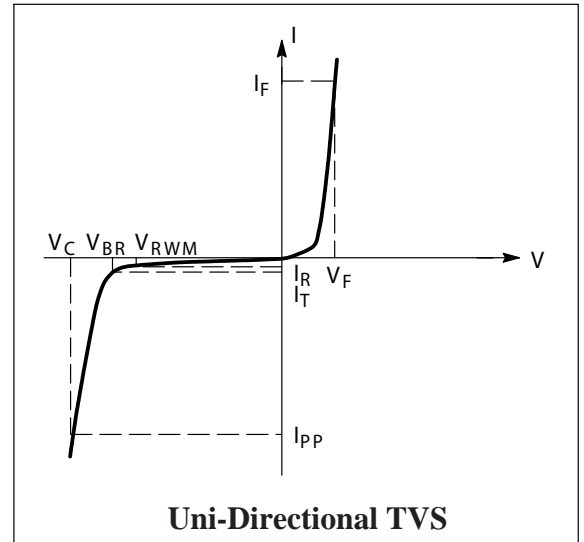
- $V_{BR}$  measured at pulse test current  $I_T$  at an ambient temperature of  $25^\circ\text{C}$ .
- $Z_{ZT}$  and  $Z_{ZK}$  are measured by dividing the AC voltage drop across the device by the AC current applied. The specified limits are for  $I_{Z(AC)} = 0.1 I_{Z(DC)}$ , with the AC frequency = 1.0 kHz.
- Surge current waveform per Fig 5 and derate per Fig 6

### Electrical Characteristics

( $T_A = 25^\circ\text{C}$  unless otherwise noted)

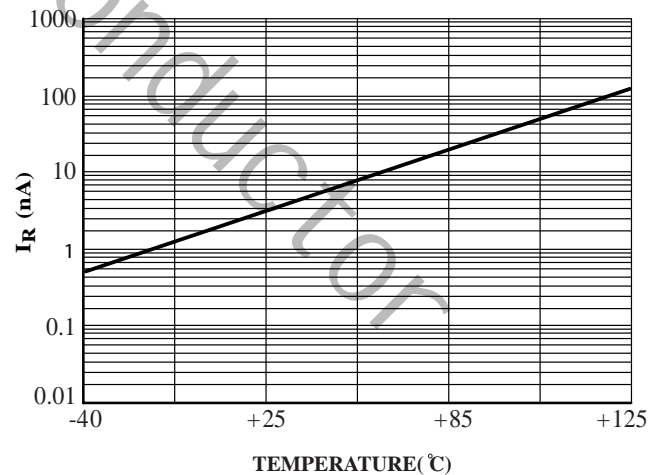
**UNIDIRECTIONAL** (Circuit tied to Pins 1 and 3 or 2 and 3)

Symbol	Parameter
$I_{PP}$	Maximum Reverse Peak Pulse Current
$V_C$	Clamping Voltage @ $I_{PP}$
$V_{RWM}$	Working Peak Reverse Voltage
$I_R$	Maximum Reverse Leakage Current @ $V_{RWM}$
$\theta V_{BR}$	Breakdown Voltage @ $I_T$
$I_T$	Test Current
$V_{BR}$	Maximum Temperature Coefficient of $V_{BR}$
$I_F$	Forward Current
$V_F$	Forward Voltage @ $I_F$
$Z_{ZT}$	Maximum Zener Impedance @ $I_{ZT}$
$I_{ZK}$	Reverse Current
$Z_{ZK}$	Maximum Zener Impedance @ $I_{ZK}$

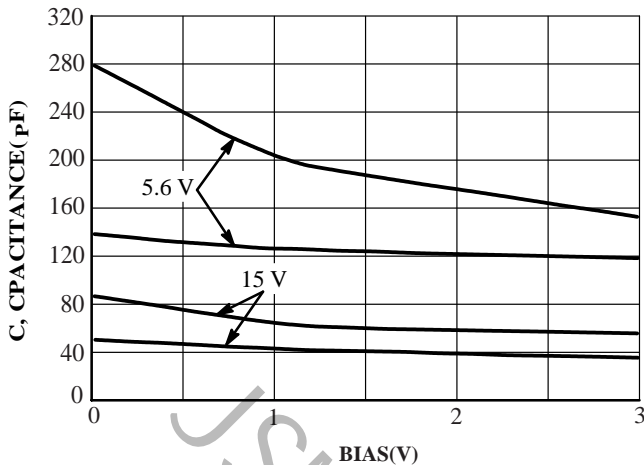


**FIG.1 Typical Breakdown Voltage Versus Temperature**

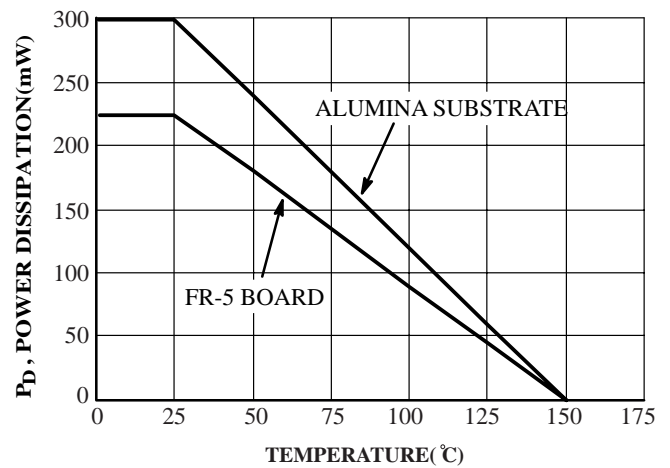
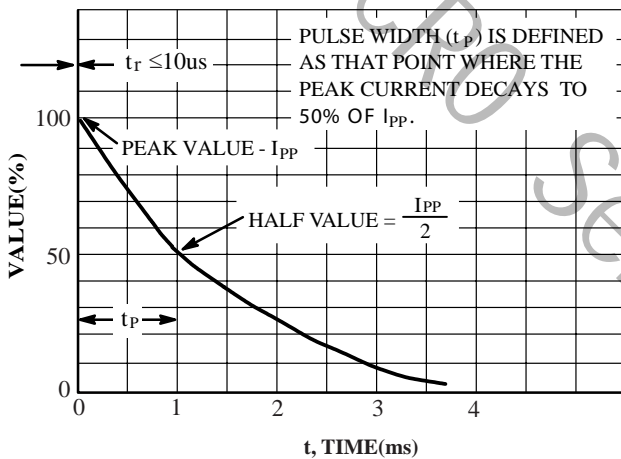
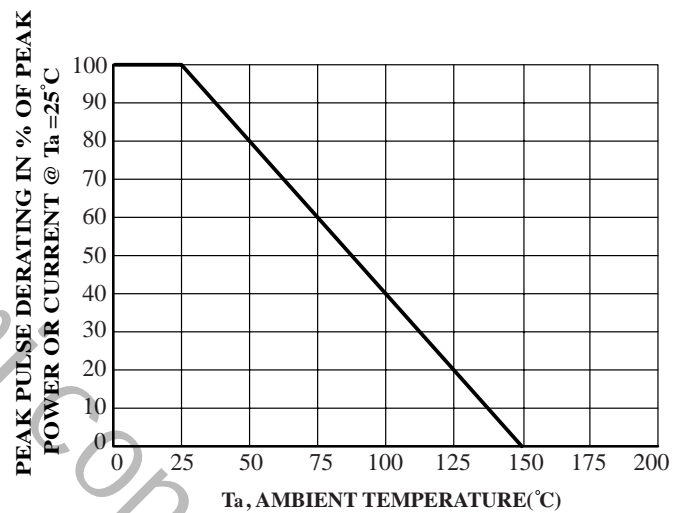
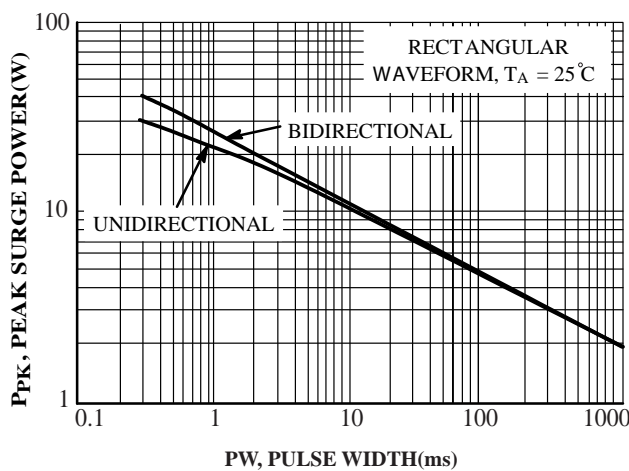
(Upper curve for each voltage is bidirectional mode,  
 lower curve is unidirectional mode)



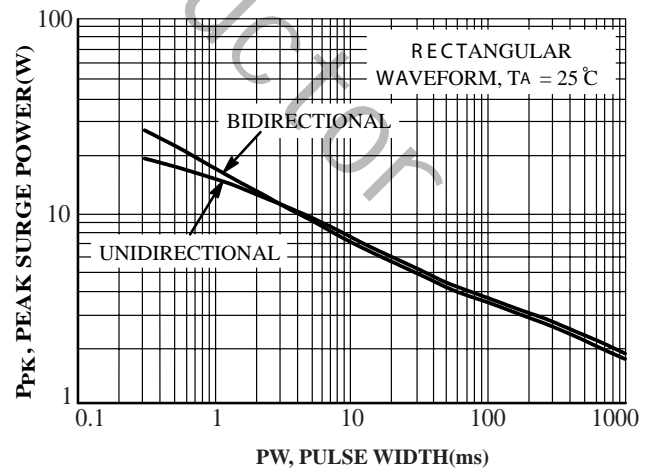
**FIG.2 Typical Leakage Current Versus Temperature**


**FIG.3 Typical Capacitance Versus Bias Voltage**

(Upper curve for each voltage is bidirectional mode,  
 lower curve is unidirectional mode)

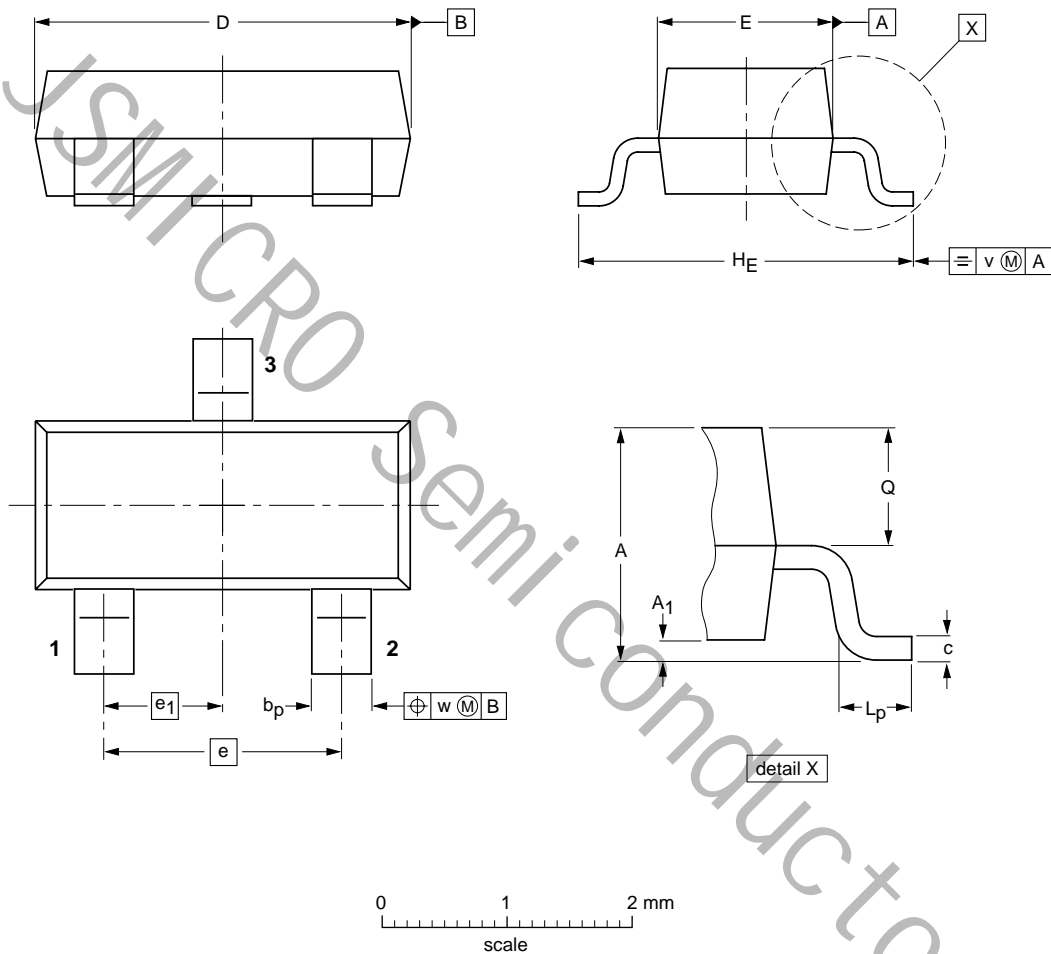

**FIG.4 Steady State Power Derating Curve**

**FIG.5 Pulse Waveform**

**FIG.6 Pulse Derating Curve**

**FIG.7 Maximum Non-repetitive Surge Power, PPK Versus PW**

Power is defined as  $V_{RSM} \times I_Z(pk)$  where  $V_{RSM}$  is the clamping voltage at  $I_Z(pk)$ .


**FIG.8 Maximum Non-repetitive Surge Power, PPK(NOM) Versus PW**

Power is defined as  $V_Z(NOM) \times I_Z(pk)$  where  $V_Z(NOM)$  is the nominal Zener voltage measured at the low test current used for voltage classification

■ SOT-23



DIMENSIONS (mm are the original dimensions)

UNIT	A	A <sub>1</sub> max.	b <sub>p</sub>	c	D	E	e	e <sub>1</sub>	H <sub>E</sub>	L <sub>p</sub>	Q	v	w
mm	1.1 0.9	0.1	0.48 0.38	0.15 0.09	3.0 2.8	1.4 1.2	1.9	0.95	2.5 2.1	0.45 0.15	0.55 0.45	0.2	0.1

## X-ON Electronics

Largest Supplier of Electrical and Electronic Components

*Click to view similar products for [ESD Suppressors / TVS Diodes](#) category:*

*Click to view products by [JSMSEMI](#) manufacturer:*

Other Similar products are found below :

[60KS200C](#) [D18V0L1B2LP-7B](#) [D5V0F4U5P5-7](#) [DESD5V0U1BB-7](#) [NTE4902](#) [P4KE27CA](#) [P6KE11CA](#) [P6KE39CA-TP](#) [P6KE8.2A](#)  
[SA110CA](#) [SA60CA](#) [SA64CA](#) [SMBJ12CATR](#) [SMBJ33CATR](#) [SMBJ8.0A](#) [ESD101-B1-02ELS E6327](#) [ESD105-B1-02EL E6327](#) [ESD112-B1-02EL E6327](#) [ESD119B1W01005E6327XTSA1](#) [ESD5V0L1B02VH6327XTSA1](#) [ESD7451N2T5G](#) [19180-510](#) [CPDT-5V0USP-HF](#)  
[3.0SMCJ33CA-F](#) [3.0SMCJ36A-F](#) [HSPC16701B02TP](#) [D3V3Q1B2DLP3-7](#) [D55V0M1B2WS-7](#) [DESD5V0U1BL-7B](#) [DRTR5V0U4SL-7](#)  
[SCM1293A-04SO](#) [ESD200-B1-CSP0201 E6327](#) [SM12-7](#) [SMF8.0A-TP](#) [SMLJ45CA-TP](#) [CEN955 W/DATA](#) [82350120560](#) [VESD12A1A-](#)  
[HD1-GS08](#) [CPDUR5V0R-HF](#) [CPDQC5V0U-HF](#) [CPDQC5V0USP-HF](#) [CPDQC5V0-HF](#) [D1213A-01LP4-7B](#) [D1213A-02WL-7](#)  
[1SMB33CAT3G-XYZ](#) [MMAD1108/TR13](#) [5KP100A](#) [5KP15A](#) [5KP18A](#) [5KP48A](#)