

RB520S-30

FEATURES

- Low $I_R=0.1\mu A$.
- High reliability.
- Small surface mounting.

APPLICATIONS

- Low current rectification.

ORDERING INFORMATION

| Type No. | Marking | Package Code |
|-----------|---------|--------------|
| RB520S-30 | B | SOD-523 |

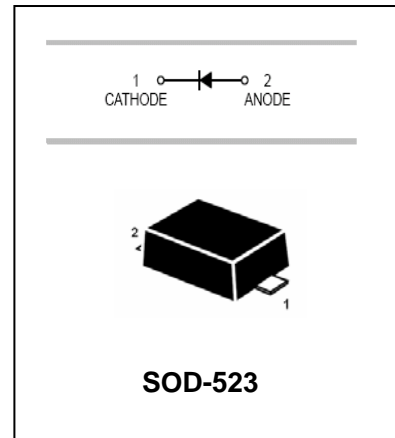

MAXIMUM RATING @ $T_a=25^\circ C$ unless otherwise specified

| Parameter | Symbol | Limits | Unit |
|----------------------------|-----------|---------|------------|
| DC reverse voltage | V_R | 40 | V |
| Mean rectifying current | I_O | 200 | mA |
| Peak forward surge current | I_{FSM} | 1 | A |
| Junction temperature | T_j | 125 | $^\circ C$ |
| Storage temperature | T_{stg} | -40-125 | $^\circ C$ |

ELECTRICAL CHARACTERISTICS @ $T_a=25^\circ C$ unless otherwise specified

| Parameter | Symbol | Min. | Typ. | Max. | Unit | Conditions |
|-----------------|--------|------|------|------|---------|-------------|
| Forward voltage | V_F | | | 0.39 | V | $I_F=10mA$ |
| | | | | 0.55 | V | $I_F=100mA$ |
| Reverse current | I_R | | | 1 | μA | $V_R=10V$ |

TYPICAL CHARACTERISTICS @ $T_a=25^\circ C$ unless otherwise specified

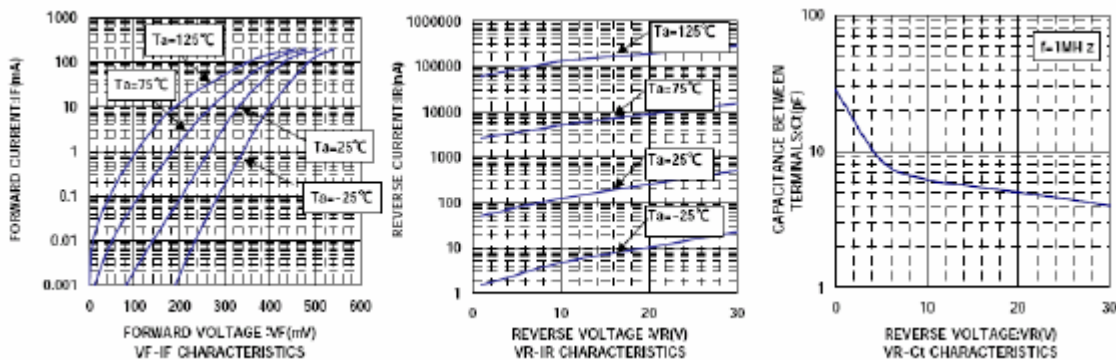

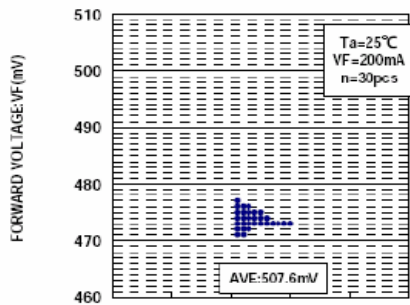

VF DISPERSION MAP

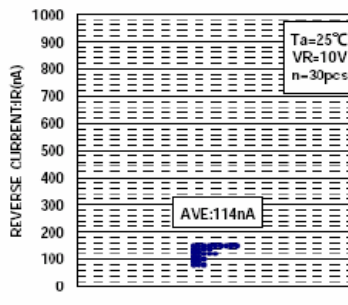

IR DISPERSION MAP

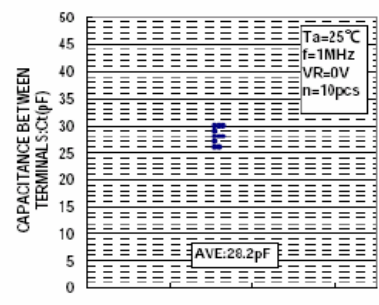

Ct DISPERSION MAP

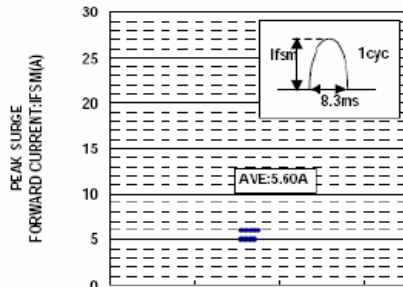

IFSM DISERSION MAP

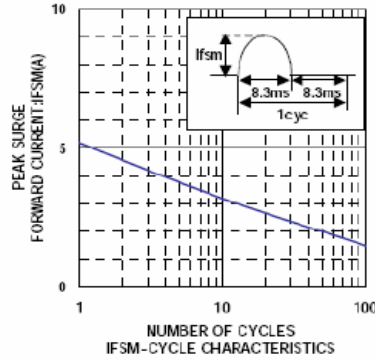

IFSM-CYCLE CHARACTERISTICS

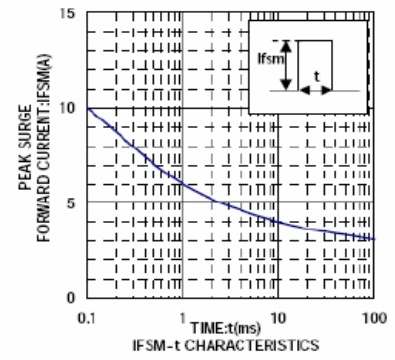

IFSM-t CHARACTERISTICS

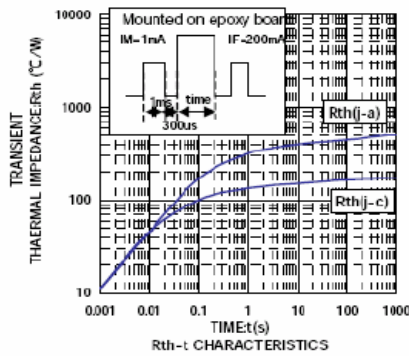

Rth-t CHARACTERISTICS

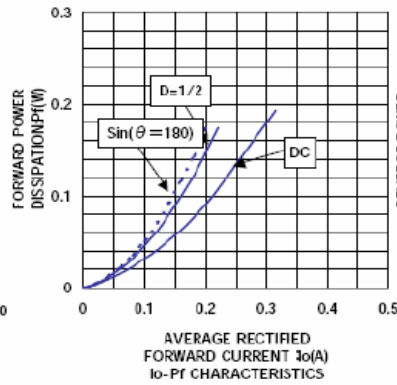

AVERAGE RECTIFIED FORWARD CURRENT I_o (A)
 I_o - P_f CHARACTERISTICS

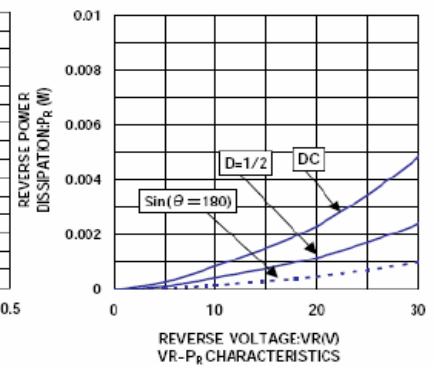

REVERSE VOLTAGE- $V_{R(M)}$
 V_R - P_r CHARACTERISTICS

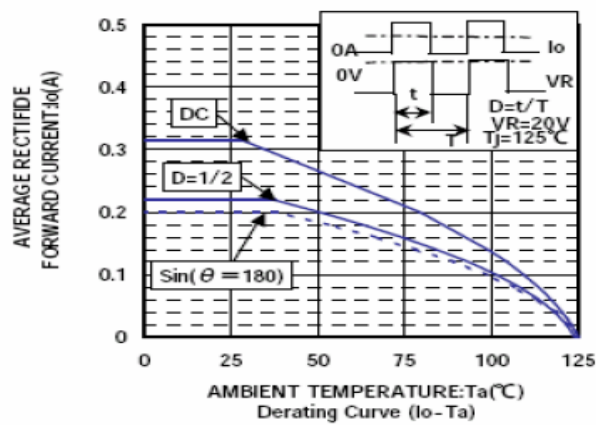

AMBIENT TEMPERATURE: T_a (°C)
Derating Curve (I_o - T_a)

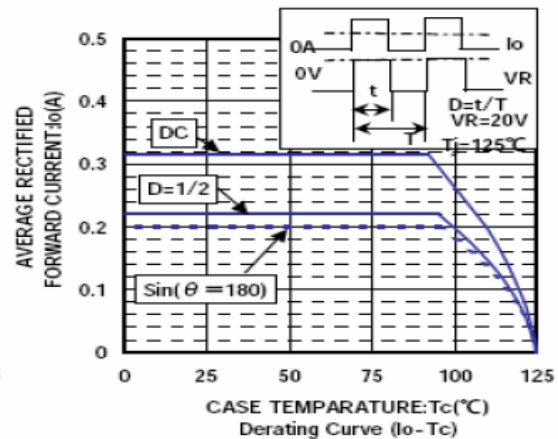

CASE TEMPERATURE: T_c (°C)
Derating Curve (I_o - T_c)

PACKAGE OUTLINE

Plastic surface mounted package

SOD-523

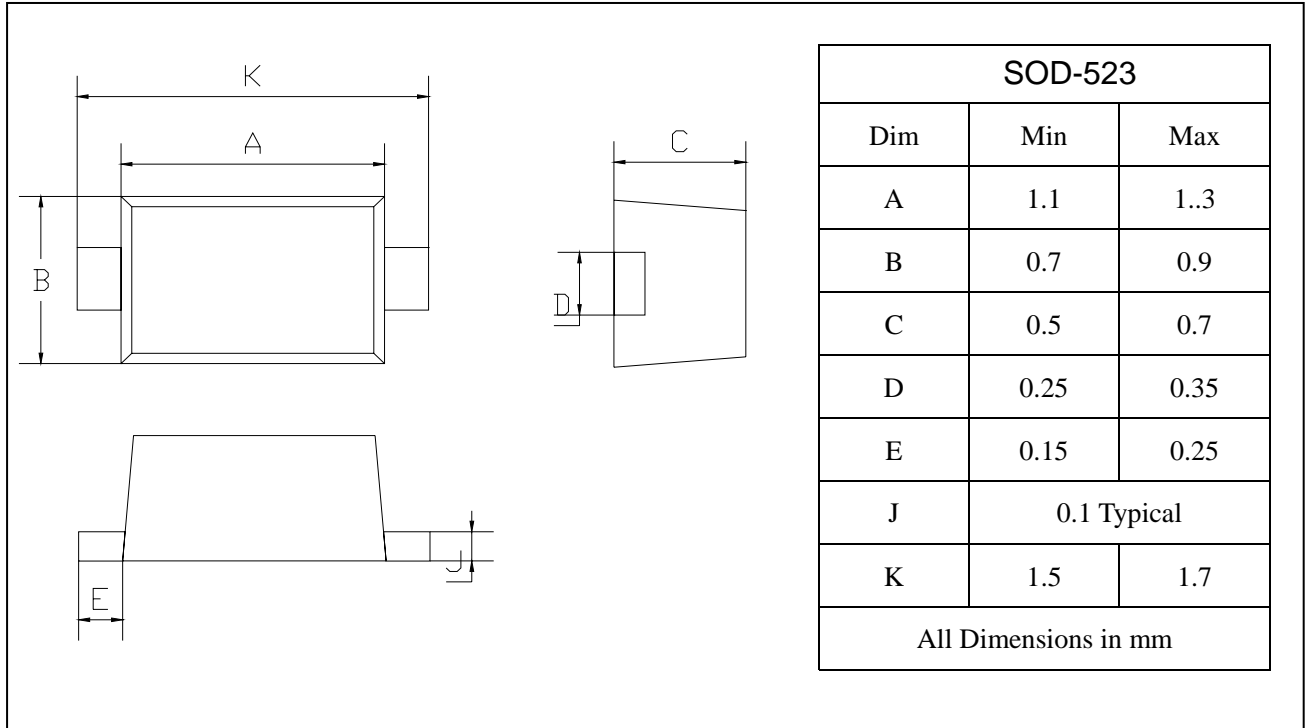

SOLDERING FOOTPRINT

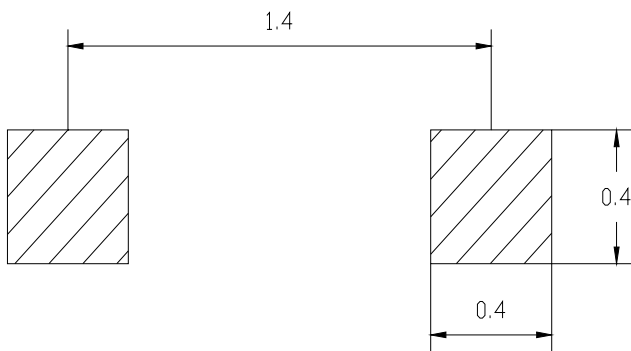

Unit: mm

PACKAGE INFORMATION

| Device | Package | Shipping |
|-----------|---------|----------------|
| RB520S-30 | SOD-523 | 3000/Tape&Reel |

X-ON Electronics

Largest Supplier of Electrical and Electronic Components

Click to view similar products for [Schottky Diodes & Rectifiers](#) category:

Click to view products by [JSMSEMI](#) manufacturer:

Other Similar products are found below :

[MA4E2039](#) [MA4E2508M-1112](#) [MBR0530L-TP](#) [MBR10100CT-BP](#) [MBR1545CT](#) [MMBD301M3T5G](#) [RB160M-50TR](#)
[BAS16E6433HTMA1](#) [BAS 3010S-02LRH E6327](#) [BAT 54-02LRH E6327](#) [IDL02G65C5XUMA1](#) [NSR05F40QNXT5G](#) [NSVR05F40NXT5G](#)
[NTE555](#) [JANS1N6640](#) [SB07-03C-TB-H](#) [SB1003M3-TL-W](#) [SBM30-03-TR-E](#) [SBS818-TL-E](#) [SK310-T](#) [SK33A-TP](#) [SK34B-TP](#) [SS3003CH-](#)
[TL-E](#) [PDS3100Q-7](#) [GA01SHT18](#) [CRS10I30A\(TE85L,QM](#) [MA4E2501L-1290](#) [MBRA140TRPBF](#) [MBRB30H30CT-1G](#) [JANTX1N5712-1](#)
[SB007-03C-TB-E](#) [SK33B-TP](#) [SK35A-TP](#) [SK38B-LTP](#) [NTE505](#) [NTSB30U100CT-1G](#) [VS-6CWQ10FNHM3](#) [CRG04\(T5L,TEMQ\)](#)
[ACDBA1100LR-HF](#) [ACDBA1200-HF](#) [ACDBA240-HF](#) [ACDBA3100-HF](#) [CDBQC0530L-HF](#) [ACDBA260LR-HF](#) [ACDBA1100-HF](#)
[MA4E2502L-1246](#) [10BQ015-M3/5BT](#) [10BQ060-M3/5BT](#) [NRVB130LSFT1G](#) [CRS08TE85LQM](#)