

FEATURES

- High current gain bandwidth product.
- power dissipation.($P_C=200\text{mW}$)

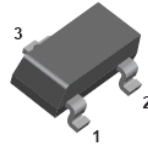

SOT-23

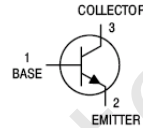

APPLICATIONS

- NPN epitaxial silicon transistor.

ORDERING INFORMATION

Type No.	Marking	Package Code
S9018	J8	SOT-23

MAXIMUM RATING @ $T_a=25^\circ\text{C}$ unless otherwise specified

Symbol	Parameter	Value	Units
V_{CB0}	Collector-Base Voltage	25	V
V_{CEO}	Collector-Emitter Voltage	18	V
V_{EBO}	Emitter-Base Voltage	4	V
I_C	Collector Current -Continuous	50	mA
P_C	Collector Dissipation	200	mW
T_j, T_{stg}	Junction and Storage Temperature	-55~150	$^\circ\text{C}$

ELECTRICAL CHARACTERISTICS @ $T_a=25^\circ\text{C}$ unless otherwise specified

Parameter	Symbol	Test conditions	MIN	TYP	MAX	UNIT
Collector-base breakdown voltage	$V_{(BR)CB0}$	$I_C=100\mu\text{A}, I_E=0$	25			V
Collector-emitter breakdown voltage	$V_{(BR)CEO}$	$I_C=0.1\text{mA}, I_B=0$	18			V
Emitter-base breakdown voltage	$V_{(BR)EBO}$	$I_E=-100\mu\text{A}, I_C=0$	4			V
Collector cut-off current	I_{CB0}	$V_{CB}=20\text{V}, I_E=0$			0.1	μA
Collector cut-off current	I_{CEO}	$V_{CE}=15\text{V}, I_B=0$			0.1	μA
Emitter cut-off current	I_{EBO}	$V_{EB}=3\text{V}, I_C=0$			0.1	μA
DC current gain	h_{FE}	$V_{CE}=5\text{V}, I_C=1\text{mA}$	70		190	
Collector-emitter saturation voltage	$V_{CE(sat)}$	$I_C=10\text{mA}, I_B=1\text{mA}$			0.5	V
Base-emitter saturation voltage	$V_{BE(sat)}$	$I_C=10\text{mA}, I_B=1\text{mA}$			1.4	V
Transition frequency	f_T	$V_{CE}=5\text{V}, I_C=5\text{mA}$ $f=400\text{MHz}$	600			MHz

TYPICAL CHARACTERISTICS @ Ta=25°C unless otherwise specified

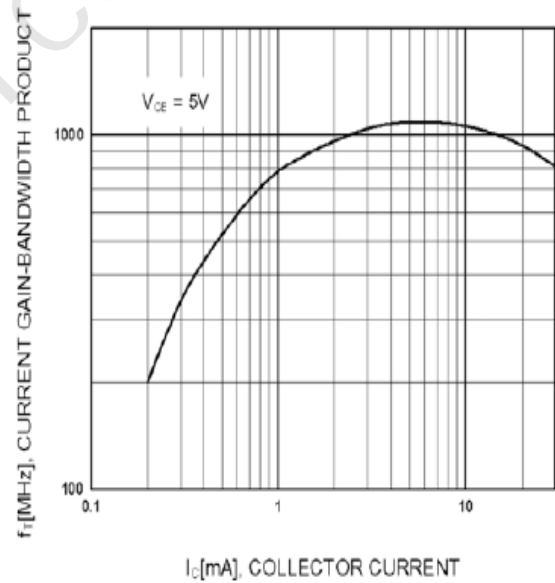
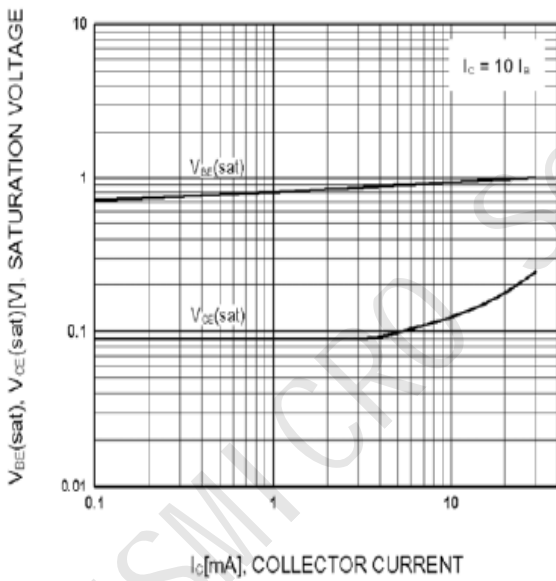
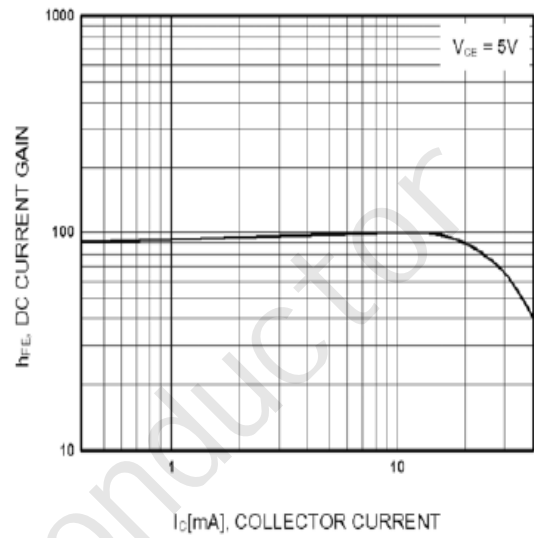
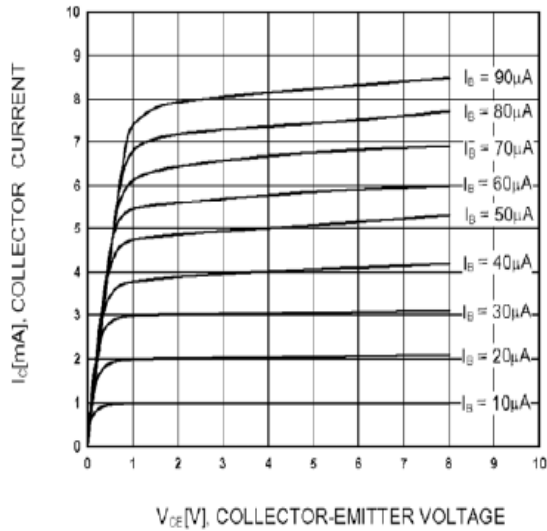

PACKAGE OUTLINE

Plastic surface mounted package

SOT-23

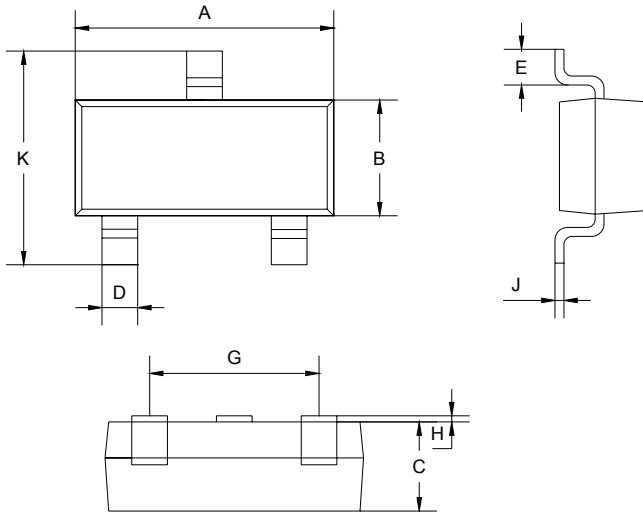

SOT-23		
Dim	Min	Max
A	2.85	2.95
B	1.25	1.35
C	1.0Typical	
D	0.37	0.43
E	0.35	0.48
G	1.85	1.95
H	0.02	0.1
J	0.1Typical	
K	2.35	2.45
All Dimensions in mm		

SOLDERING FOOTPRINT

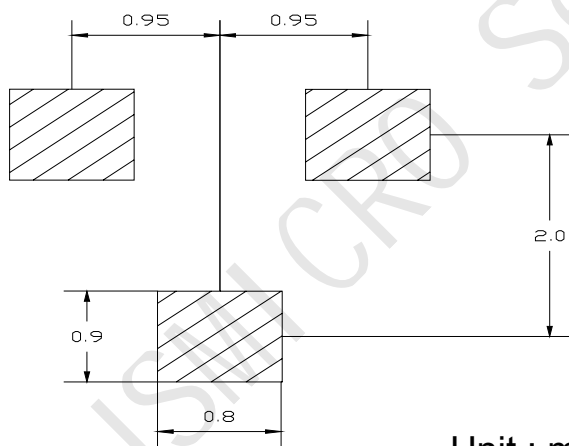

Unit : mm

PACKAGE INFORMATION

Device	Package	Shipping
S9018	SOT-23	3000/Tape&Reel

X-ON Electronics

Largest Supplier of Electrical and Electronic Components

Click to view similar products for [Bipolar Transistors - BJT category](#):

Click to view products by [JSMSEMI manufacturer](#):

Other Similar products are found below :

[619691C](#) [MCH4017-TL-H](#) [MMBT-2369-TR](#) [BC546/116](#) [BC557/116](#) [BSW67A](#) [NJVMJD148T4G](#) [NTE123AP-10](#) [NTE153MCP](#) [NTE16](#)
[NTE195A](#) [NTE92](#) [C4460](#) [2N4401-A](#) [2N6728](#) [2SA1419T-TD-H](#) [2SA2126-E](#) [2SB1204S-TL-E](#) [2SC2712S-GR,LF](#) [2SC5488A-TL-H](#)
[2SD2150T100R](#) [SP000011176](#) [2N2907A](#) [2N3904-NS](#) [2N5769](#) [2SC2412KT146S](#) [2SD1816S-TL-E](#) [CPH6501-TL-E](#) [MCH4021-TL-E](#)
[MJE340](#) [US6T6TR](#) [NJL0281DG](#) [732314D](#) [CPH3121-TL-E](#) [CPH6021-TL-H](#) [873787E](#) [IMZ2AT108](#) [UMX21NTR](#) [MCH6102-TL-E](#) [FP204-](#)
[TL-E](#) [NJL0302DG](#) [2N3583](#) [2SA2014-TD-E](#) [2SC2812-5-TB-E](#) [30A02MH-TL-E](#) [NSV40301MZ4T1G](#) [NTE13](#) [NTE26](#) [NTE282](#) [NTE323](#)