

## FEATURE

- ◆ -20V/-4.3A,  $R_{DS(ON)}=30m\Omega$  (typ.)@ $V_{GS}=-4.5V$
- ◆ -20V/-3.5A,  $R_{DS(ON)}=40m\Omega$  (typ.)@ $V_{GS}=-2.5V$
- ◆ -20V/-2.0A,  $R_{DS(ON)}=56m\Omega$  (typ.)@ $V_{GS}=-1.8V$
- ◆ -20V/-1.0A,  $R_{DS(ON)}=85m\Omega$  (typ.)@ $V_{GS}=-1.5V$
- ◆ Super high design for extremely low  $R_{DS(ON)}$
- ◆ Exceptional on-resistance and Maximum DC current capability
- ◆ Full RoHS compliance
- ◆ SOT23-3 package design

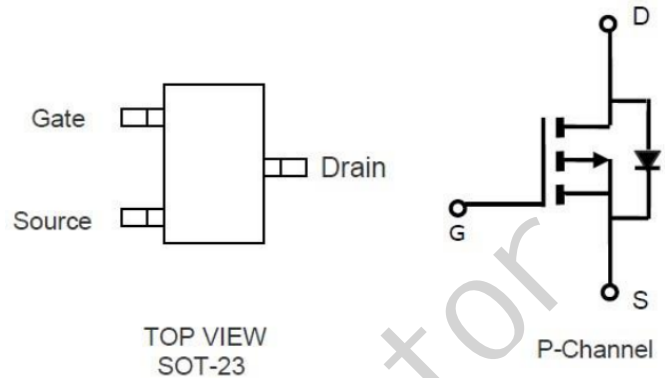

## DESCRIPTION

The 3415 is the P-Channel logic enhancement mode power field effect transistor is produced using high cell density advanced trench technology.. This high density process is especially tailored to minimize on-state resistance. These devices are particularly suited for low voltage application, and low in-line power loss are needed in a very small outline surface mount package.

## APPLICATIONS

- ◆ Power Management
- ◆ Portable Equipment
- ◆ DC/DC Converter
- ◆ Load Switch
- ◆ DSC
- ◆ LCD Display inverter

## ABSOLUTE MAXIMUM RATINGS ( $T_A = 25^\circ C$ Unless otherwise noted )

Symbol	Parameter		Typical	Unit
$V_{DSS}$	Drain-Source Voltage		-20	V
$V_{GSS}$	Gate-Source Voltage		$\pm 10$	V
$I_D$	Continuous Drain Current ( $T_C=25^\circ C$ )	$V_{GS}=-10V$	-4.2	A
	Continuous Drain Current ( $T_C=70^\circ C$ )		-3.5	A
$I_{DM}$	Pulsed Drain Current		-20	A
$P_D$	Power Dissipation	$T_A=25^\circ C$	1.5	W
		$T_A=70^\circ C$	0.9	
$T_J$	Operation Junction Temperature		150	$^\circ C$
$T_{STG}$	Storage Temperature Range		-55~+150	$^\circ C$
$R_{\theta JA}$	Thermal Resistance Junction to Ambient		120	$^\circ C/W$

**Note: Absolute maximum ratings are those values beyond which the device could be permanently damaged. Absolute maximum ratings are stress rating only and functional device operation is not implied**

**ELECTRICAL CHARACTERISTICS** ( $T_A=25^\circ\text{C}$  Unless otherwise noted)

Symbol	Parameter	Condition	Min	Typ	Max	Unit
<b>Static Parameters</b>						
$V_{(BR)DSS}$	Drain-Source Breakdown Voltage	$V_{GS}=0V, I_D=-250\mu A$	-20			V
$V_{GS(th)}$	Gate Threshold Voltage	$V_{DS}=V_{GS}, I_D=-250\mu A$	-0.3		-1.0	V
$I_{GSS}$	Gate Leakage Current	$V_{DS}=0V, V_{GS}=\pm 10V$			$\pm 100$	nA
$I_{DSS}$	Zero Gate Voltage Drain Current	$V_{DS}=-20V, V_{GS}=0$			-1	uA
		$V_{DS}=-20V, V_{GS}=0$ $T_J=55^\circ\text{C}$			-5	
$R_{DS(ON)}$	Drain-Source On-Resistance	$V_{GS}=-4.5V, I_D=-4.0A$		30	40	m $\Omega$
		$V_{GS}=-2.5V, I_D=-4.0A$		40	60	
		$V_{GS}=-1.8V, I_D=-2.0A$		56	78	
		$V_{GS}=-1.5V, I_D=-1.0A$		85	110	
Gfs	Forward Transconductance	$V_{DS}=-5V, I_D=-4.0A$		22		S
<b>Source-Drain Diode</b>						
$V_{SD}$	Diode Forward Voltage	$I_S=-1.0A, V_{GS}=0V$		-0.67	-1.2	V
<b>Dynamic Parameters</b>						
$Q_g$	Total Gate Charge	$V_{DS}=-10V$		11.1		nC
$Q_{gs}$	Gate-Source Charge	$V_{GS}=-4.5V$		3.1		
$Q_{gd}$	Gate-Drain Charge	$I_D=-4.0A$		2.4		
$C_{iss}$	Input Capacitance	$V_{DS}=-10V$		989		pF
$C_{oss}$	Output Capacitance	$V_{GS}=0V$		167		
$C_{riss}$	Reverse Transfer Capacitance	$f=1\text{MHz}$		75.5		
$T_{d(on)}$	Turn-On Time	$V_{DS}=-10V$		712		nS
$T_r$		$I_D=-3.7A$		1386		
$T_{d(off)}$	Turn-Off Time	$V_{GEN}=-4.5V$		9.1		
$T_f$		$R_G=1\Omega$		4		

Note: 1. Pulse test: pulse width $\leq 300\mu\text{s}$ , duty cycle $\leq 2\%$

2. Static parameters are based on package level with recommended wire bonding

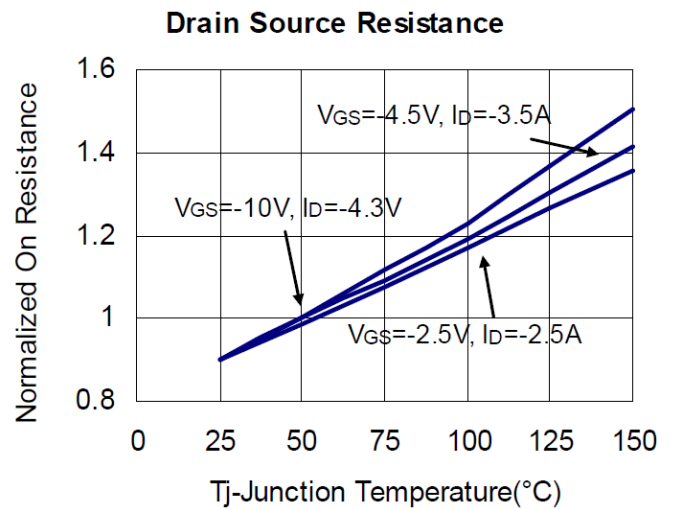
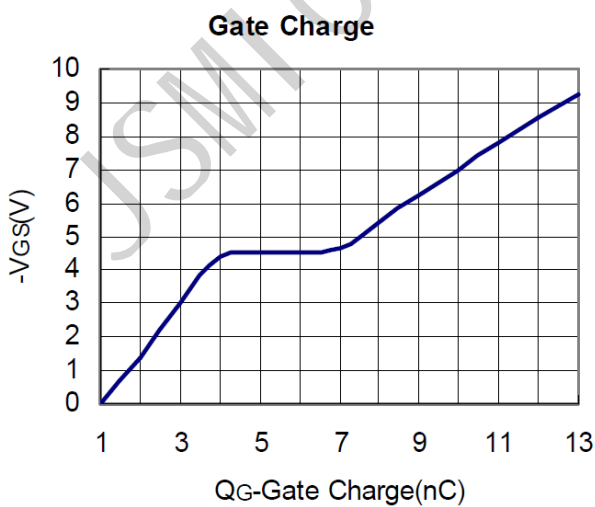
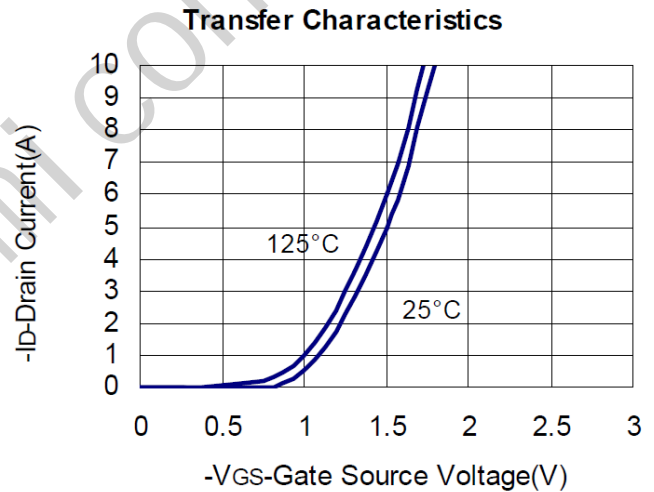
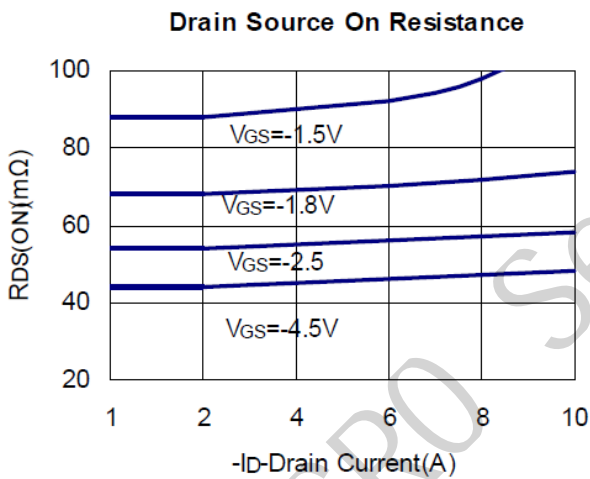
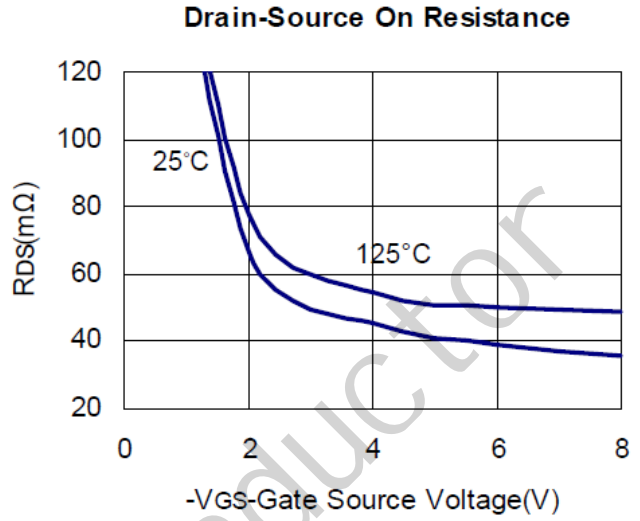
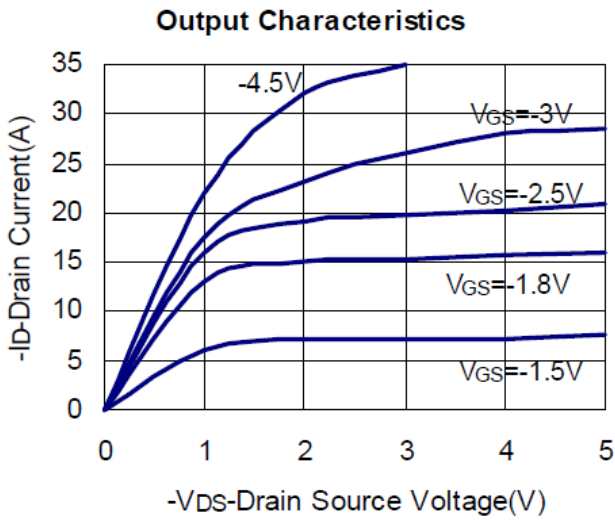
**TYPICAL CHARACTERISTICS (25°C Unless Note)**

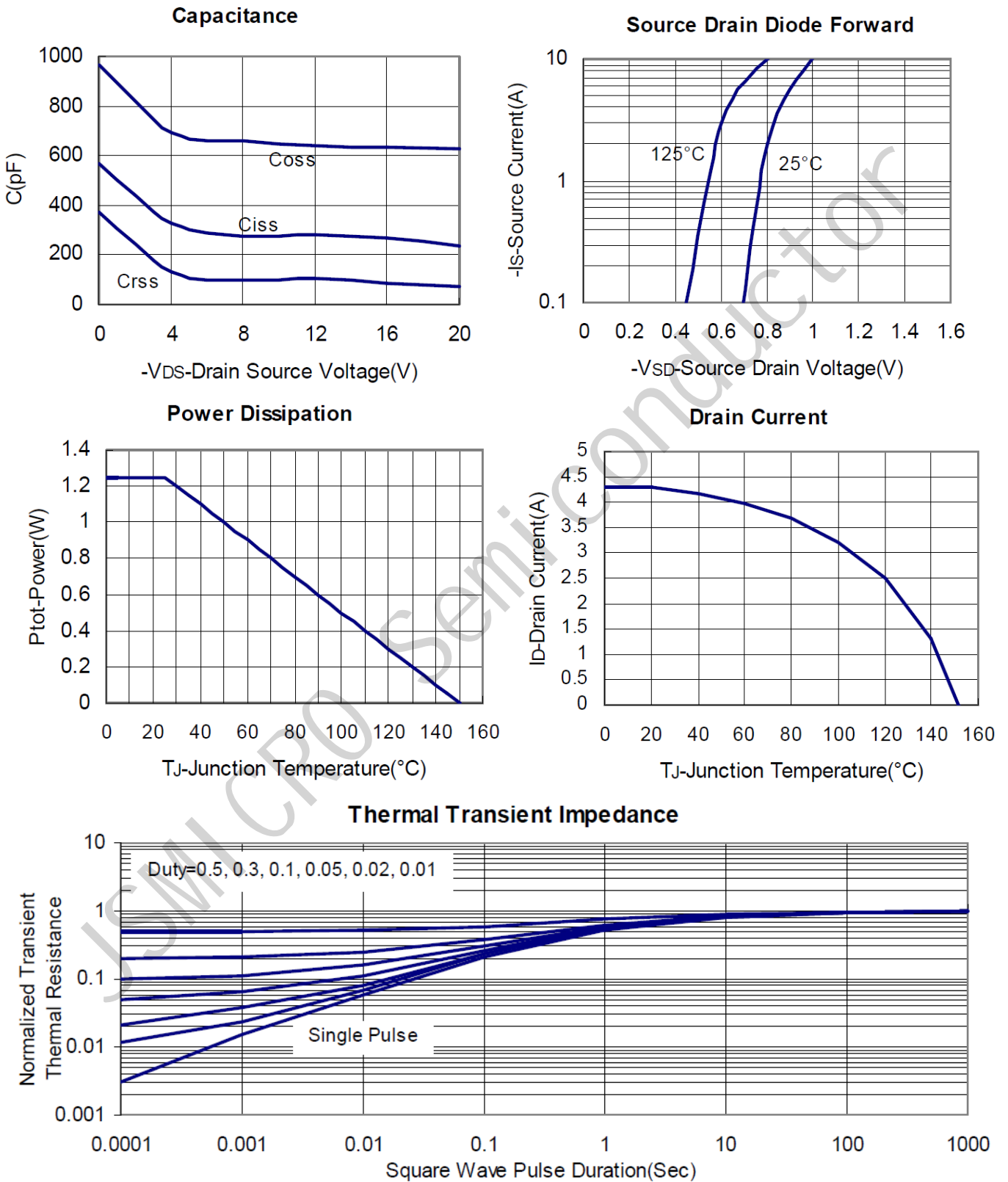
**■ TYPICAL CHARACTERISTICS (continuous)**

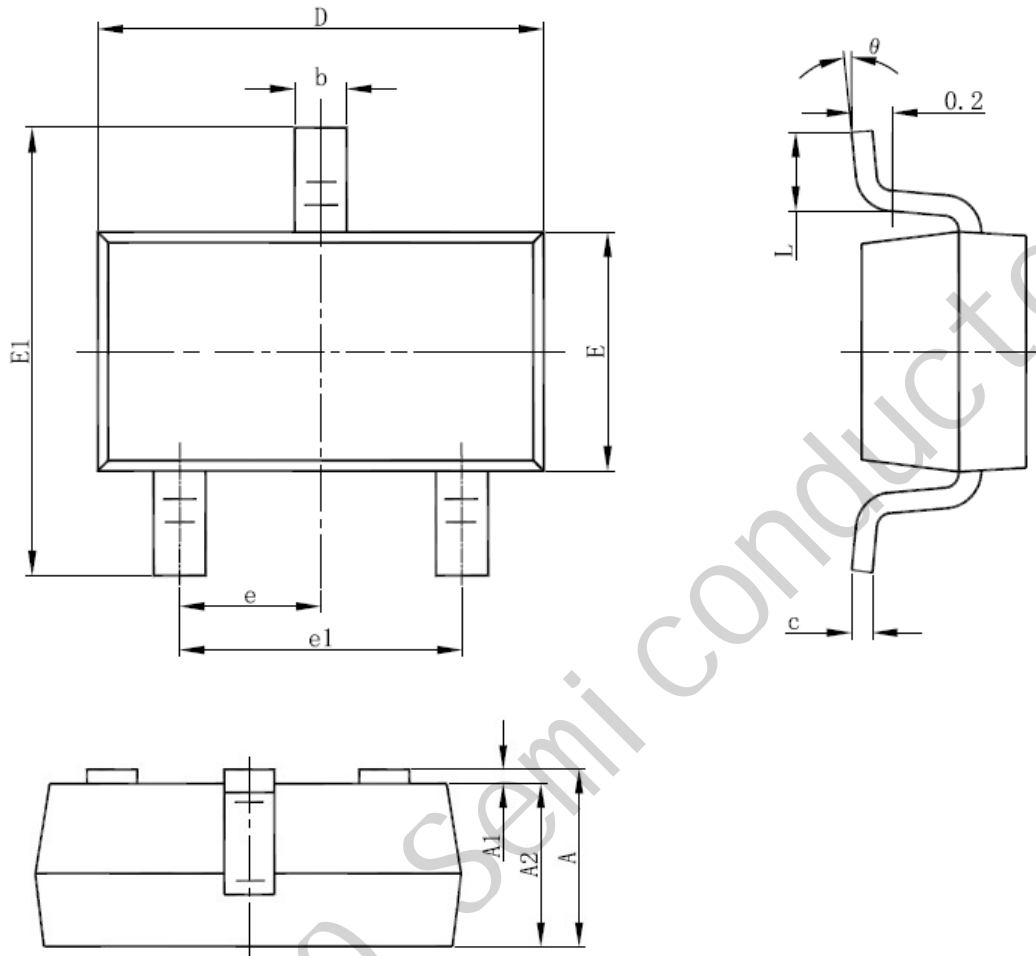
**■ SOT23 PACKAGE OUTLINE DIMENSIONS**

Symbol	Dimensions In Millimeters		Dimensions In Inches	
	Min	Max	Min	Max
A	1.050	1.250	0.041	0.049
A1	0.000	0.100	0.000	0.004
A2	1.050	1.150	0.041	0.045
b	0.300	0.500	0.012	0.020
c	0.100	0.200	0.004	0.008
D	2.820	3.020	0.111	0.119
E	1.500	1.700	0.059	0.067
E1	2.650	2.950	0.104	0.116
e	0.950(BSC)		0.037(BSC)	
e1	1.800	2.000	0.071	0.079
L	0.300	0.600	0.012	0.024
$\theta$	0°	8°	0°	8°

## X-ON Electronics

Largest Supplier of Electrical and Electronic Components

*Click to view similar products for [MOSFET](#) category:*

*Click to view products by [JSMSEMI](#) manufacturer:*

Other Similar products are found below :

[IRFD120](#) [JANTX2N5237](#) [2SK2267\(Q\)](#) [BUK455-60A/B](#) [TK100A10N1,S4X\(S](#) [MIC4420CM-TR](#) [VN1206L](#) [NDP4060](#) [SI4482DY](#)  
[IRS2092STRPBF-EL](#) [IPS70R2K0CEAKMA1](#) [TK31J60W5,S1VQ\(O](#) [TK31J60W,S1VQ\(O](#) [TK16J60W,S1VQ\(O](#) [2SK2614\(TE16L1,Q\)](#)  
[DMN1017UCP3-7](#) [EFC2J004NUZTDG](#) [P85W28HP2F-7071](#) [DMN1053UCP4-7](#) [NTE2384](#) [DMC2700UDMQ-7](#) [DMN2080UCB4-7](#)  
[DMN61D9UWQ-13](#) [US6M2GTR](#) [DMN31D5UDJ-7](#) [DMP22D4UFO-7B](#) [IPS60R3K4CEAKMA1](#) [DMN1006UCA6-7](#) [DMN16M9UCA6-7](#)  
[STF5N65M6](#) [IRF40H233XTMA1](#) [STU5N65M6](#) [DMN6022SSD-13](#) [DMN13M9UCA6-7](#) [DMTH10H4M6SPS-13](#) [IPS60R360PFD7SAKMA1](#)  
[DMN2990UFB-7B](#) [SSM3K35CT,L3F](#) [IPLK60R1K0PFD7ATMA1](#) [2N7002W-G](#) [MCAC30N06Y-TP](#) [IPWS65R035CFD7AXKSA1](#)  
[MCQ7328-TP](#) [SSM3J143TU,LXHF](#) [DMN12M3UCA6-7](#) [PJMF280N65E1\\_T0\\_00201](#) [PJMF380N65E1\\_T0\\_00201](#)  
[PJMF280N60E1\\_T0\\_00201](#) [PJMF600N65E1\\_T0\\_00201](#) [PJMF900N65E1\\_T0\\_00201](#)