

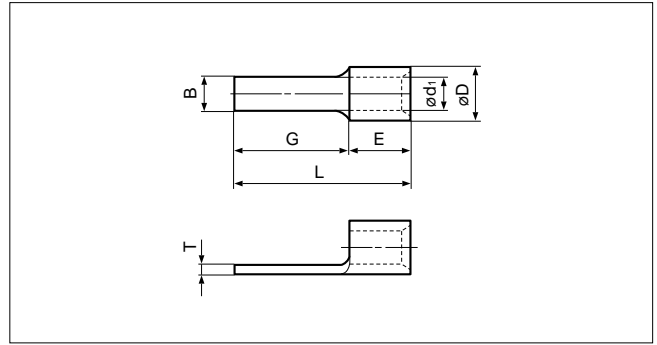



Solderless terminals

BLADE Non-insulated



Certificate No.:  E42024

Applicable Wire AWG# (mm ²)	Part No.	Standard	Dimensions mm (in.)							Tool No.				Qty/box
			B	L	G	E	øD	ød1	T	YHT-2210	YA-1	YA-2	YA-4	
22 to 16 (0.25 to 1.65)	1.25-1AF		2.8 (.110)	13.3 (.524)	9.0 (.354)	4.3 (.169)	3.4 (.134)	1.7 (.067)	0.8 (.031)	0	0	0	0	1,000
	1.25-2AF		3.4 (.134)	15.0 (.591)	10.2 (.402)	4.8 (.189)								
	1.25-3AF		1.0 (.039)	14.0 (.551)	9.8 (.386)	4.2 (.165)								
	1.25-AF2.3A		2.3 (.091)	23.0 (.906)	18.2 (.717)	4.8 (.189)								
	1.25-AF2.3B		2.3 (.091)	15.0 (.591)	10.2 (.402)	4.8 (.189)								
	1.25-AF3A-S		3.0 (.118)	17.3 (.681)	12.5 (.492)	4.8 (.189)								
	1.25-BL		3.0 (.118)	15.9 (.626)	11.1 (.437)	4.8 (.189)								
1.25-BL2	3.0 (.118)	19.3 (.760)	14.5 (.571)	4.8 (.189)										
16 to 14 (1.04 to 2.63)	2-1AF		2.8 (.110)	13.3 (.524)	9.0 (.354)	4.3 (.169)	4.1 (.161)	2.3 (.091)	0.8 (.031)	0	0	0	0	1,000
	2-2AF G-16		2.8 (.110)	20.8 (.819)	16.0 (.630)	4.8 (.189)								
	2-AFW		4.6 (.181)	23.0 (.906)	18.2 (.717)	4.8 (.189)								
	2-AF2.3A		2.3 (.091)	23.0 (.906)	18.2 (.717)	4.8 (.189)								
	2-AF3A-S		3.0 (.118)	17.3 (.681)	12.5 (.492)	4.8 (.189)								
12 to 10 (2.63 to 6.64)	5.5-1AF		2.8 (.110)	16.2 (.638)	10.0 (.394)	6.2 (.244)	5.6 (.220)	3.4 (.134)	1.0 (.039)	0	0	0	0	500
	5.5-2AF	4.0 (.157)	25.4(1.000)	18.6 (.732)	6.8 (.268)									
	5.5-AFW	4.5 (.177)	25.4(1.000)	18.6 (.732)	6.8 (.268)									
	5.5-AF4A-S	4.0 (.157)	20.8 (.819)	14.0 (.551)	6.8 (.268)									

- Note: 1) Terminals with part number suffix "-S" have serrations on the blade.
 2) The part numbers indicated in the above table are for products with a brazed seam.
 When ordering products with a butted seam, add the prefix "WS" to the part number (ex. 2-1AF → **WS2-1AF**).
 3) Delivery lead times may vary depending on the product. Contact JST for details.

Solderless terminals

BLADE Vinyl-insulated

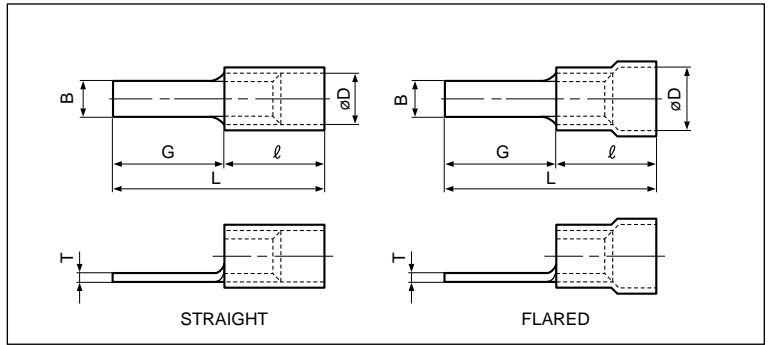

Certificate No.: E42024

Applicable Wire AWG#(mm ²)	Part No.		Standard	Dimensions mm (in.)						Color	Tool No.						Qty/box	
	Straight	Flared		B	L	G	ℓ	ø D			T	YNT-2216	YNT-1614	YNT-1210S	YA-1	YA-2		YA-4
								Str.	Fl.									
22 to 16 (0.25 to 1.65)	V1.25-1AF	FV1.25-1AF		2.8 (.110)	18.0 (.709)	9.0 (.354)	9.0 (.354)	3.2 (.126)	4.0 (.157)	0.8 (.031)	Red	o	o	o	o	o	1,000	
	V1.25-2AF	FV1.25-2AF		3.4 (.134)	19.2 (.756)	10.2 (.402)												
	-	FV1.25-AF2.3A		2.3 (.091)	27.2(1.071)	18.2 (.717)												
	-	FV1.25-AF2.3B		2.3 (.091)	19.2 (.756)	10.2 (.402)												
	V1.25-AF3A-S	FV1.25-AF3A-S		3.0 (.118)	21.5 (.846)	12.5 (.492)												
	-	FV1.25-BL		3.0 (.118)	20.1 (.791)	11.1 (.437)												
16 to 14 (1.04 to 2.63)	V2-1AF	FV2-1AF		2.8 (.110)	18.0 (.709)	9.0 (.354)	9.0 (.354)	3.9 (.154)	4.5 (.177)	0.8 (.031)	Blue	o	o	o	o	o	1,000	
	V2-AFW	FV2-AFW		4.6 (.181)	27.2(1.071)	18.2 (.717)												
	-	FV2-AF2.3A		2.3 (.091)	27.2(1.071)	18.2 (.717)												
	-	FV2-AF3A-S		3.0 (.118)	21.5 (.846)	12.5 (.492)												
12 to 10 (2.63 to 6.64)	V5.5-1AF	FV5.5-1AF		2.8 (.110)	23.5 (.925)	10.0 (.394)	13.5 (.531)	5.4 (.213)	6.8 (.268)	1.0 (.039)	Yellow	o	o	o	o	500		
	V5.5-AFW	FV5.5-AFW		4.5 (.177)	32.1(1.264)	18.6 (.732)												
	V5.5-AF4A-S	FV5.5-AF4A-S		4.0 (.157)	27.5(1.083)	14.0 (.551)												



- Note: 1) Terminals with part number suffix "-S" have serrations on the blade.
 2) The part numbers indicated in the above table are for products with a brazed seam. When ordering products with a butted seam, add the prefix "WS" to the part number (ex. V2-1AF → **VWS2-1AF**).
 3) *The crimping will be more secure if the total cross-sectional area of the wire is at least 0.5 mm².
 Examples: If the cross-sectional area of the wire is 0.3 mm², fold the wire in two when crimping the terminal.
 If the cross-sectional area of the wire is 0.5 mm², crimp the terminal onto the wire as it is.
 4) Delivery lead times may vary depending on the product. Contact JST for details.

Solderless terminals

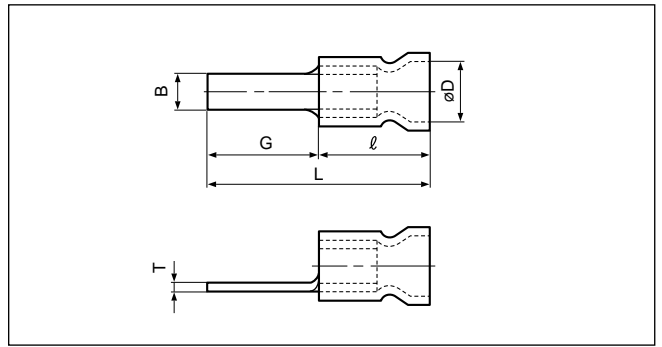
BLADE Vinyl-insulated (funnel-entry)



Certificate No.:  E42024

Applicable Wire AWG# (mm ²)	Part No.	Standard	Dimensions mm (in.)						Color	Tool No.			Qty/box			
			B	L	G	ℓ	øD	T		YNT-2216	YNT-1614	YNT-1210S		YA-1	YA-2	YA-4
22 to 16 (0.25 to 1.65)	FVX1.25-AF2.3B		2.3 (.091)	21.0 (.827)	10.2 (.402)	10.8 (.425)	4.0 (.157)	0.8 (.031)	Red	○			○	○	○	1,000
	FVX1.25-BL		3.0 (.118)	21.9 (.862)	11.1 (.437)											
16 to 14 (1.04 to 2.63)	FVX2-AFW		4.6 (.181)	29.0(1.142)	18.2 (.717)	10.8 (.425)	4.6 (.181)	0.8 (.031)	Blue		○		○	○	○	1,000
	FVX2-AF3A-S		3.0 (.118)	23.3 (.917)	12.5 (.492)											



- Note: 1) Terminals with part number suffix "-S" have serrations on the blade.
 2) The part numbers indicated in the above table are for products with a brazed seam.
 When ordering products with a butted seam, add the prefix "WS" to the part number (ex. FVX1.25-AF3A-S → **FVXWS1.25-AF3A-S**).
 3) *The crimping will be more secure if the total cross-sectional area of the wire is at least 0.5 mm².
 Examples: If the cross-sectional area of the wire is 0.3 mm², fold the wire in two when crimping the terminal.
 If the cross-sectional area of the wire is 0.5 mm², crimp the terminal onto the wire as it is.
 4) Delivery lead times may vary depending on the product. Contact JST for details.

Solderless terminals

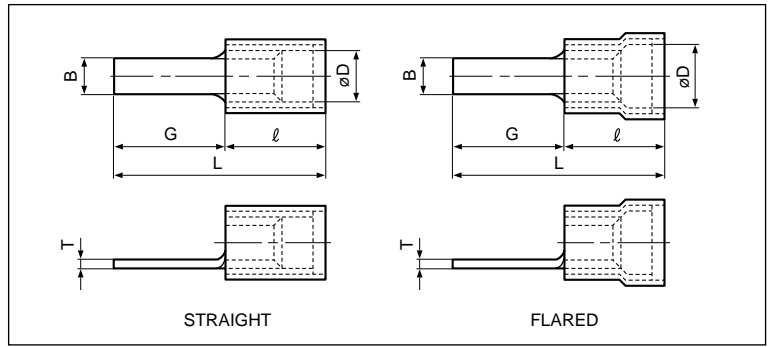
BLADE vinyl-insulated with copper sleeve



Certificate No.:  E42024

Applicable Wire AWG#(mm ²)	Part No.		Standard	Dimensions mm (in.)							Color	Tool No.				Qty/box		
	Straight	Flared		B	L	G	ℓ	ø D		T		YNT-2216	YNT-1614	YNT-1210S	YA-1		YA-2	YA-4
								Str.	Fld.									
22 to 16 (0.25 to 1.65)	VD1.25-1AF	FVD1.25-1AF		2.8 (.110)	18.6 (.732)	9.0 (.354)	9.6 (.378)	3.5 (.138)	4.0 (.157)	0.8 (.031)	Red	o	o	o	o	1,000		
	VD1.25-2AF	-		3.4 (.134)	19.8 (.780)	10.2 (.402)												
	VD1.25-3AF	FVD1.25-3AF		1.0 (.039)	19.4 (.764)	9.8 (.386)												
	VD1.25-AF2.3B	FVD1.25-AF2.3B		2.3 (.091)	19.8 (.780)	10.2 (.402)												
	VD1.25-AF3A-S	FVD1.25-AF3A-S		3.0 (.118)	22.1 (.870)	12.5 (.492)												
	VD1.25-BL	-		3.0 (.118)	20.7 (.815)	11.1 (.437)												
16 to 14 (1.04 to 2.63)	VD2-1AF	FVD2-1AF		2.8 (.110)	18.1 (.713)	9.0 (.354)	9.6 (.378)	4.1 (.161)	4.7 (.185)	0.8 (.031)	Blue	o	o	o	o	1,000		
	VD2-2AF G-16	FVD2-2AF G-16		2.8 (.110)	25.6(1.008)	16.0 (.630)												
	VD2-AFW	FVD2-AFW		4.6 (.181)	27.8(1.094)	18.2 (.717)												
	VD2-AF2.3A	FVD2-AF2.3A		2.3 (.091)	27.8(1.094)	18.2 (.717)												
	-	FVD2-AF3A-S		3.0 (.118)	22.1 (.870)	12.5 (.492)												
12 to 10 (2.63 to 6.64)	VD5.5-1AF	-		2.8 (.110)	24.0 (.945)	10.0 (.394)	14.0 (.551)	5.7 (.224)	6.5 (.256)	1.0 (.039)	Yellow	o	o	o	500			
	VD5.5-AFW	-		4.5 (.177)	32.6(1.283)	18.6 (.732)												
	VD5.5-AF4A-S	FVD5.5-AF4A-S		4.0 (.157)	28.0(1.102)	14.0 (.551)												

Note:1) Terminals with part number suffix "-S" have serrations on the blade.

2) The part numbers indicated in the above table are for products with a brazed seam.

When ordering products with a butted seam, add the prefix "WS" to the part number (ex. FVD2-1AF -->FVDWS2-1AF).

3) Delivery lead times may vary depending on the product. Contact JST for details.

Solderless terminals

BLADE Nylon-insulated (straight)

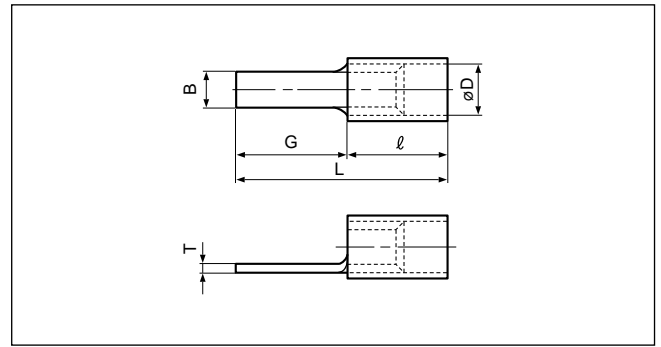

Certificate No.:  E42024

Applicable Wire AWG# (mm ²)	Part No.	Standard	Dimensions mm (in.)						Color	Tool No.				Qty/box
			B	L	G	ℓ	øD	T		YNT-2216	YA-1	YA-2	YA-4	
22 to 16 *(0.25 to 1.65)	N1.25-1AF		2.8 (.110)	18.0 (.709)	9.0 (.354)	9.0 (.354)	3.2 (.126)	0.8 (.031)	Red	○	○	○	○	1,000

Note: 1) *The crimping will be more secure if the total cross-sectional area of the wire is at least 0.5 mm².
 Examples: If the cross-sectional area of the wire is 0.3 mm², fold the wire in two when crimping the terminal.
 If the cross-sectional area of the wire is 0.5 mm², crimp the terminal onto the wire as it is.
 2) Delivery lead times may vary depending on the product. Contact JST for details.