

AUH CONNECTOR

Disconnectable Crimp style connectors

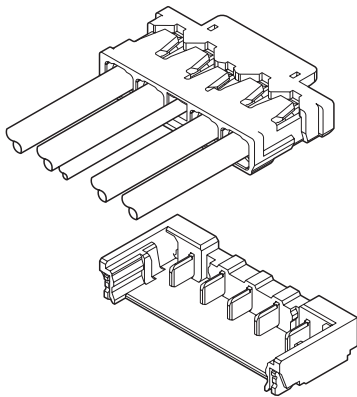

This AUH connector is compact and low profile type, height 1.85 mm and width 5.2 mm, wire-to-board connector. And also 5 A in rating current was realized.

- Space saving
- Top entry but side feed type
- Combination of power supply and signal circuits
 - 3 circuits; Power supply 2 circuits + Signal single circuit
 - 5 circuits; Power supply 4 circuits + Signal single circuit
- Connector for DC power supply (5 A)

Specifications

- Current rating: Signal circuit/ 1 A AC, DC
Power supply circuit/ 5 A AC, DC (AWG #22)
- Voltage rating: 30V AC, DC
- Temperature range: -25°C to +85°C
(including temperature rise in applying electrical current)
- Contact resistance: Initial value/ 10 mΩ max.
After environmental tests/ 20 mΩ max.
- Insulation resistance: 100 MΩ min.
- Withstanding voltage: 200 VAC/ minute
- Applicable wire:
 - Signal circuit; Conductor size/ AWG #30 to #28
Insulation O.D./ 0.5 to 0.63 mm
 - Power supply circuit; Conductor size/AWG #26 to #22
AWG #22; Recommend UL3619 made by Hitachi Cable, Ltd./Furukawa Electric Co., Ltd.
Insulation O.D./0.98 to 1.16 mm
- * Refer to "General Instruction and Notice when using Terminals and Connectors" at the end of this catalog.
- * Contact JST for details.
- * Compliant with RoHS.

Standards

Recognized E60389

<3 circuits>

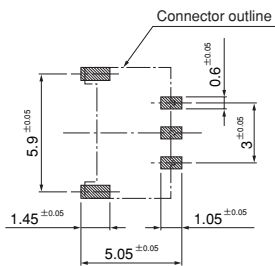

<5 circuits>

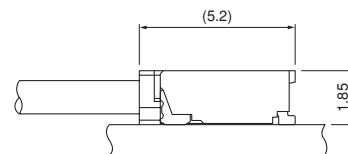
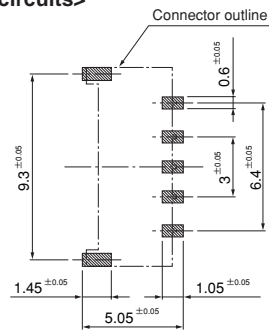

Note: 1. The above figure is the figure viewed from the connector mounting side.

2. Tolerances are non-cumulative: ±0.05 mm for all centers. The dimensions above should serve as a guideline. Contact JST for details.

Table of current rating combinations

<3 circuits>

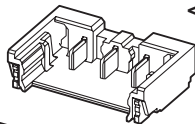

<5 circuits>

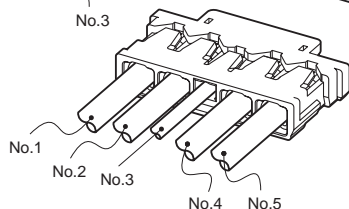
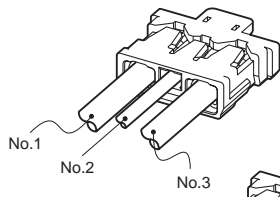
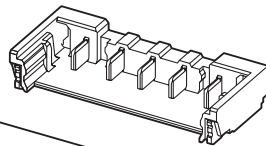

Current unit: A

Circuits	Power supply contact Wire to be used	Circuits No.		
		No.1	No.2	No.3
3	AWG #22	5	1	5
	AWG #24	4	1	4
	AWG #26	3.5	1	3.5

■ : Signal contact AWG#30~#28

Current unit: A

Circuits	Power supply contact Wire to be used	Circuits No.				
		No.1	No.2	No.3	No.4	No.5
5	AWG #22	5	1	1	1	5
		4	4	1	4	4
	AWG #24	4	1	1	1	4
		3.5	3.5	1	3.5	3.5
	AWG #26	3.5	1	1	1	3.5
		3	3	1	3	3

■ : Signal contact AWG#30~#28

AUH CONNECTOR

Contact

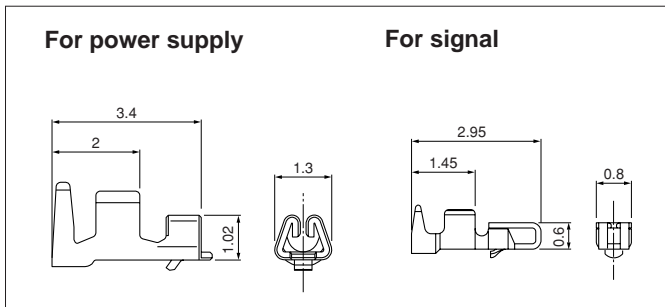

	Model No.	Applicable wire		Insulation O.D. (mm)	Q'ty/reel
		mm ²	AWG#		
Power supply	SAUH-001G-M0.2	0.13~0.33	26~22	0.98~1.16	18,000
Signal	SACH-003G-P0.2	0.05~0.08	30~28	0.5 ~0.63	30,000

Material and Finish

Copper alloy, nickel-undercoated, selective gold-plated

RoHS compliance

Model No.	Crimping machine	Applicable wire		Insulation O.D. (mm)	Applicator		
		mm ²	AWG#		Crimp applicator	Dies	Crimp applicator with dies
SAUH-001G-M0.2	AP-K2N	0.13~0.21	26~24	0.98~1.11	MKS-L-10	MK/SAUH-001-02	APLMK SAUH001-02
		0.33	22	0.98~1.16	MKS-L-10	MK/SAUH-001-02-K	APLMK SAUH001-02-K
SACH-003G-P0.2		0.05~0.08	30~28	0.5~0.63	MKS-L-10-3	MK/SACH-003-02	APLMK SACH003-02
					—	—	—

Housing

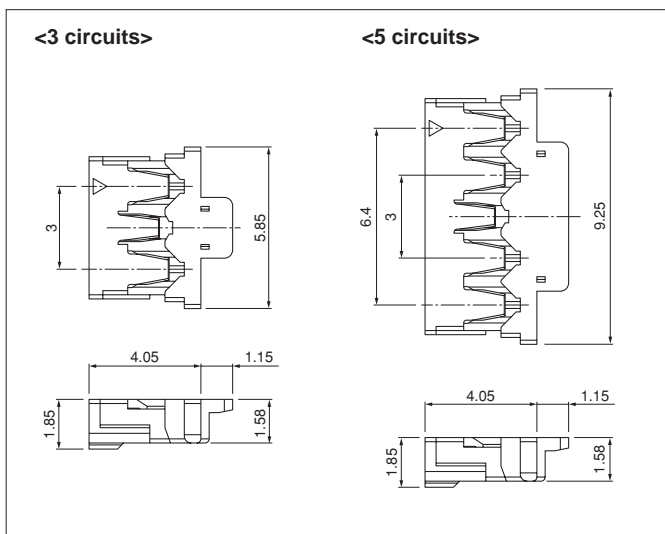

Circuits	Model No.	Q'ty/box
3	AUHR-03V-H	1,000
5	AUHR-05V-H	1,000

Material

PBT, UL94V-0, gray

RoHS compliance

Shrouded header

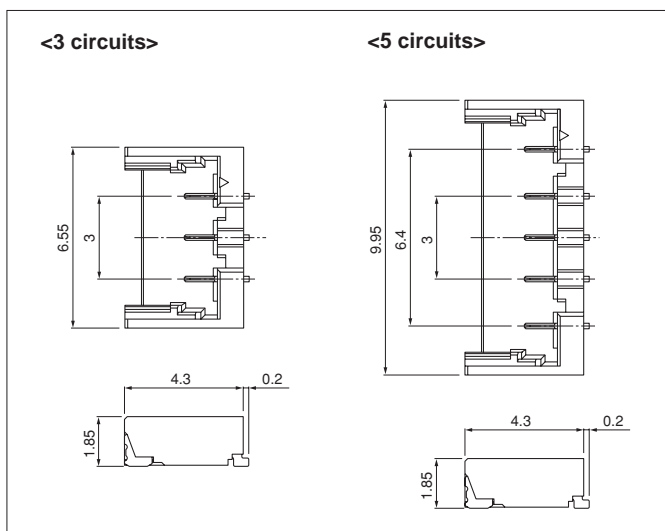

Circuits	Model No.	Q'ty/reel
3	BM03B-AUHKS-GA-TB	5,000
5	BM05B-AUHKS-GA-TB	5,000

Material and Finish

Contact: Copper alloy, nickel-undercoated, gold-plated (nickel-stripe)

Housing: Heat resisting resin, UL94V-0, black

Reinforcing tab: Copper alloy, copper-undercoated, tin-plated (reflow treatment)

RoHS compliance This product displays (LF)(SN) on a label.

X-ON Electronics

Largest Supplier of Electrical and Electronic Components

Click to view similar products for [Headers & Wire Housings](#) category:

Click to view products by [JST](#) manufacturer:

Other Similar products are found below :

[57102-F02-18ULF](#) [58102-G61-06LF](#) [0009485154](#) [009176003701906](#) [0050291907](#) [02.125.8002.8](#) [609-3404](#) [61062-3](#) [622-0430](#) [622-3653LF](#)
[63453-116](#) [636-1030](#) [636-1427](#) [636-3427](#) [636-4007](#) [641938-9](#) [644827-2](#) [65495-038](#) [65692-001LF](#) [65781-018](#) [65781-047](#) [65817-010LF](#)
[65817-015LF](#) [66207-023LF](#) [67016-026LF](#) [67095-007LF](#) [68631-112](#) [68645-018](#) [68648-049](#) [699319-000](#) [70.362.1628.0](#) [70-4210](#) [70-4226B](#)
[70-4853B](#) [707-5020](#) [707-5028](#) [71.350.2428.0](#) [71961-016LF](#) [733-134](#) [754199-000](#) [760-3052](#) [787-8014-00](#) [FCN-367T-T012/H](#) [80.063.4001.1](#)
[800-90-001-10-001000](#) [800-90-010-10-002000](#) [801-43-002-10-013000](#) [801-43-006-10-002000](#) [803-41-018-10-001000](#) [803-43-014-20-](#)
[001000](#)