

PBV CONNECTOR

2.0 mm pitch/Disconnectable Crimp style connectors

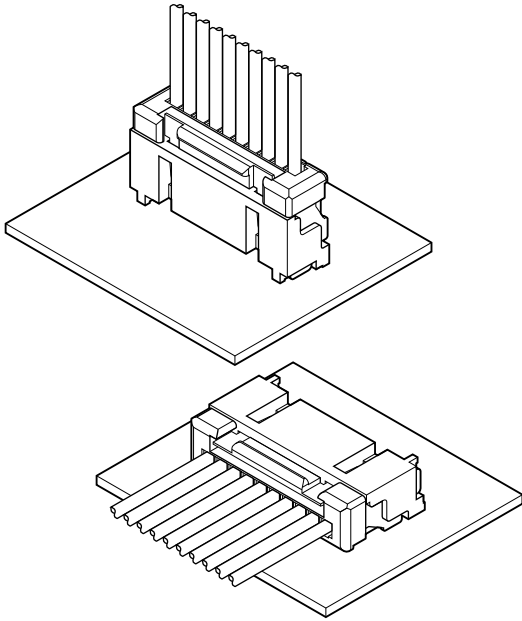

This PBV connector, which is mainly used for connecting PCB of flat television, is a crimping type connector and is designed to have a secure locking structure and a sucking area.

- Secure locking structure
- Sucking area on header
- High reliability contact

Specifications

- Current rating: 3 A AC/DC (AWG #22)
 - Voltage rating: 100 V AC/DC
 - Temperature range: -25°C to +85°C
(including temperature rise in applying electrical current)
 - Contact resistance: Initial value/ 10 mΩ max.
After environmental tests/ 20 mΩ max.
 - Insulation resistance: Initial/ 1,000 MΩ min.
 - Withstanding voltage: 800 VAC/minute
 - Applicable wire: Conductor size/ AWG#28 to #22
Insulation O.D./ 0.9 to 1.5 mm
- * In using the products, refer to "Handling Precautions for Terminals and Connectors" described on our website (Technical documents of Product information page).
- * RoHS2 compliance
- * Dimensional unit: mm
- * Contact JST for details.

Standards

Recognized E 60389

PC board layout and Assembly layout

Top entry type

< 2 circuits >

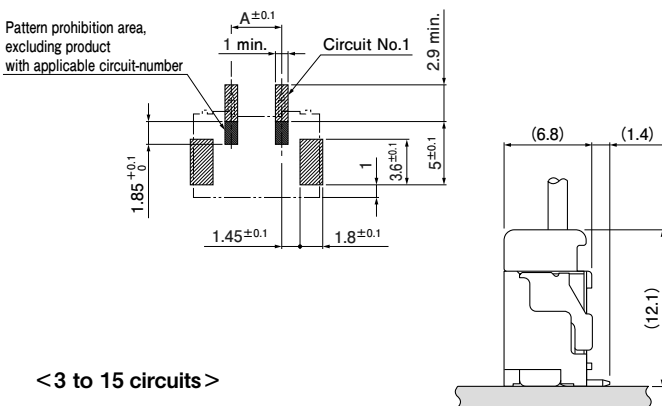

< 3 to 15 circuits >

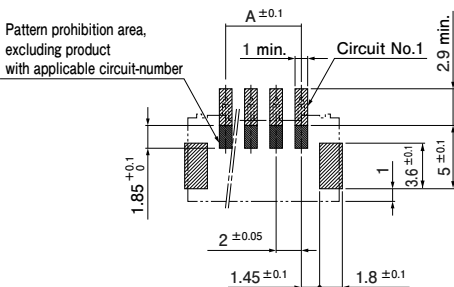

Side entry type

< 2 circuits >

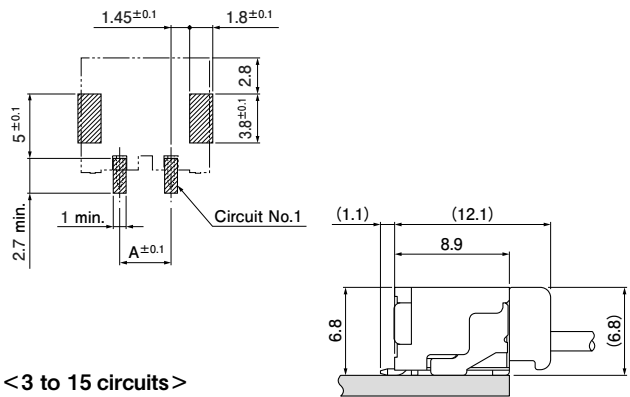

< 3 to 15 circuits >

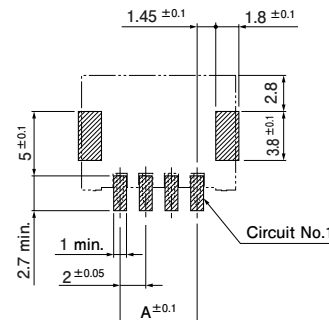

Note: 1. The above figure is the figure viewed from the connector mounting side.

2. Tolerances are non-cumulative: ± 0.03 mm for all centers. The dimensions above should serve as a guideline. Contact JST for details.

PBV CONNECTOR

Contact

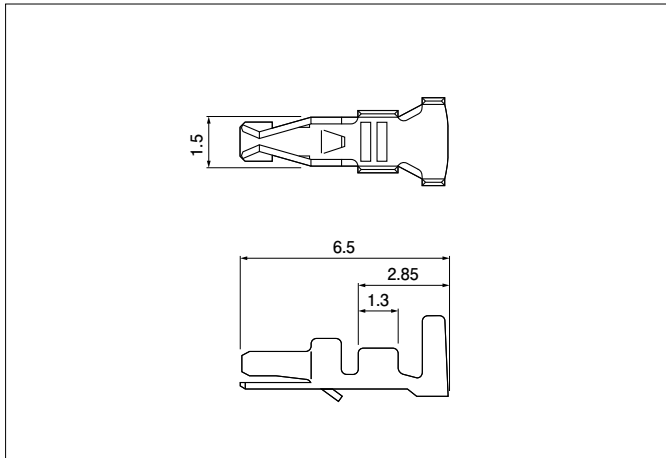

Model No.	Applicable wire		Insulation O.D. (mm)	Q'ty/reel
	mm ²	AWG #		
SPHD-001T-P0.5	0.13~0.33	26~22	1.0~1.5	8,000
SPHD-002T-P0.5	0.08~0.21	28~24	0.9~1.5	8,000

Material and Finish

Phosphor bronze, tin-plated (reflow treatment)

RoHS2 compliance

Contact	Crimping machine	Applicator		
		Crimp applicator	Dies	Crimp applicator with dies
SPHD-001T-P0.5	AP-K2N	MKS-L-10	MK/SPHD-001-05	APLMK SPHD001-05
SPHD-002T-P0.5			MK/SPHD-002-05	APLMK SPHD002-05

Note: Contact JST for fully automatic crimping applicator.

Housing

< 3 (2 circuits in common use) to 8 circuits >

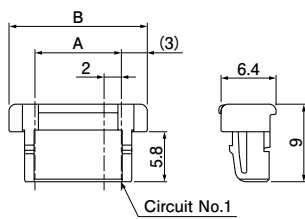

< 9 to 12 circuits >

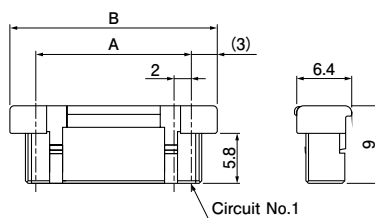

< 13 to 15 circuits >

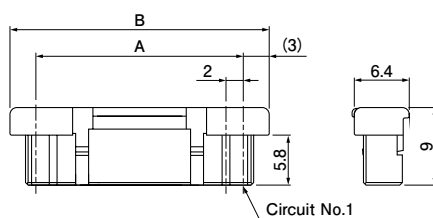

No. of circuits	Model No.	Dimensions (mm)		Q'ty/bag
		A	B	
*3	PBVP-03V-S	4.0	10.0	2,000
4	PBVP-04V-S	6.0	12.0	2,000
6	PBVP-06V-S	10.0	16.0	1,000
8	PBVP-08V-S	14.0	20.0	1,000
10	PBVP-10V-S	18.0	24.0	1,000
12	PBVP-12V-S	22.0	28.0	500
15	PBVP-15V-S	28.0	34.0	500

Material and Finish

PA 66, UL94V-0, natural (white)

RoHS2 compliance

Note*: 2 circuits in common use.

PBV CONNECTOR

Shrouded header

Top entry type

< 2 circuits >

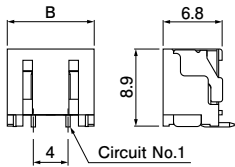

< 3 to 8 circuits >

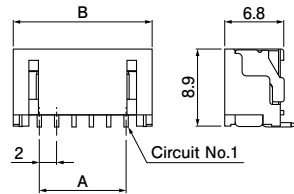

< 9 to 12 circuits >

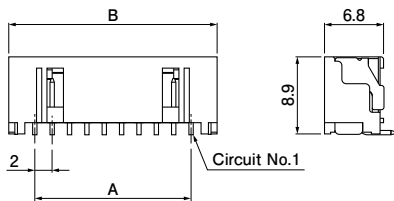

< 13 to 15 circuits >

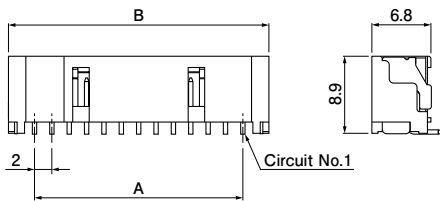

Side entry type

< 2 circuits >

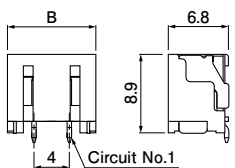

< 3 to 8 circuits >

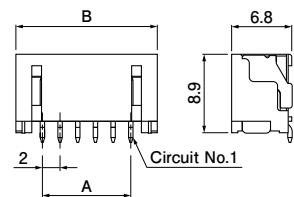

< 9 to 12 circuits >

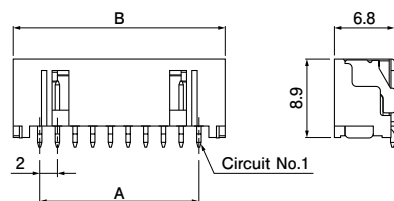

< 13 to 15 circuits >

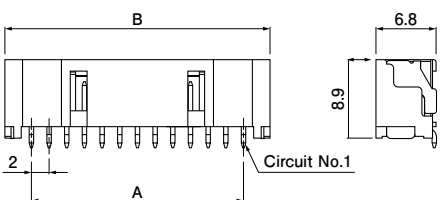

No. of circuits	Model No.		Dimensions (mm)		Q'ty/reel	
	Top entry type	Side entry type	A	B	Top type	Side type
*2	BM02(4.0)B-PBVSS-TF	SM02(4.0)B-PBVSS-TB	4.0	10.0	700	800
3	BM03B-PBVSS-TF	SM03B-PBVSS-TB	4.0	10.0	700	800
4	BM04B-PBVSS-TF	SM04B-PBVSS-TB	6.0	12.0	700	800
6	BM06B-PBVSS-TF	SM06B-PBVSS-TB	10.0	16.0	700	800
8	BM08B-PBVSS-TF	SM08B-PBVSS-TB	14.0	20.0	700	800
10	BM10B-PBVSS-TF	SM10B-PBVSS-TB	18.0	24.0	700	800
12	BM12B-PBVSS-TF	SM12B-PBVSS-TB	22.0	28.0	700	800
15	BM15B-PBVSS-TF	SM15B-PBVSS-TB	28.0	34.0	700	800

Material and Finish

Post: Copper alloy, copper-undercoated, tin-plated (reflow treatment)

Wafer: Polyamide resin, UL94V-0, natural (ivory)

Reinforcement: Copper alloy, copper-undercoated, tin-plated (reflow treatment)

RoHS2 compliance This product displays (LF)(SN) on a label.

Note: 1. These products listed above are supplied on embossed-tape.

2. *2 circuits product: Removing center pin from 3 circuits product

X-ON Electronics

Largest Supplier of Electrical and Electronic Components

Click to view similar products for [Headers & Wire Housings](#) category:

Click to view products by [JST](#) manufacturer:

Other Similar products are found below :

[0015917161](#) [0022155065](#) [57102-F02-18ULF](#) [58102-G61-06LF](#) [582553-1](#) [01.001.5753.1](#) [0050291907](#) [02.125.8002.8](#) [609-3404](#) [61062-3](#)
[CSU011177004](#) [622-0430](#) [622-3653LF](#) [63453-116](#) [636-1030](#) [636-1427](#) [636-3427](#) [636-4007](#) [641938-9](#) [65495-038](#) [65692-001LF](#) [65781-018](#)
[65781-047](#) [65817-010LF](#) [65817-015LF](#) [67095-007LF](#) [67601157](#) [68631-112](#) [68645-018](#) [699319-000](#) [70.362.1628.0](#) [70-4210](#) [70-4226B](#) [70-](#)
[4853B](#) [71.350.2428.0](#) [733-134](#) [733-162](#) [MHR-64-VUAL](#) [80.063.4001.1](#) [800-90-001-10-001000](#) [801-43-002-10-013000](#) [801-43-006-10-](#)
[002000](#) [803-43-024-10-001000](#) [803-93-012-10-001000](#) [8-1437020-4](#) [819-22-004-30-001101](#) [820-22-006-30-001101](#) [820-22-008-30-001101](#)
[821-22-002-10-001101](#) [821-22-003-10-002101](#)