

REV	DESCRIPTION	DATE	DESIGNED

NOTE

1. Unless otherwise specified, tolerances are 0<LS<0.03
5.0<L : ±0.4

2. Part No.: S() B-PUD() S-1 (LF) (SN) Circuits Color code

Color	Part No.
Natural (Ivory)	S () B-PUDS-1 (LF) (SN)
Black	S () B-PUDK-1 (LF) (SN)

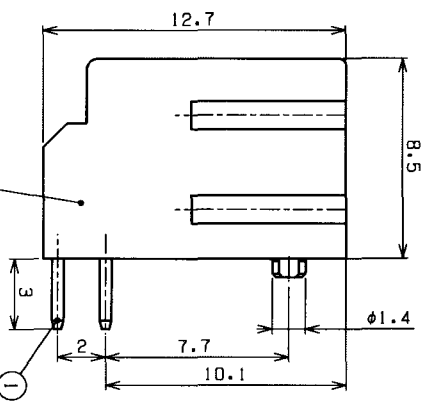
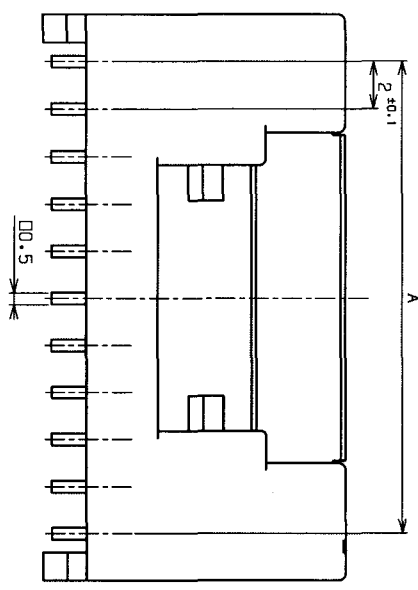
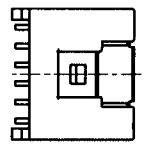
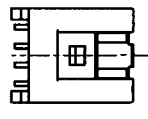
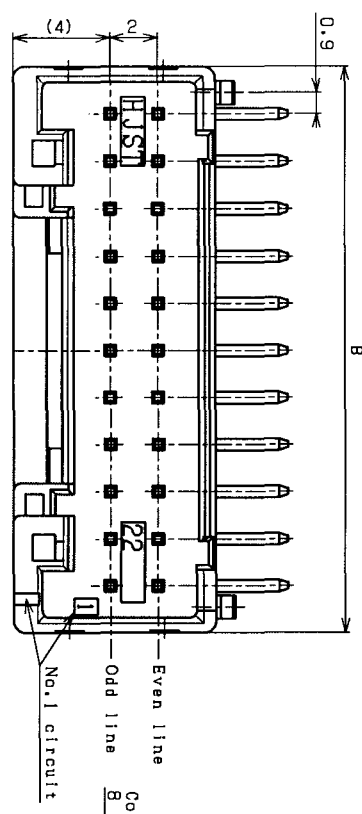

Circuits	Dimensions	
	A	B
8	6.0	10.0
10	8.0	12.0
12	10.0	14.0
14	12.0	16.0
16	14.0	18.0
18	16.0	20.0
20	18.0	22.0
22	20.0	24.0
24	22.0	26.0
26	24.0	28.0
28	26.0	30.0
30	28.0	32.0

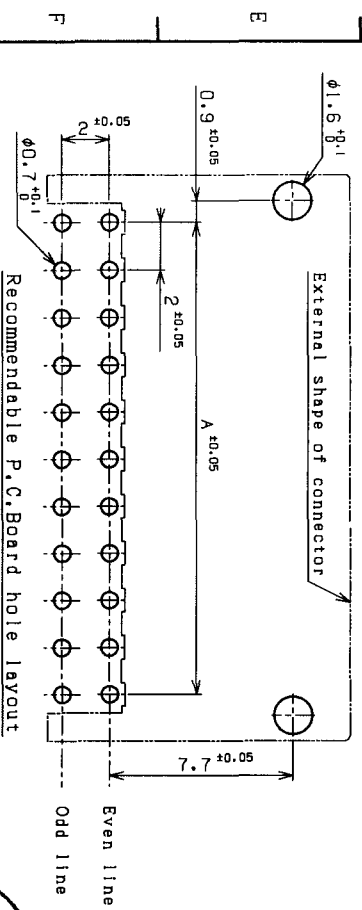

Recommendable P.C.Board hole layout
(Connector mounted side)

2		WAFER	66NYLON (G.F.)	UL94V-0	
1		POST	COPPER ALLOY		
NO.	PART NAME	SCALES	PRODUCTION DATE	MATERIAL	REMARKS
A3	METRIC 5:1		MAR.14.2008		
APPROVED	CHECKED	DESIGNED	DRAWN	CUSTOMER	
S.K	E.N	M.1			
SIZE	UNIT	PART NAME	PRODUCTION DATE	MATERIAL	REMARKS
A3	METRIC	5:1			
SERIES NAME	PART No.	SURFACE FINISH			
PUD CONNECTOR SLIDE TYPE (LEAD-FREE PRODUCT)	S () B-PUD () S-1 (LF) (SN)				
DRAWING No.					
KRD-42384-1					RO

J.S.T. MFG. CO., LTD.

THIS DRAWING CONTAINS INFORMATION THAT IS PROPRIETARY TO J.S.T. AND SHOULD NOT BE USED WITHOUT WRITTEN PERMISSION.

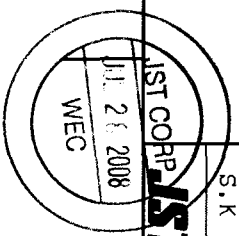

804109-2

X-ON Electronics

Largest Supplier of Electrical and Electronic Components

Click to view similar products for [jst](#) manufacturer:

Other Similar products are found below :

[B08B-JWPF-SK-R](#) [B3PS-VH](#) [B5B-XH-A](#) [B5P-VH](#) [B7B-XH-A](#) [B8B-PH-SM4-TB](#) [GS6-16](#) [B34B-PHDSS-B\(LF\)\(SN\)](#) [B3B-ZR-SM4-TF](#)
[B4B-PH-SM4-TB](#) [B4PS-VH](#) [B5B-PH-SM4-TB](#) [B6B-PH-SM4-TB](#) [B6B-XH-A](#) [B6PS-VH](#) [B7PS-VH](#) [B8B-PH-K-S](#) [IDH-KR-12](#) [10HR-4K](#)
[WC-ZE2426](#) [WC-691](#) [WC-122](#) [FVDDF5.5-375A \(LF\)](#) [FVWS2-S3.3 \(LF\)](#) [FVWS5.5-5 \(LF\)](#) [B6PS-VH\(LF\)\(SN\)](#) [FNGS12-6](#) [TWE0.5-8](#)
[FVGS4-1 \(LF\)](#) [HILR-06VF-1-S](#) [YRS-1090](#) [WC-GVH2630](#) [WC-PUD2](#) [S10B-PH-SM4-TB\(LF\)\(SN\)](#) [B4B-EH-A-TW \(LF\)\(SN\)](#) [B4B-XH-TW](#)
[\(LF\)\(SN\)](#) [B5B-PH-TW-S \(LF\)\(SN\)](#) [B8B-PH-TW-S \(LF\)\(SN\)](#) [B9B-XH-A](#) [BM03B-GHS-TBT](#) [BM04B-GHS-TBT](#) [BM06B-GHS-TBT](#)
[BM10B-GHS-TBT](#) [10FPZ-SM-TF\(LF\)\(SN\)](#) [YRS-852](#) [B04B-VYHSK-M-1](#) [WC-530](#) [B4B-PH-SM4-GW-TB](#) [B2B-ZR-SM4-TFT\(LF\)\(SN\)](#)
[S24B-PADSS-1\(LF\)\(SN\)](#)