

HIL CONNECTOR

3.3mm pitch/Crimp style Wire-to-wire connectors

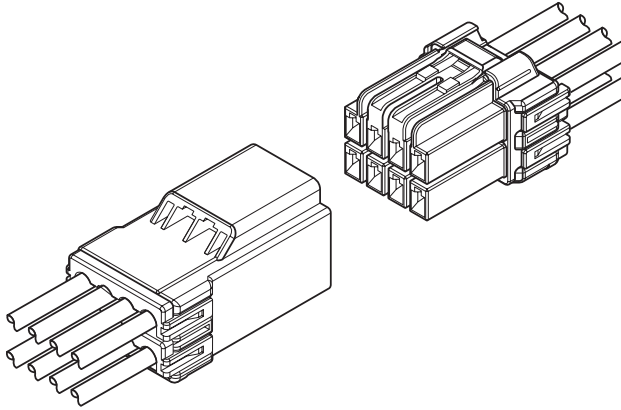

This HIL connector is 3.3mm pitch wire-to-wire connector that has a mechanism to prevent an incomplete mating when mating connector.

- **Inertia lock mechanism to prevent an incomplete mating**
- **Box-shaped contact to prevent the influence by external forces**
- **Polarizing key to prevent connector from mating with incorrect circuits**

Assembly layout

<2, 3 circuits>

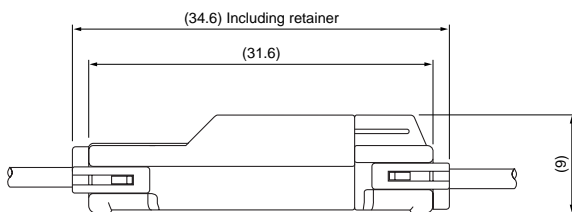

<4, 6, 8 circuits>

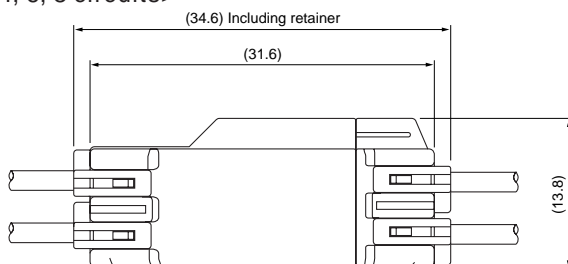

Specifications

- Current rating: 5A AC, DC (2 circuits AWG #18)
 - Voltage rating: 300V AC, DC
 - Temperature range: -25°C to +85°C
(including temperature rise in applying electrical current)
 - Contact resistance: Initial value/10m max.
After environmental testing/20m max.
 - Insulation resistance: 1,000M min.
 - Withstanding voltage: 1,500V AC/minute
 - Applicable wire: Conductor size/01 type AWG #24 to #20
/21 type AWG #22 to #18
Insulation O.D./01 type 1.3 to 2.5mm
/21 type 1.5 to 2.7mm
(when using retainer for 21 type 1.5 to 2.5mm)
- * Compliant with RoHS.
* Refer to "General Instruction and Notice when using Terminals and Connectors" at the end of this catalog.
* Contact JST for details.

Note: The current rating varies depending on the number of circuits and the wire size used in each connector. The table below lists the current rating as a function of the number of circuits and the wire size.

Current unit: A

Circuits	Wire size (AWG)			
	#18	#20	#22	#24
2	5	4	3	3
3	4	4	3	2
4	3	3	2	2
6	3	3	2	2
8	3	3	2	2

List of combinations

Resin color (Plug/ Receptacle)	Natural	Red	Blue
Polarizing key pattern	Polarizing key pattern 1	Polarizing key pattern 2	Polarizing key pattern 3
Plug Model No.	HILP-()V-1-S	HILP-()V-2-R	HILP-()V-3-E
Receptacle Model No.	HILR-()VF-1-S	HILR-()VF-2-R	HILR-()VF-3-E

HIL CONNECTOR

Contact

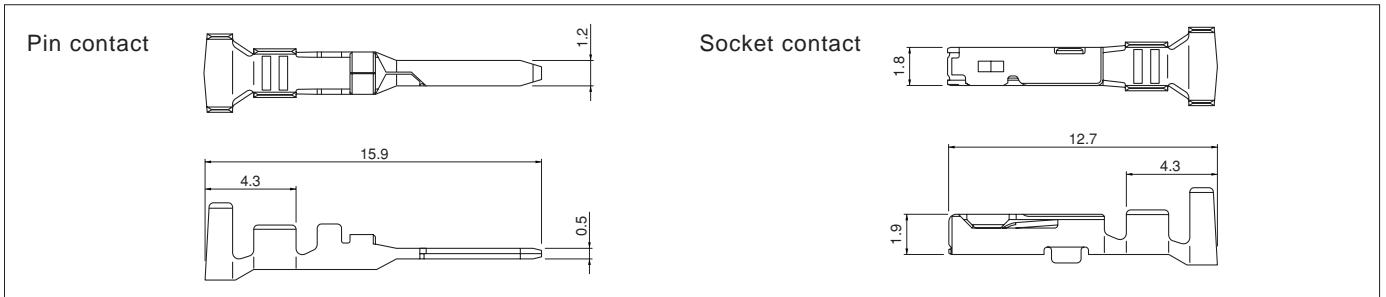

Model No.		Applicable wire		Insulation O.D. (mm)	Q'ty / reel
Pin contact	Socket contact	mm ²	AWG #		
SHIM-01T-P0.5	SHIF-01T-P0.5	0.2~0.5	24~20	1.3~2.5	5,000
SHIM-21T-P0.5	SHIF-21T-P0.5	0.3~0.75	22~18	1.5~2.7	5,000

Material and Finish

Copper alloy, tin-plated

RoHS compliance

Note: Insulation O.D. is 1.5mm to 2.5mm when using retainer for 21 type barrel size contact.

Contact	Crimping machine	Applicator		
		Crimp applicator	Dies	Crimp applicator with dies
SHIM-01T-P0.5	AP-K2N	MKS-L	MK/SHIF/M-01-05	APLMK SHIF/M01-05
SHIM-21T-P0.5			MK/SHIF/M-21-05	APLMK SHIF/M21-05

Contact	Crimping machine	Applicator		
		Crimp applicator	Dies	Crimp applicator with dies
SHIF-01T-P0.5	AP-K2N	MKS-L	MK/SHIF/M-01-05	APLMK SHIF/M01-05
SHIF-21T-P0.5			MK/SHIF/M-21-05	APLMK SHIF/M21-05

Contact position location numbers

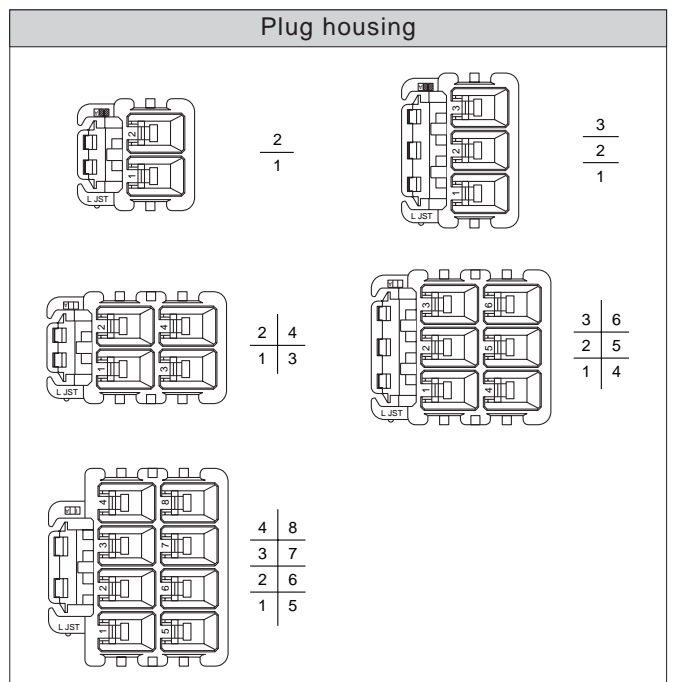
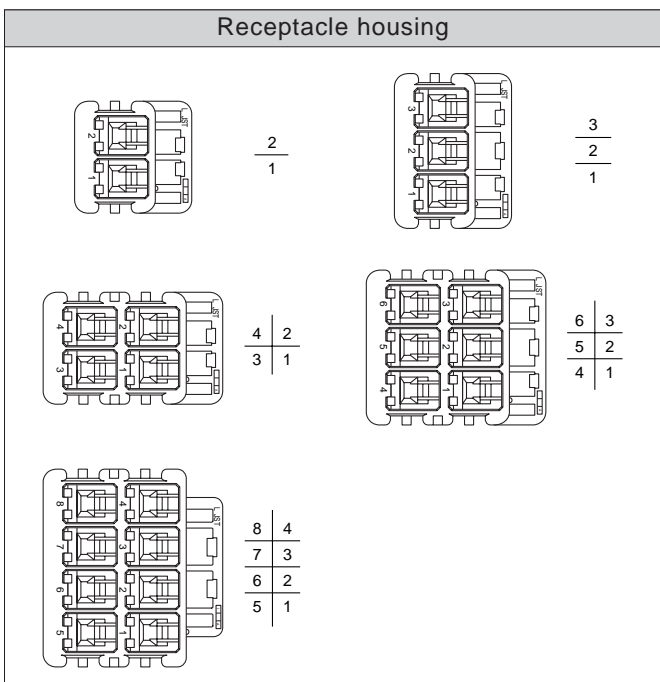
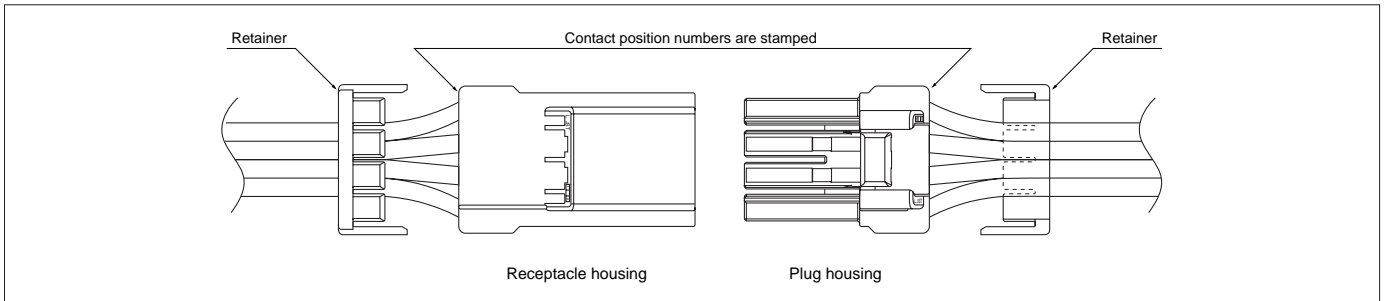

HIL CONNECTOR

Housing

Material: Housing...PA 66, UL94V-0, natural
Retainer...Glass-filled PA 66, UL94V-0, natural

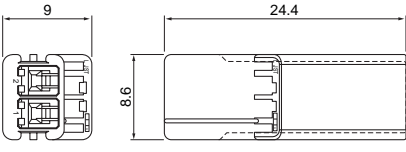
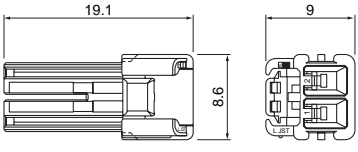
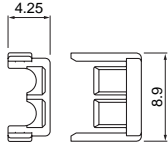
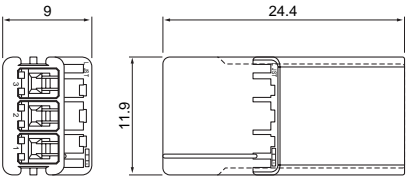
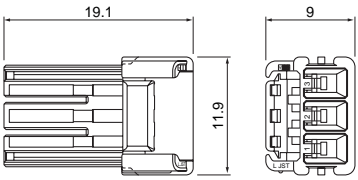
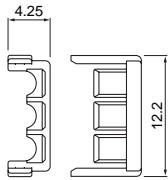
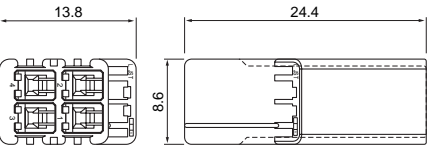
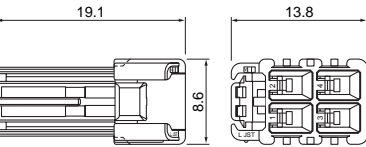
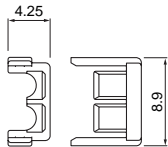
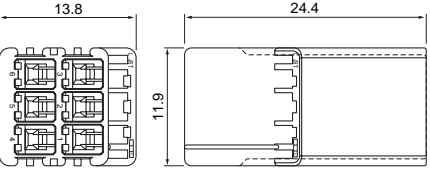
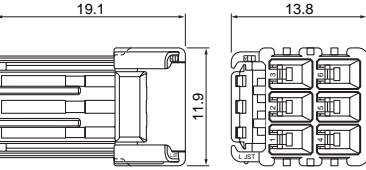
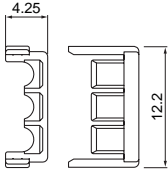
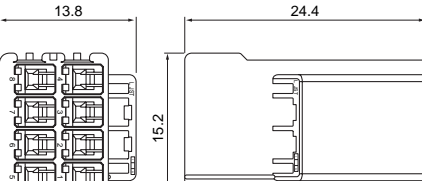
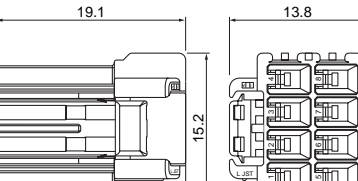
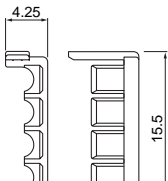
Circuits	Voltage rating	Current rating	Receptacle housing (for pin contact)		Plug housing (for socket contact)		Retainer	
2	300V	5A	HILR-02VF-1-S 	Q'ty / bag 1,000	HILP-02V-1-S 	Q'ty / bag 1,000	HILS-02V (commonly used for 2-circuit housing and 4-circuit housing) 	Q'ty / bag 1,000
3	300V	4A	HILR-03VF-1-S 	Q'ty / bag 1,000	HILP-03V-1-S 	Q'ty / bag 1,000	HILS-03V (commonly used for 3-circuit housing and 6-circuit housing) 	Q'ty / bag 1,000
4	300V	3A	HILR-04VF-1-S 	Q'ty / bag 1,000	HILP-04V-1-S 	Q'ty / bag 1,000	HILS-02V (commonly used for 2-circuit housing and 4-circuit housing) 	Q'ty / bag 1,000
6	300V	3A	HILR-06VF-1-S 	Q'ty / bag 500	HILP-06V-1-S 	Q'ty / bag 1,000	HILS-03V (commonly used for 3-circuit housing and 6-circuit housing) 	Q'ty / bag 1,000
8	300V	3A	HILR-08VF-1-S 	Q'ty / bag 500	HILP-08V-1-S 	Q'ty / bag 1,000	HILS-04V 	Q'ty / bag 1,000

RoHS compliance

Note: Current rating is for use with AWG #18 wire.

X-ON Electronics

Largest Supplier of Electrical and Electronic Components

Click to view similar products for [jst manufacturer](#):

Other Similar products are found below :

[B08B-JWPF-SK-R](#) [B3PS-VH](#) [B5B-XH-A](#) [B5P-VH](#) [B7B-XH-A](#) [B8B-PH-SM4-TB](#) [GS6-16](#) [B34B-PHDSS-B\(LF\)\(SN\)](#) [B3B-ZR-SM4-TF](#)
[B4B-PH-SM4-TB](#) [B4PS-VH](#) [B5B-PH-SM4-TB](#) [B6B-PH-SM4-TB](#) [B6B-XH-A](#) [B6PS-VH](#) [B7PS-VH](#) [B8B-PH-K-S](#) [IDH-KR-12](#) [10HR-4K](#)
[WC-ZE2426](#) [WC-691](#) [WC-122](#) [FVDDF5.5-375A \(LF\)](#) [FVWS2-S3.3 \(LF\)](#) [FVWS5.5-5 \(LF\)](#) [B6PS-VH\(LF\)\(SN\)](#) [FNGS12-6](#) [TWE0.5-8](#)
[FVGS4-1 \(LF\)](#) [HILR-06VF-1-S](#) [YRS-1090](#) [WC-GVH2630](#) [WC-PUD2](#) [S10B-PH-SM4-TB\(LF\)\(SN\)](#) [B4B-EH-A-TW \(LF\)\(SN\)](#) [B4B-XH-TW](#)
[\(LF\)\(SN\)](#) [B5B-PH-TW-S \(LF\)\(SN\)](#) [B8B-PH-TW-S \(LF\)\(SN\)](#) [B9B-XH-A](#) [BM03B-GHS-TBT](#) [BM04B-GHS-TBT](#) [BM06B-GHS-TBT](#)
[BM10B-GHS-TBT](#) [10FPZ-SM-TF\(LF\)\(SN\)](#) [YRS-852](#) [B04B-VYHSK-M-1](#) [WC-530](#) [B4B-PH-SM4-GW-TB](#) [B2B-ZR-SM4-TFT\(LF\)\(SN\)](#)
[S24B-PADSS-1\(LF\)\(SN\)](#)