



PA FAMILY SERIES/PA•PAF•PAL CONNECTOR

2.0mm pitch/Wire-to-board (Crimp style/IDC) / Wire-to-wire (Crimp style/IDC)



Based upon wire-to-board crimp style PA connectors, the PA series family of connector have been expanded to meet the requirement of complex wire harness of 2.0 mm pitch connectors with secure locking mechanism thanks to the additional line up of wire-to-board IDC style PAF connectors and wire-to-wire crimp style PAL connectors.

- **Secure locking device**
- **Interchangeable between crimp and IDC socket**
- **Secondary retainers**
- **Harness variation**

PA connector (Standard type, Retainer mountable type)

- **Highly reliable contact**
- **Insertion guide mechanism**
- **Flanged press pin**

PAF connector

- **The industry's first secure lock ID connectors**
- **Metallic strain relief**
- **Retainer with four locking points**

PAL connector

- **The industry's first wire to wire 2.0 mm pitch retainer mountable type connector.**
- **Either with or without panel lock can be selected according to application.**

Standards

Recognized E60389

Certified LR20812

Specifications

PA Connector (Standard type)

- Current rating: 3 A AC, DC (AWG #22)
- Voltage rating: 250 V AC, DC
- Temperature range: -25°C to +85°C
(including temperature rise in applying electrical current)
- Contact resistance: Initial value/ 10 mΩ max.
After environmental tests/ 20 mΩ max.
- Insulation resistance: Initial/ 1,000 MΩ min.
- Withstanding voltage: 800 VAC/minute
- Applicable wire: Conductor size/ AWG #28 to #22
Insulation O.D./ 0.76 to 1.5 mm
- Applicable PC board thickness: 1.6 mm

PA Connector (Retainer mountable type)

- Current rating: 3 A AC, DC (AWG #22)
- Voltage rating: 100 V AC, DC
- Temperature range: -25°C to +85°C
(including temperature rise in applying electrical current)
- Contact resistance: Initial value/ 15 mΩ max.
After environmental tests/ 25 mΩ max.
- Insulation resistance: Initial/ 1,000 MΩ min.
- Withstanding voltage: 800 V AC/minute
- Applicable wire: AWG #26 to #22

PAF Connector

- Current rating: 1.0 A AC, DC (AWG #26)
- Voltage rating: 100 V AC, DC
- Temperature range: -25°C to +85°C
(including temperature rise in applying electrical current)
- Contact resistance: Initial value/ 15 mΩ max.
After environmental tests/ 25 mΩ max.
- Insulation resistance: Initial/ 1,000 MΩ min.
- Withstanding voltage: 800 VAC/minute
- Applicable wire: UL1061(Contact JST for details regarding other UL wires.)
AWG #26
Conductor/ 7 strands, tin-coated annealed copper
Insulation O.D./ 0.9 to 1.0 mm

PAL Connector

- Current rating: 3 A AC, DC (AWG #22)
- Voltage rating: 100 V AC, DC
- Temperature range: -25°C to +85°C
(including temperature rise in applying electrical current)
- Contact resistance: Initial value/ 15 mΩ max.
After environmental tests/ 25 mΩ max.
- Insulation resistance: Initial/ 1,000 MΩ min.
- Withstanding voltage: 800 VAC/minute
- Applicable wire: AWG #28 to #22
- Applicable panel thickness : 0.5 to 2.0 mm



* Refer to "General Instruction and Notice when using Terminals and Connectors" at the end of this catalog.

* Contact JST for details.

* Compliant with RoHS.

PA FAMILY SERIES /PA•PAF•PAL CONNECTOR

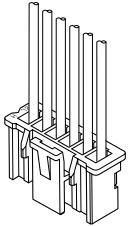
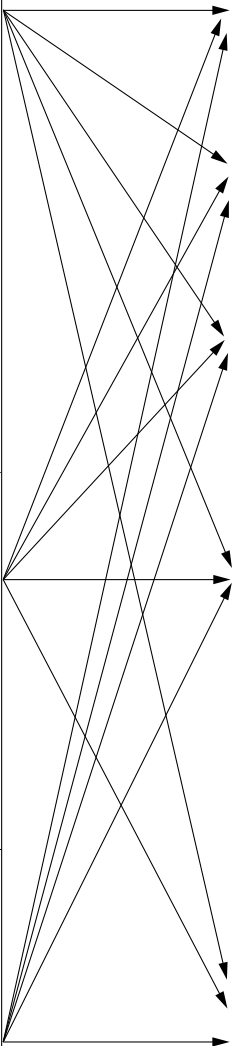
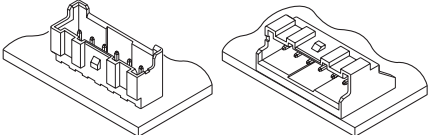
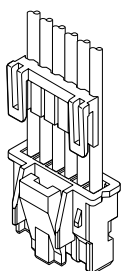
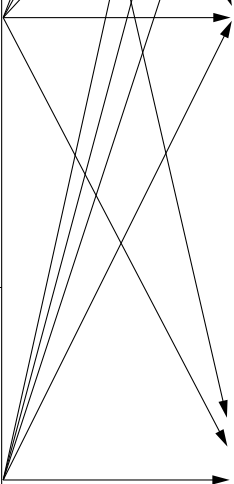
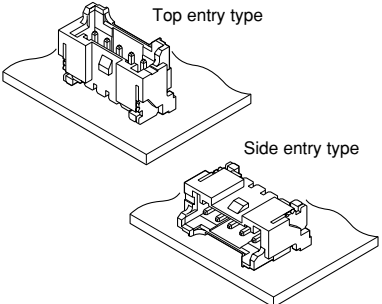
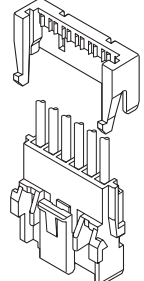
List of combinations

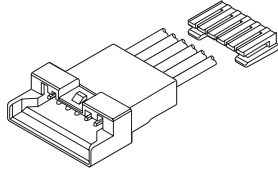
| | | | | |
|--|---|---|---|--|
| <p>Crimp style Standard type</p>  | <p><u>Contact</u> SPHD-001T-P0.5 SPHD-002T-P0.5</p> <p><u>Housing</u> PAP-()V-S</p> |  | <p><u>Shrouded header</u> B()B-PASK B()B-PASK-1 B()B-PASK-N B()B-PASK-1N S()B-PASK-2</p> | <p>Top entry type Side entry type</p>  |
| <p>Crimp style Retainer mountable type</p>  | <p><u>Contact</u> SPA-001T-P0.5</p> <p><u>Housing</u> PARP-()V</p> <p><u>Retainer</u> PMS-()V-S</p> |  | <p><u>Shrouded header</u> BM()B-PASS BM()B-PASS-1 SM()B-PASS SM()B-PASS-1</p> | <p>SMT type</p> <p>Top entry type</p> <p>Side entry type</p>  |
| <p>Insulation displacement type</p>  | <p><u>Receptacle</u> ()PAF-6S</p> <p><u>Retainer</u> PAFS-()V-S</p> |  | <p><u>Contact</u> SPAL-001T-P0.5 SPAL-002T-P0.5</p> <p><u>Receptacle housing</u> PALR-()V(F)</p> <p><u>Retainer</u> PMS-()V-S</p> | <p>Wire to wire Connectors</p>  |

PA FAMILY SERIES /PA•PAF•PAL CONNECTOR

PC board layout and Assembly layout

<Through-hole type>

Top entry type



PA Receptacle
(Standard type)
+
PA Header



PA Receptacle
(Retainer mountable type)
+
PA Header

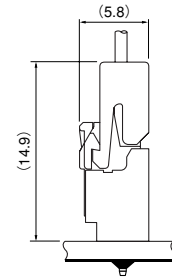

PAF Receptacle
+
PA Header

Side entry type



PA Receptacle
(Standard type)
+
PA side entry type header

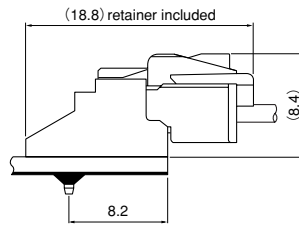

PA Receptacle
(Retainer mountable type)
+
PA side entry type header

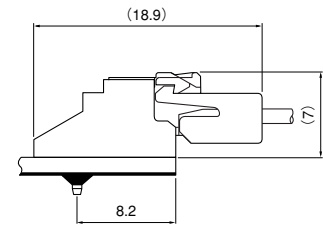

PAF Receptacle
+
PA side entry type header

Bottom type

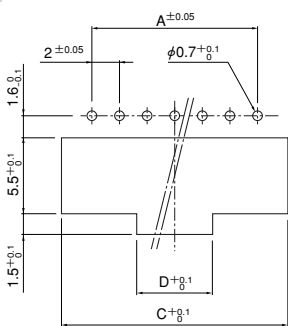

Note: Dimensions C and D; Refer to the header bottom type.

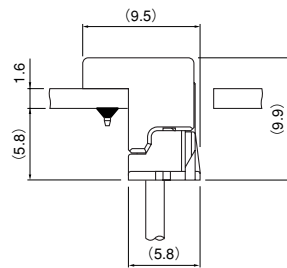

PA Receptacle
(Standard type)
+
PA bottom type header
(Extended length type)



PA Receptacle
(Retainer mountable type)
+
PA bottom type header
(Extended length type)



PAF Receptacle
+
PA bottom type header
(Extended length type)

Bottom type with extended length



Note: Dimensions C; Refer to the header bottom type.

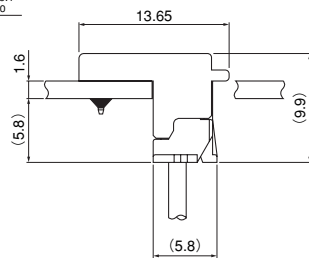

PA Receptacle
(Standard type)
+
PA bottom type header
(Extended length type)



PA Receptacle
(Retainer mountable type)
+
PA bottom type header
(Extended length type)



PAF Receptacle
+
PA bottom type header
(Extended length type)

Note: 1. The above figure is the figure viewed from the connector mounting side.

2. Tolerances are non-cumulative: ±0.05 mm for all centers.

3. Hole dimensions differ according to the type of PC board and piercing method. The dimensions above should serve as a guideline. Contact JST for details.

PA FAMILY SERIES /PA•PAF•PAL CONNECTOR

PC board layout and Assembly layout

High box type



Note: 1. The above figure is the figure viewed from the connector mounting side.

2. Tolerances are non-cumulative: ± 0.05 mm for all centers.

3. Hole dimensions differ according to the type of PC board and piercing method. The dimensions above should serve as a guideline. Contact JST for details.

<SMT type>

Top entry type

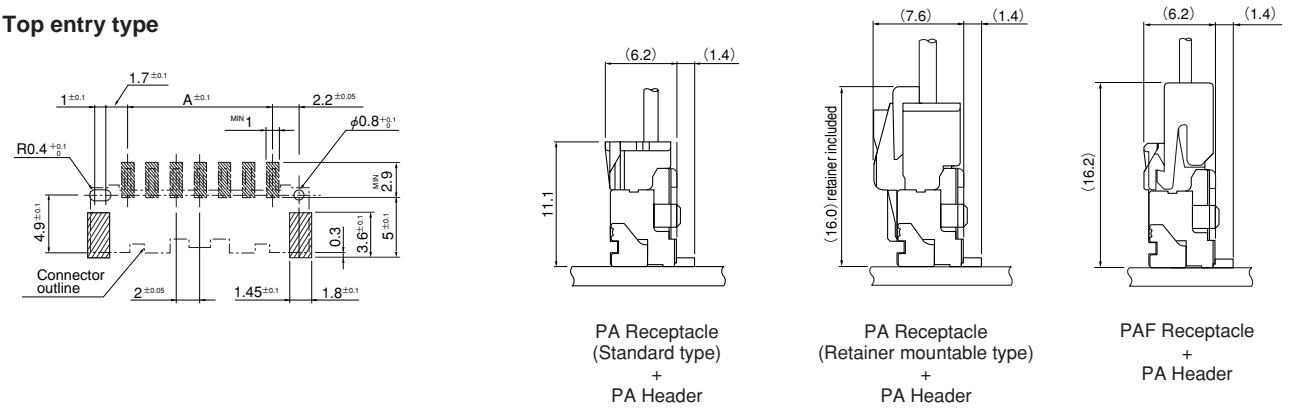

Side entry type



Note: 1. The above figure is the figure viewed from the connector mounting side.

2. Tolerances for the centers of pattern on PCB is ± 0.05 , and shall be not cumulative more than ± 0.1 .

3. The dimensions above should serve as a guideline. Contact JST for details.

<Wire-to-wire>



PA FAMILY SERIES /PA CONNECTOR (Crimp style Standard type)

Contact



| Model No. | Applicable wire | | Insulation O.D. (mm) | Q'ty/reel |
|-----------------------|-----------------|-------|----------------------|-----------|
| | mm ² | AWG # | | |
| SPHD-001T-P0.5 | 0.13~0.33 | 26~22 | 1.0~1.5 | 8,000 |
| SPHD-002T-P0.5 | 0.08~0.21 | 28~24 | 0.76~1.5 | 8,000 |

Material and Finish

Phosphor bronze, tin-plated (reflow treatment)

RoHS compliance

| Contact | Crimping machine | Applicator | | |
|-----------------------|------------------|------------------|----------------|----------------------------|
| | | Crimp applicator | Dies | Crimp applicator with dies |
| SPHD-002T-P0.5 | AP-K2N | MKS-L-10 | MK/SPHD-002-05 | APLMK SPHD002-05 |
| | | *MKS-SC-10 | SC/SPHD-002-05 | APLSC SPHD002-05 |
| SPHD-001T-P0.5 | | MKS-L-10 | MK/SPHD-001-05 | APLMK SPHD001-05 |
| | | *MKS-SC-10 | SC/SPHD-001-05 | APLSC SPHD001-05 |

Note: *Strip-crimp applicator

Housing

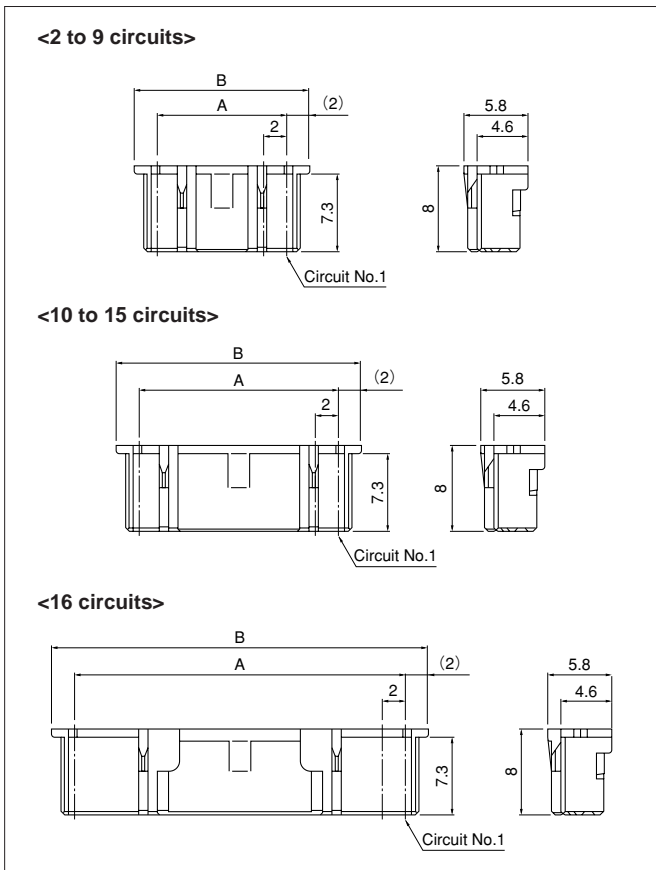

| Circuits | Model No. | Dimensions (mm) | | Q'ty/bag |
|----------|------------------|-----------------|------|----------|
| | | A | B | |
| 2 | PAP-02V-S | 2.0 | 6.0 | 1,000 |
| 3 | PAP-03V-S | 4.0 | 8.0 | 1,000 |
| 4 | PAP-04V-S | 6.0 | 10.0 | 1,000 |
| 5 | PAP-05V-S | 8.0 | 12.0 | 1,000 |
| 6 | PAP-06V-S | 10.0 | 14.0 | 1,000 |
| 7 | PAP-07V-S | 12.0 | 16.0 | 1,000 |
| 8 | PAP-08V-S | 14.0 | 18.0 | 1,000 |
| 9 | PAP-09V-S | 16.0 | 20.0 | 1,000 |
| 10 | PAP-10V-S | 18.0 | 22.0 | 1,000 |
| 11 | PAP-11V-S | 20.0 | 24.0 | 1,000 |
| 12 | PAP-12V-S | 22.0 | 26.0 | 1,000 |
| 13 | PAP-13V-S | 24.0 | 28.0 | 1,000 |
| 14 | PAP-14V-S | 26.0 | 30.0 | 1,000 |
| 15 | PAP-15V-S | 28.0 | 32.0 | 1,000 |
| 16 | PAP-16V-S | 30.0 | 34.0 | 1,000 |

Material

PA 66, UL94V-0, natural (white)

RoHS compliance

<For reference> As the color identification, the following alphabet shall be put in the underlined part. For availability, delivery and minimum order quantity, contact JST.

ex. **PAP-02V-S**

S...natural (white)

K...black R...red E...blue M...green O...orange N...brown

P...purple PK...pink Y...yellow L...lemon yellow FY...vivid yellow

LE...light blue H...gray TR...tomato red

Through-hole type shrouded header

Top entry type

<2 to 9 circuits>



<10 to 15 circuits>



<16 circuits>

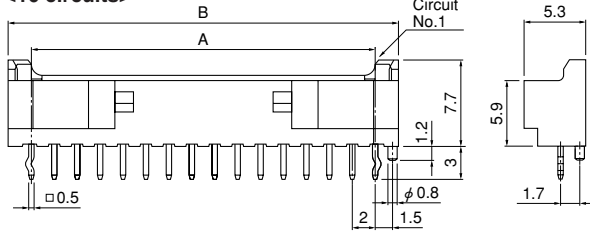

Side entry type

<2 to 9 circuits>



<10 to 15 circuits>



<16 circuits>

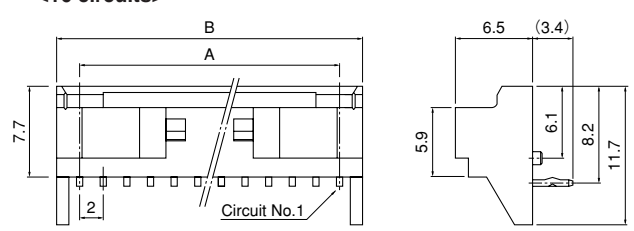

Top entry type

| Circuits | Model No. | | Dimensions (mm) | | Q'ty/box |
|-----------|---------------------|----------------------|-----------------|------|----------|
| | Without boss | With a boss | A | B | |
| 2 (Note1) | B02B-PAFYK-A | B02B-PAFYK-1A | 2.0 | 6.0 | 1,000 |
| 2 | B02B-PASK | B02B-PASK-1 | 2.0 | 6.0 | 1,000 |
| 3 | B03B-PASK | B03B-PASK-1 | 4.0 | 8.0 | 1,000 |
| 4 | B04B-PASK | B04B-PASK-1 | 6.0 | 10.0 | 1,000 |
| 5 | B05B-PASK | B05B-PASK-1 | 8.0 | 12.0 | 500 |
| 6 | B06B-PASK | B06B-PASK-1 | 10.0 | 14.0 | 500 |
| 7 | B07B-PASK | B07B-PASK-1 | 12.0 | 16.0 | 500 |
| 8 | B08B-PASK | B08B-PASK-1 | 14.0 | 18.0 | 500 |
| 9 | B09B-PASK | B09B-PASK-1 | 16.0 | 20.0 | 500 |
| 10 | B10B-PASK | B10B-PASK-1 | 18.0 | 22.0 | 500 |
| 11 | B11B-PASK | B11B-PASK-1 | 20.0 | 24.0 | 250 |
| 12 | B12B-PASK | B12B-PASK-1 | 22.0 | 26.0 | 250 |
| 13 | B13B-PASK | B13B-PASK-1 | 24.0 | 28.0 | 250 |
| 14 | B14B-PASK | B14B-PASK-1 | 26.0 | 30.0 | 250 |
| 15 | B15B-PASK | B15B-PASK-1 | 28.0 | 32.0 | 250 |
| 16 | B16B-PASK | B16B-PASK-1 | 30.0 | 34.0 | 250 |

Material and Finish

Post: Copper alloy, copper-undercoated, tin-plated (reflow treatment)
Wafer: Glass-filled PBT, UL94V-0, natural (white)
(Note1) PA 66, UL94V-0, vivid yellow

RoHS compliance This product displays (LF)(SN) on a label.

<For reference> As the color identification, the following alphabet shall be put in the underlined part. For availability, delivery and minimum order quantity, contact JST.

ex. **B02B-PASK**

S...natural (white)
K...black R...red E...blue M...green O...orange N...brown
P...purple PK...pink Y...yellow L...lemon yellow FY...vivid yellow
LE...light blue H...gray TR...tomato red

Side entry type

| Circuits | Model No. | Dimensions (mm) | | Q'ty/box |
|----------|--------------------|-----------------|------|----------|
| | | A | B | |
| 2 | S02B-PASK-2 | 2.0 | 6.0 | 1,000 |
| 3 | S03B-PASK-2 | 4.0 | 8.0 | 1,000 |
| 4 | S04B-PASK-2 | 6.0 | 10.0 | 500 |
| 5 | S05B-PASK-2 | 8.0 | 12.0 | 500 |
| 6 | S06B-PASK-2 | 10.0 | 14.0 | 500 |
| 7 | S07B-PASK-2 | 12.0 | 16.0 | 250 |
| 8 | S08B-PASK-2 | 14.0 | 18.0 | 250 |
| 9 | S09B-PASK-2 | 16.0 | 20.0 | 250 |
| 10 | S10B-PASK-2 | 18.0 | 22.0 | 250 |
| 11 | S11B-PASK-2 | 20.0 | 24.0 | 250 |
| 12 | S12B-PASK-2 | 22.0 | 26.0 | 250 |
| 13 | S13B-PASK-2 | 24.0 | 28.0 | 200 |
| 14 | S14B-PASK-2 | 26.0 | 30.0 | 200 |
| 15 | S15B-PASK-2 | 28.0 | 32.0 | 200 |
| 16 | S16B-PASK-2 | 30.0 | 34.0 | 200 |

Material and Finish

Post: Copper alloy, copper-undercoated, tin-plated (reflow treatment)
Wafer: Glass-filled PBT, UL94V-0, natural (white)

RoHS compliance This product displays (LF)(SN) on a label.

<For reference> As the color identification, the following alphabet shall be put in the underlined part. For availability, delivery and minimum order quantity, contact JST.

ex. **S03B-PASK-2**

S...natural (white)
K...black R...red E...blue M...green O...orange N...brown
P...purple PK...pink Y...yellow L...lemon yellow LE...light blue
H...gray TR...tomato red

Through-hole type shrouded header

N type

<2 to 9 circuits>



<10 to 15 circuits>



<16 circuits>



Bottom type

<5, 8 circuits>



<11, 12 circuits>



Bottom type with extended length



N type

| Circuits | Model No. | | Dimensions (mm) | | Q'ty/box |
|----------|--------------|--------------|-----------------|------|----------|
| | Without boss | With a boss | A | B | |
| 2 | B02B-PASK-N | B02B-PASK-1N | 2.0 | 6.0 | 1,000 |
| 3 | B03B-PASK-N | B03B-PASK-1N | 4.0 | 8.0 | 1,000 |
| 4 | B04B-PASK-N | B04B-PASK-1N | 6.0 | 10.0 | 1,000 |
| 5 | B05B-PASK-N | B05B-PASK-1N | 8.0 | 12.0 | 500 |
| 6 | B06B-PASK-N | B06B-PASK-1N | 10.0 | 14.0 | 500 |
| 7 | B07B-PASK-N | B07B-PASK-1N | 12.0 | 16.0 | 500 |
| 8 | B08B-PASK-N | B08B-PASK-1N | 14.0 | 18.0 | 500 |
| 9 | B09B-PASK-N | B09B-PASK-1N | 16.0 | 20.0 | 500 |
| 10 | B10B-PASK-N | B10B-PASK-1N | 18.0 | 22.0 | 500 |
| 11 | B11B-PASK-N | B11B-PASK-1N | 20.0 | 24.0 | 250 |
| 12 | B12B-PASK-N | B12B-PASK-1N | 22.0 | 26.0 | 250 |
| 13 | B13B-PASK-N | B13B-PASK-1N | 24.0 | 28.0 | 250 |
| 14 | B14B-PASK-N | B14B-PASK-1N | 26.0 | 30.0 | 250 |
| 15 | B15B-PASK-N | B15B-PASK-1N | 28.0 | 32.0 | 250 |
| 16 | B16B-PASK-N | B16B-PASK-1N | 30.0 | 34.0 | 250 |

Material and Finish

Post: Copper alloy, copper-undercoated, tin-plated (reflow treatment)
Wafer: Glass-filled PA 66, UL94V-0, natural

RoHS compliance This product displays (LF)(SN) on a label.

Bottom type

| Circuits | Model No. | Dimensions (mm) | | | | Q'ty/bag |
|----------|------------|-----------------|------|------|------|----------|
| | | A | B | C | D | |
| 5 | BE05B-PASK | 8.0 | 12.0 | 12.4 | 5.5 | 300 |
| 8 | BE08B-PASK | 14.0 | 18.0 | 18.4 | 5.5 | 200 |
| 11 | BE11B-PASK | 20.0 | 24.0 | 24.4 | 12.0 | 150 |
| 12 | BE12B-PASK | 22.0 | 26.0 | 26.4 | 12.0 | 150 |

Material and Finish

Post: Copper alloy, copper-undercoated, tin-plated (reflow treatment)
Wafer: Glass-filled PBT, UL94V-0, natural

RoHS compliance This product displays (LF)(SN) on a label.

Note: Dimensions C and D; Refer to the PCB layout bottom type (page 3).

Bottom type with extended length

| Circuits | Model No. | Dimensions (mm) | | | Q'ty/box |
|----------|--------------|-----------------|------|------|----------|
| | | A | B | C | |
| 4 | BE04B-PASK-C | 6.0 | 10.0 | 10.4 | 1,050 |
| 5 | BE05B-PASK-C | 8.0 | 12.0 | 12.4 | 875 |
| 6 | BE06B-PASK-C | 10.0 | 14.0 | 14.4 | 750 |

Material and Finish

Post: Copper alloy, copper-undercoated, tin-plated (reflow treatment)
Wafer: Glass-filled PA 66, UL94V-0, natural

RoHS compliance This product displays (LF)(SN) on a label.

Note: 1. Dimensions C; Refer to the PCB layout bottom type (page 3).

2. Not UL/CSA approved.

Shrouded header <High box type>

<2 circuits>



<5, 6 circuits>



<3 circuits>



<7 to 9 circuits>



<4 circuits>

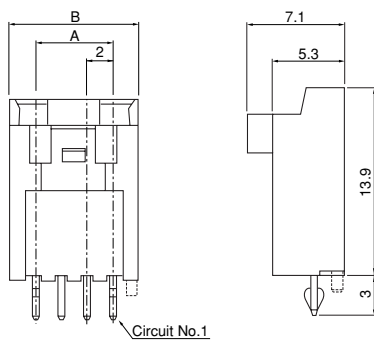

<10 to 12, 15 circuits>



| Circuits | Model No. | | Dimensions(mm) | | Q'ty/ box |
|----------|----------------|--------------|----------------|------|--------------|
| | Without a boss | With a boss | A | B | |
| 2 | BH02B-PASK | BH02B-PASK-1 | 2.0 | 6.0 | 900 |
| 3 | BH03B-PASK | BH03B-PASK-1 | 4.0 | 8.0 | 675 |
| 4 | BH04B-PASK | BH04B-PASK-1 | 6.0 | 10.0 | 525 |
| 5 | BH05B-PASK | BH05B-PASK-1 | 8.0 | 12.0 | 450 |
| 6 | BH06B-PASK | BH06B-PASK-1 | 10.0 | 14.0 | 375 |
| 7 | BH07B-PASK | BH07B-PASK-1 | 12.0 | 16.0 | 325 |
| 8 | BH08B-PASK | BH08B-PASK-1 | 14.0 | 18.0 | 300 |
| 9 | BH09B-PASK | BH09B-PASK-1 | 16.0 | 20.0 | 250 |
| 10 | BH10B-PASK | BH10B-PASK-1 | 18.0 | 22.0 | 225 |
| 11 | BH11B-PASK | BH11B-PASK-1 | 20.0 | 24.0 | 225 |
| 12 | BH12B-PASK | BH12B-PASK-1 | 22.0 | 26.0 | 200 |
| 15 | BH15B-PASK | BH15B-PASK-1 | 28.0 | 32.0 | 150 |

Material and Finish

Post: Copper alloy, copper-undercoated, tin-plated (reflow treatment)

Wafer: Glass-filled PBT, UL94V-0, natural (white)

RoHS compliance This product displays (LF)(SN) on a label.

PA FAMILY SERIES

SMT type shrouded header

Top entry type

<2 to 3 circuits>

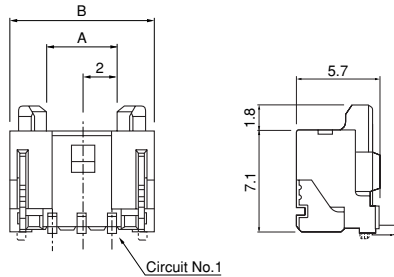

<4 to 9 circuits>



<10 to 13, 15 circuits>

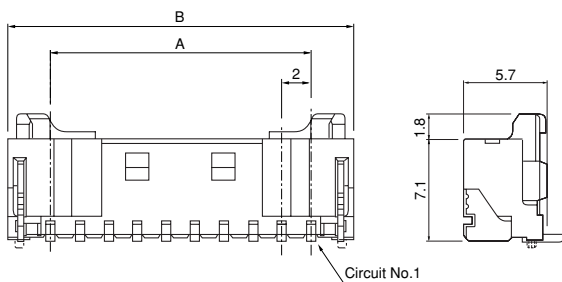

Side entry type

<2 to 3 circuits>



<4 to 9 circuits>

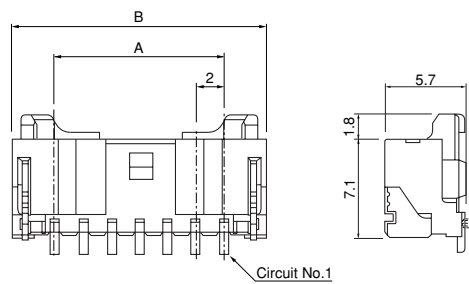

<10 to 13, 15 circuits>

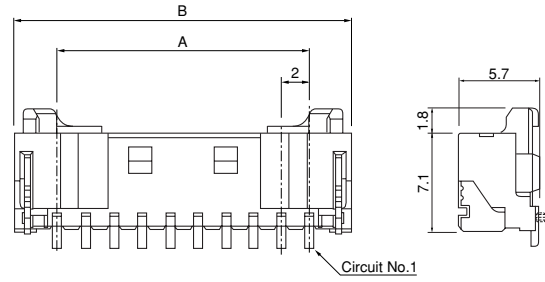

Top entry type

| Circuits | Model No. | | Dimensions(mm) | | Q'ty/ reel |
|----------|----------------|------------------|----------------|------|---------------|
| | Without a boss | With a boss | A | B | |
| 2 | BM02B-PASS-(*) | BM02B-PASS-1-(*) | 2.0 | 8.0 | 500 |
| 3 | BM03B-PASS-(*) | BM03B-PASS-1-(*) | 4.0 | 10.0 | 500 |
| 4 | BM04B-PASS-(*) | BM04B-PASS-1-(*) | 6.0 | 12.0 | 500 |
| 5 | BM05B-PASS-(*) | BM05B-PASS-1-(*) | 8.0 | 14.0 | 500 |
| 6 | BM06B-PASS-(*) | BM06B-PASS-1-(*) | 10.0 | 16.0 | 500 |
| 7 | BM07B-PASS-(*) | BM07B-PASS-1-(*) | 12.0 | 18.0 | 500 |
| 8 | BM08B-PASS-(*) | BM08B-PASS-1-(*) | 14.0 | 20.0 | 500 |
| 9 | BM09B-PASS-(*) | BM09B-PASS-1-(*) | 16.0 | 22.0 | 500 |
| 10 | BM10B-PASS-(*) | BM10B-PASS-1-(*) | 18.0 | 24.0 | 500 |
| 11 | BM11B-PASS-(*) | BM11B-PASS-1-(*) | 20.0 | 26.0 | 500 |
| 12 | BM12B-PASS-(*) | BM12B-PASS-1-(*) | 22.0 | 28.0 | 500 |
| 13 | BM13B-PASS-(*) | BM13B-PASS-1-(*) | 24.0 | 30.0 | 500 |
| 15 | BM15B-PASS-(*) | BM15B-PASS-1-(*) | 28.0 | 34.0 | 500 |

Material and Finish

Post: Copper alloy, copper-undercoated, tin-plated (reflow treatment)
 Wafer: PA, UL94V-0, natural (ivory)
 Solder tab: Copper alloy, copper-undercoated, tin-plated (reflow treatment)

Side entry type

| Circuits | Model No. | | Dimensions(mm) | | Q'ty/ reel |
|----------|----------------|------------------|----------------|------|---------------|
| | Without a boss | With a boss | A | B | |
| 2 | SM02B-PASS-(*) | SM02B-PASS-1-(*) | 2.0 | 8.0 | 1,000 |
| 3 | SM03B-PASS-(*) | SM03B-PASS-1-(*) | 4.0 | 10.0 | 1,000 |
| 4 | SM04B-PASS-(*) | SM04B-PASS-1-(*) | 6.0 | 12.0 | 1,000 |
| 5 | SM05B-PASS-(*) | SM05B-PASS-1-(*) | 8.0 | 14.0 | 1,000 |
| 6 | SM06B-PASS-(*) | SM06B-PASS-1-(*) | 10.0 | 16.0 | 1,000 |
| 7 | SM07B-PASS-(*) | SM07B-PASS-1-(*) | 12.0 | 18.0 | 1,000 |
| 8 | SM08B-PASS-(*) | SM08B-PASS-1-(*) | 14.0 | 20.0 | 1,000 |
| 9 | SM09B-PASS-(*) | SM09B-PASS-1-(*) | 16.0 | 22.0 | 1,000 |
| 10 | SM10B-PASS-(*) | SM10B-PASS-1-(*) | 18.0 | 24.0 | 1,000 |
| 11 | SM11B-PASS-(*) | SM11B-PASS-1-(*) | 20.0 | 26.0 | 1,000 |
| 12 | SM12B-PASS-(*) | SM12B-PASS-1-(*) | 22.0 | 28.0 | 1,000 |
| 13 | SM13B-PASS-(*) | SM13B-PASS-1-(*) | 24.0 | 30.0 | 1,000 |
| 15 | SM15B-PASS-(*) | SM15B-PASS-1-(*) | 28.0 | 34.0 | 1,000 |

Material and Finish

Post: Copper alloy, copper-undercoated, tin-plated (reflow treatment)
 Wafer: PA, UL94V-0, natural (ivory)
 Solder tab: Copper alloy, copper-undercoated, tin-plated (reflow treatment)

RoHS compliance This product displays (LF)(SN) on a label.

Note: (*) : TF...taping product

TFT...taping product with suction tape.

RoHS compliance This product displays (LF)(SN) on a label.

Note: (*) : TB...taping product

TBT...taping product with suction tape.

PA FAMILY SERIES /PA CONNECTOR (Crimp style Retainer mountable type)

Contact



| Model No. | Applicable wire | | Insulation O.D. (mm) | Q'ty/reel |
|---------------|-----------------|-------|----------------------|-----------|
| | mm ² | AWG # | | |
| SPA-001T-P0.5 | 0.13~0.33 | 26~22 | 0.9~1.5 | 10,000 |

Material and Finish

Phosphor bronze, tin-plated (reflow treatment)

RoHS compliance

| Contact | Crimping machine | Applicator | | |
|---------------|------------------|------------------|---------------|----------------------------|
| | | Crimp applicator | Dies | Crimp applicator with dies |
| SPA-001T-P0.5 | AP-K2N | MKS-L | MK/SPA-001-05 | APLMK SPA001-05 |
| | | — | — | — |

Housing

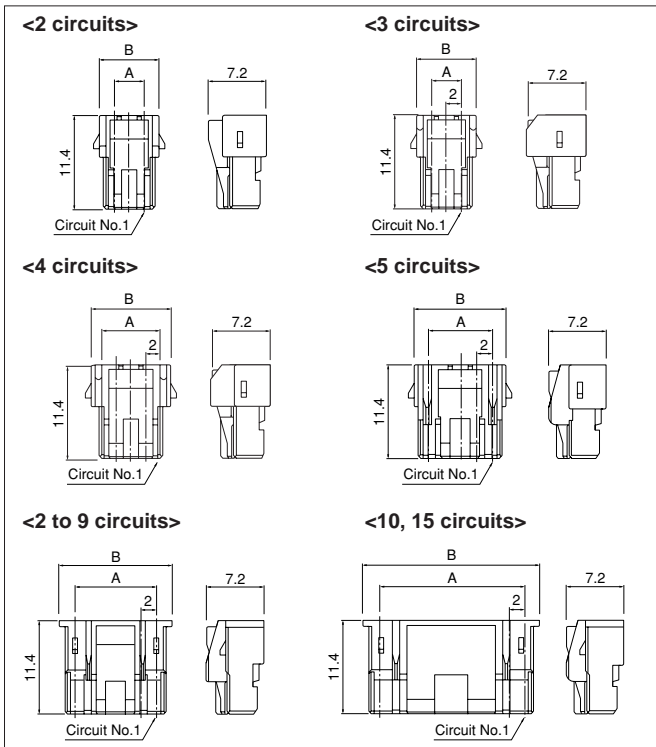

| Circuits | Model No. | Dimensions (mm) | | Q'ty/bag |
|----------|-----------|-----------------|------|----------|
| | | A | B | |
| 2 | PARP-02V | 2.0 | 5.4 | 1,000 |
| 3 | PARP-03V | 4.0 | 7.4 | 1,000 |
| 4 | PARP-04V | 6.0 | 9.4 | 1,000 |
| 5 | PARP-05V | 8.0 | 11.4 | 1,000 |
| 6 | PARP-06V | 10.0 | 14.0 | 1,000 |
| 7 | PARP-07V | 12.0 | 16.0 | 1,000 |
| 8 | PARP-08V | 14.0 | 18.0 | 1,000 |
| 9 | PARP-09V | 16.0 | 20.0 | 1,000 |
| 10 | PARP-10V | 18.0 | 22.0 | 1,000 |
| 15 | PARP-15V | 28.0 | 32.0 | 500 |

Material

PA 66, UL94V-0, natural (white)

RoHS compliance

Note: Contact JST for Glow Wire compliant connectors.

<For reference> As the color identification, the following alphabet shall be put in the underlined part. For availability, delivery and minimum order quantity, contact JST.

ex. **PARP-02V-oo**
 (blank)...natural (white)
 R...red E...blue Y...yellow M...green

Retainer

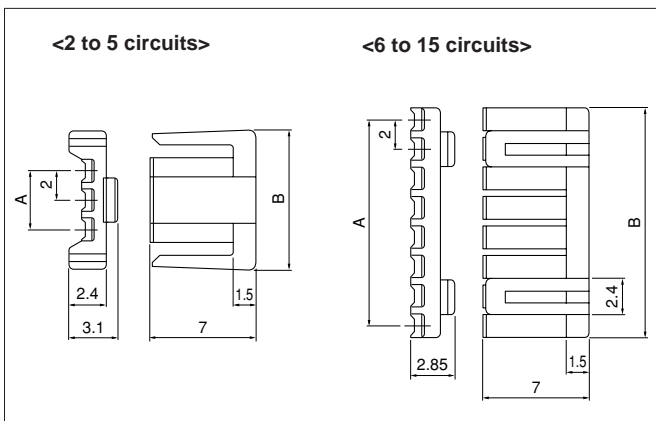

| Circuits | Model No. | Dimensions (mm) | | Q'ty/bag |
|----------|-----------|-----------------|-------|----------|
| | | A | B | |
| 2 | PMS-02V-S | 2.0 | 7.3 | 1,000 |
| 3 | PMS-03V-S | 4.0 | 9.3 | 1,000 |
| 4 | PMS-04V-S | 6.0 | 11.3 | 1,000 |
| 5 | PMS-05V-S | 8.0 | 13.3 | 1,000 |
| 6 | PMS-06V-S | 10.0 | 11.55 | 1,000 |
| 7 | PMS-07V-S | 12.0 | 13.55 | 1,000 |
| 8 | PMS-08V-S | 14.0 | 15.55 | 1,000 |
| 9 | PMS-09V-S | 16.0 | 17.55 | 1,000 |
| 10 | PMS-10V-S | 18.0 | 19.55 | 1,000 |
| 15 | PMS-15V-S | 28.0 | 29.55 | 1,000 |

Material

Glass-filled PA 66, UL94V-0, natural (ivory)

RoHS compliance

PA FAMILY SERIES /PAF CONNECTOR (Insulation displacement type)

Receptacle



| Circuits | Model No. | Dimensions (mm) | | Q'ty/ box |
|----------|-----------------|-----------------|------|--------------|
| | | A | B | |
| 2 | 02PAF-6S | 2.0 | 6.0 | 1,000 |
| 3 | 03PAF-6S | 4.0 | 8.0 | 1,000 |
| 4 | 04PAF-6S | 6.0 | 10.0 | 500 |
| 5 | 05PAF-6S | 8.0 | 12.0 | 500 |
| 6 | 06PAF-6S | 10.0 | 14.0 | 500 |
| 7 | 07PAF-6S | 12.0 | 16.0 | 500 |
| 8 | 08PAF-6S | 14.0 | 18.0 | 250 |
| 9 | 09PAF-6S | 16.0 | 20.0 | 250 |
| 10 | 10PAF-6S | 18.0 | 22.0 | 250 |
| 11 | 11PAF-6S | 20.0 | 24.0 | 250 |
| 12 | 12PAF-6S | 22.0 | 26.0 | 250 |
| 13 | 13PAF-6S | 24.0 | 28.0 | 250 |
| 14 | 14PAF-6S | 26.0 | 30.0 | 250 |
| 15 | 15PAF-6S | 28.0 | 32.0 | 250 |
| *16 | 16PAF-6S | 30.0 | 34.0 | 250 |

Material and Finish

Contact: Phosphor bronze, tin-plated (reflow treatment)

Housing: PA 66, UL94V-0, natural (white)

RoHS compliance

Note: *Marked product is not UL/CSA approved.

<For reference> As the color identification, the following alphabet shall be put in the underlined part. For availability, delivery and minimum order quantity, contact JST.

ex. **02PAF-6S**

S...natural (white)

R...red E...blue M...green Y...yellow

Retainer



| Circuits | Model No. | Dimensions (mm) | | Q'ty/ bag |
|----------|-------------------|-----------------|------|--------------|
| | | A | B | |
| 2 | PAFS-02V-S | 2.0 | 7.4 | 1,000 |
| 3 | PAFS-03V-S | 4.0 | 9.4 | 1,000 |
| 4 | PAFS-04V-S | 6.0 | 11.4 | 1,000 |
| 5 | PAFS-05V-S | 8.0 | 13.4 | 1,000 |
| 6 | PAFS-06V-S | 10.0 | 15.4 | 1,000 |
| 7 | PAFS-07V-S | 12.0 | 17.4 | 1,000 |
| 8 | PAFS-08V-S | 14.0 | 19.4 | 1,000 |
| * 9 | PAFS-09V-S | 16.0 | 21.4 | 1,000 |
| *10 | PAFS-10V-S | 18.0 | 23.4 | 1,000 |
| *11 | PAFS-11V-S | 20.0 | 25.4 | 1,000 |
| *12 | PAFS-12V-S | 22.0 | 27.4 | 1,000 |
| *13 | PAFS-13V-S | 24.0 | 29.4 | 1,000 |
| *14 | PAFS-14V-S | 26.0 | 31.4 | 1,000 |
| *15 | PAFS-15V-S | 28.0 | 33.4 | 1,000 |

Material

Glass-filled PA 66, UL94V-0, natural (ivory)

RoHS compliance

Note: *Marked products are not UL/CSA approved.

PA FAMILY SERIES /PAL CONNECTOR (Wire-to-wire type)

Contact



| Model No. | Applicable wire | | Insulation O.D. (mm) | Q'ty/ reel |
|----------------|-----------------|-------|-------------------------|---------------|
| | mm ² | AWG # | | |
| SPAL-001T-P0.5 | 0.13~0.33 | 26~22 | 1.0~1.5 | 10,000 |
| SPAL-002T-P0.5 | 0.08~0.21 | 28~24 | 0.9~1.5 | 10,000 |

Material and Finish

Phosphor bronze, tin-plated (reflow treatment)

RoHS compliance

| Contact | Crimping machine | Applicator | | |
|----------------|---------------------|------------------|----------------|----------------------------|
| | | Crimp applicator | Dies | Crimp applicator with dies |
| SPAL-001T-P0.5 | AP-K2N | MKS-L | MK/SPAL-001-05 | APLMK SPAL001-05 |
| | | — | — | — |
| SPAL-002T-P0.5 | AP-K2N | MKS-L | MK/SPAL-002-05 | APLMK SPAL002-05 |
| | | — | — | — |

Housing



| Circuits | Model No. | Dimensions (mm) | | Q'ty/ bag |
|----------|-----------|-----------------|------|--------------|
| | | A | B | |
| 2 | PALR-02VF | 2.0 | 9.4 | 1,000 |
| 3 | PALR-03VF | 4.0 | 11.4 | 1,000 |
| 4 | PALR-04VF | 6.0 | 13.4 | 1,000 |
| 5 | PALR-05VF | 8.0 | 15.4 | 1,000 |
| 6 | PALR-06VF | 10.0 | 17.4 | 1,000 |
| 7 | PALR-07VF | 12.0 | 19.4 | 1,000 |
| 8 | PALR-08VF | 14.0 | 21.4 | 1,000 |

Material

PA 66, UL94V-0, natural (white)

RoHS compliance

| Circuits | Model No. | Dimensions (mm) | | | | Q'ty/ bag |
|----------|-----------|-----------------|------|------|------|--------------|
| | | A | B | C | D | |
| 2 | PALR-02V | 2.0 | 9.4 | 9.8 | 13.4 | 1,000 |
| 3 | PALR-03V | 4.0 | 11.4 | 11.8 | 15.4 | 1,000 |
| 4 | PALR-04V | 6.0 | 13.4 | 13.8 | 17.4 | 1,000 |
| 6 | PALR-06V | 10.0 | 17.4 | 19.8 | 21.4 | 1,000 |
| 7 | PALR-07V | 12.0 | 19.4 | 21.8 | 23.4 | 1,000 |
| 8 | PALR-08V | 14.0 | 21.4 | 23.8 | 25.4 | 1,000 |

Material

PA 66, UL94V-0, natural (white)

RoHS compliance

<For reference> As the color identification, the following alphabet shall be put in the underlined part. For availability, delivery and minimum order quantity, contact JST.

ex. **PALR-02V(F)-oo**
(blank)...natural (white)
R...red E...blue M...green Y...yellow

Retainer

Retainers are interchangeable with those of the PA crimp style retainer mountable type.

X-ON Electronics

Largest Supplier of Electrical and Electronic Components

Click to view similar products for [Headers & Wire Housings](#) category:

Click to view products by [JST](#) manufacturer:

Other Similar products are found below :

[95000-104TRLF](#) [10135584-644402LF](#) [DF62W-EP2022PCA](#) [95000-106TRLF](#) [DF62W-2022SCA](#) [DF62W-EP2022PC](#) [2203348](#) [DF62W-2022SC](#) [1084018](#) [1029039](#) [1084017](#) [802-10-012-10-002000](#) [1112640](#) [1112639](#) [891-007-9SS-BST1T](#) [000-34000](#) [0008550134](#) [0009482033](#) [0009507031](#) [57102-F02-18ULF](#) [57102-S06-03LF](#) [57202-S52-04LF](#) [PCN6-15S-2.5E](#) [0039019024](#) [58102-G61-06LF](#) [582553-1](#) [0009485154](#) [0009508121](#) [0022285053](#) [0050291907](#) [018731A](#) [LY20-4P-DT1-P1E-BR](#) [02.125.8002.8](#) [60101931](#) [60598-1 \(Cut Strip\)](#) [M1625-3R/100](#) [61062-3](#) [61082-181009](#) [CSU011177004](#) [636-1427](#) [638009-1](#) [641938-9](#) [641991-4](#) [644168-1](#) [644827-2](#) [647662-1](#) [65039-019ELF](#) [65692-001LF](#) [65781-018](#) [65781-047](#)