

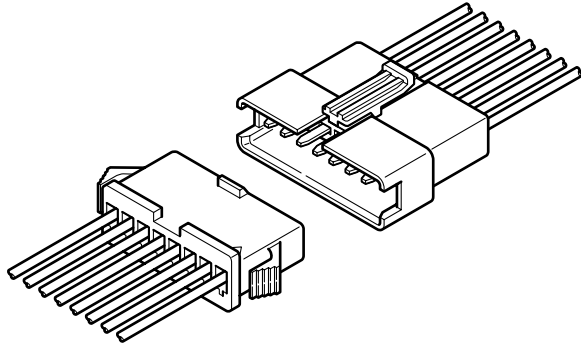

SM CONNECTOR

2.5mm pitch/Disconnectable Crimp style wire-to-wire connectors



The SM series are 2.5mm pitch, wire-to-wire connectors that perform reliably in high-density, small current applications.

- High contact pressure
- Highly reliable housing construction
- Mountable on a variety of panels
- Arm lock mechanism

Specifications

- Current rating: 3A AC, DC max.
 - Voltage rating: 250V AC, DC max.
 - Temperature range: -25°C to +85°C
(including temperature rise in applying electrical current)
 - Contact resistance: Initial value/ 10m Ω max.
After environmental testing/ 20m Ω max.
 - Insulation resistance: 500M Ω min.
 - Withstanding voltage: 1,500V AC/minute
 - Applicable wire: AWG #28 to #22
0.08 to 0.33mm²
 - Applicable panel thickness: 0.5 to 2.0mm
- * Compliant with RoHS.
* Refer to "General Instruction and Notice when using Terminals and Connectors" at the end of this catalog.
* Contact JST for details.

Standards

Recognized E60389

Certified LR20812

R50120150

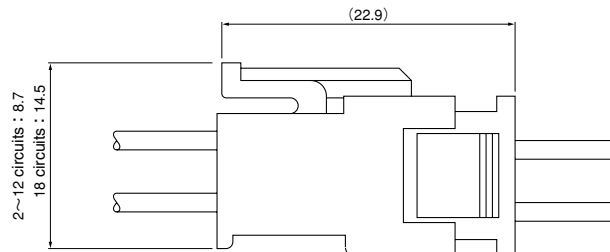

(2 to 12 circuits)

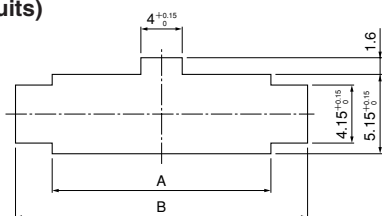

(18 circuits)

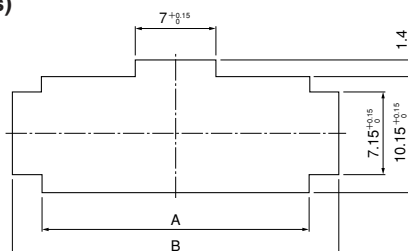

| Circuits | Plug housing Model No. | Panel thickness (mm) | | | | | |
|----------|------------------------|--|-------------------|----------------------|-------------------|----------------------|-------------------|
| | | 0.5~0.9 | | 1.0~1.5 | | 1.5~2.0 | |
| | | Panel hole dimensions (mm) General tolerance | | | | | |
| | | A ^{+0.15/0} | B ^{±0.1} | A ^{+0.15/0} | B ^{±0.1} | A ^{+0.15/0} | B ^{±0.1} |
| 2 | SMP-02V-B(N)C | 5.7 | 9.6 | 5.7 | 9.8 | 5.7 | 10.0 |
| 3 | SMP-03V-B(N)C | 8.2 | 12.1 | 8.2 | 12.3 | 8.2 | 12.5 |
| 4 | SMP-04V-B(N)C | 10.7 | 14.6 | 10.7 | 14.8 | 10.7 | 15.0 |
| 5 | SMP-05V-B(N)C | 13.2 | 17.1 | 13.2 | 17.3 | 13.2 | 17.5 |
| 6 | SMP-06V-B(N)C | 15.7 | 19.6 | 15.7 | 19.8 | 15.7 | 20.0 |
| 7 | SMP-07V-B(N)C | 18.2 | 22.1 | 18.2 | 22.3 | 18.2 | 22.5 |
| 8 | SMP-08V-B(N)C | 20.7 | 24.6 | 20.7 | 24.8 | 20.7 | 25.0 |
| 9 | SMP-09V-B(N)C | 23.2 | 27.1 | 23.2 | 27.3 | 23.2 | 27.5 |
| 10 | SMP-10V-B(N)C | 25.7 | 29.6 | 25.7 | 29.8 | 25.7 | 30.0 |
| 11 | SMP-11V-B(N)C | 28.2 | 32.1 | 28.2 | 32.3 | 28.2 | 32.5 |
| 12 | SMP-12V-B(N)C | 30.7 | 34.6 | 30.7 | 34.8 | 30.7 | 35.0 |
| 18 | SMP-18V-B(N)C | 23.2 | 27.2 | 23.2 | 27.4 | 23.2 | 27.6 |

Note: 1. Punch holes in the panel according to the sketch and table shown above. Burrs must be removed.
2. The strength of the panel must be considered when punching two or more holes.
3. The connector must be inserted from the same side as the hole is punched.

SM CONNECTOR

Contact

Pin contact

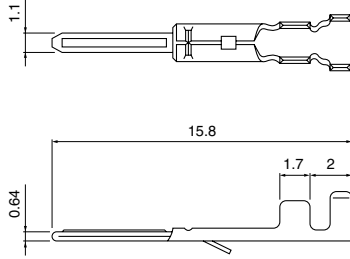

Socket contact

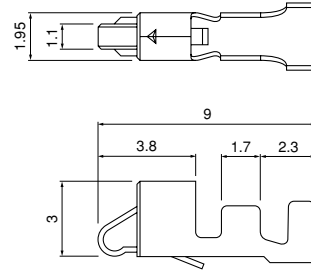

| Model No. | | Applicable wire | | Insulation O.D. (mm) | Q'ty / reel |
|----------------------|-----------------------|-----------------|-------|----------------------|---|
| Pin contact | Socket contact | mm ² | AWG # | | |
| SYM-001T-P0.6 | SHF-001T-0.8BS | 0.08~0.33 | 28~22 | 1.2~1.8 | Pin contact: 8,500 Socket contact: 5,000 |

Material and Finish

Phosphor bronze, tin-plated (reflow treatment)

RoHS compliance

Note: 1. Contact JST for special products.
2. Contact JST for brass products.

| Contact | Crimping machine | Applicator | | |
|----------------------|------------------|------------------|---------------|----------------------------|
| | | Crimp applicator | Dies | Crimp applicator with dies |
| SYM-001T-P0.6 | AP-K2N | MKS-L | MK/SYM-001-06 | APLMK SYM001-06 |
| | | *MKS-SC | SC/SYM-001-06 | APLSC SYM001-06 |

| Contact | Crimping machine | Applicator | | |
|-----------------------|------------------|------------------|----------------|----------------------------|
| | | Crimp applicator | Dies | Crimp applicator with dies |
| SHF-001T-0.8BS | AP-K2N | MKS-L | MK/SHF-001-08S | APLMK SHF001-08S |
| | | *MKS-SC | SC/SHF-001-08S | APLSC SHF001-08S |

Note: *Strip-crimp applicator

Contact position location numbers

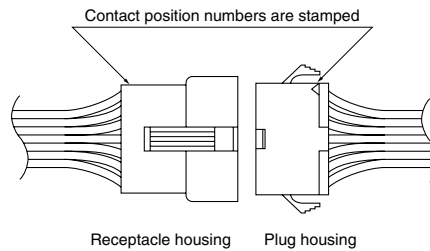

Receptacle housing

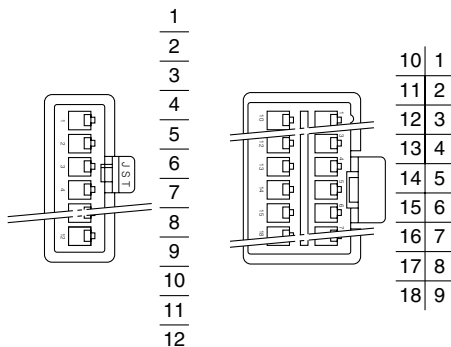

Plug housing

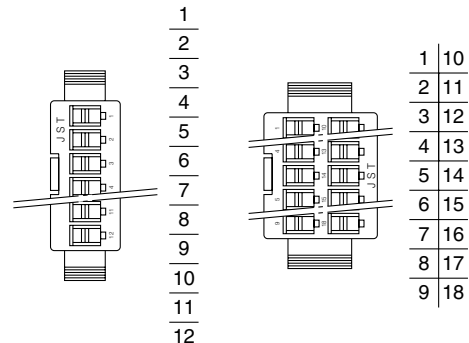

SM CONNECTOR

Housing

Material: PA 6, UL94V-0

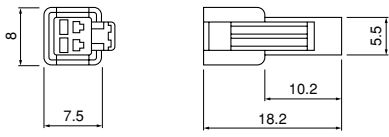
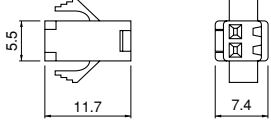
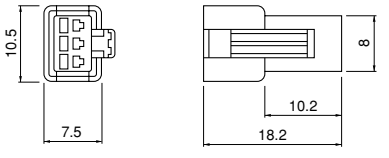
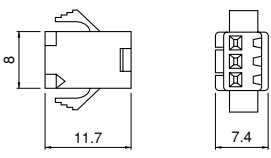
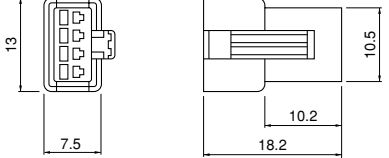
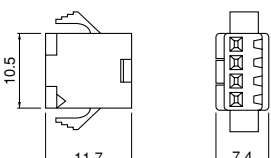
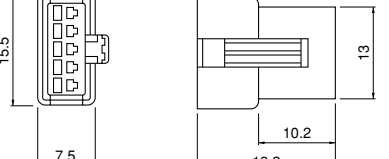
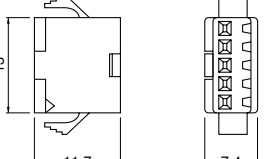
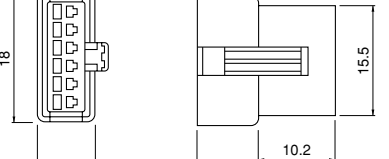
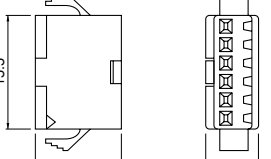
| Circuits | Current rating | Receptacle housing(for pin contact) | Q'ty / bag | Plug housing(for socket contact) | Q'ty / bag |
|----------|----------------|--|------------|--|------------|
| 2 | 3A | SMR-02V-B, black SMR-02V-N, white (natural)  | 1,000 | SMP-02V-BC, black SMP-02V-NC, white (natural)  | 1,000 |
| 3 | 3A | SMR-03V-B, black SMR-03V-N, white (natural)  | 1,000 | SMP-03V-BC, black SMP-03V-NC, white (natural)  | 1,000 |
| 4 | 3A | SMR-04V-B, black SMR-04V-N, white (natural)  | 500 | SMP-04V-BC, black SMP-04V-NC, white (natural)  | 1,000 |
| 5 | 3A | SMR-05V-B, black SMR-05V-N, white (natural)  | 500 | SMP-05V-BC, black SMP-05V-NC, white (natural)  | 1,000 |
| 6 | 3A | SMR-06V-B, black SMR-06V-N, white (natural)  | 500 | SMP-06V-BC, black SMP-06V-NC, white (natural)  | 500 |

RoHS compliance

SM CONNECTOR

Housing

Material: PA 6, UL94V-0

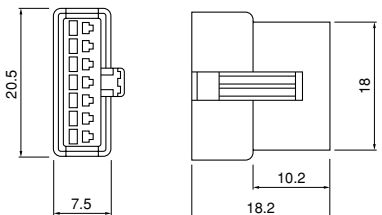
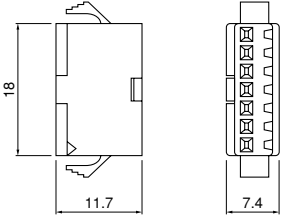
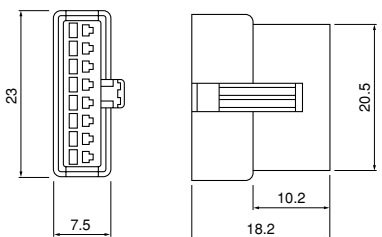
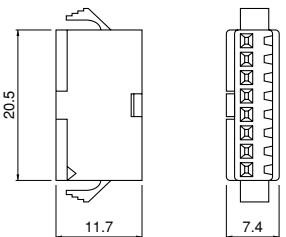
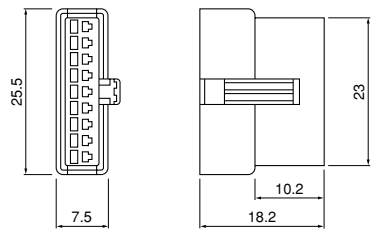
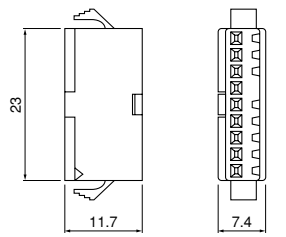
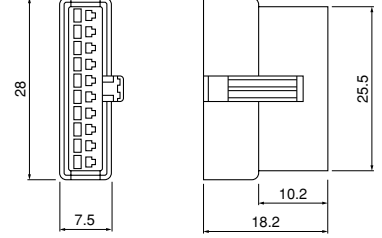
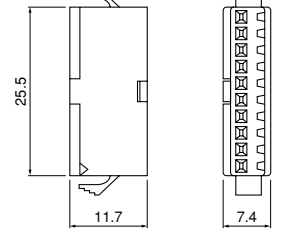
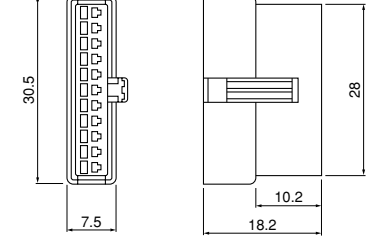
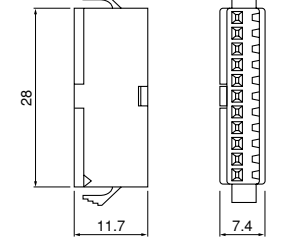
| Circuits | Current rating | Receptacle housing(for pin contact) | | Plug housing(for socket contact) | |
|----------|----------------|--|-------------------|---|-------------------|
| 7 | 3A | SMR-07V-B , black SMR-07V-N , white (natural)  | Q'ty / bag 500 | SMP-07V-BC , black SMP-07V-NC , white (natural)  | Q'ty / bag 500 |
| 8 | 3A | SMR-08V-B , black SMR-08V-N , white (natural)  | Q'ty / bag 500 | SMP-08V-BC , black SMP-08V-NC , white (natural)  | Q'ty / bag 500 |
| 9 | 3A | SMR-09V-B , black SMR-09V-N , white (natural)  | Q'ty / bag 500 | SMP-09V-BC , black SMP-09V-NC , white (natural)  | Q'ty / bag 500 |
| 10 | 3A | SMR-10V-B , black SMR-10V-N , white (natural)  | Q'ty / bag 200 | SMP-10V-BC , black SMP-10V-NC , white (natural)  | Q'ty / bag 500 |
| 11 | 3A | SMR-11V-B , black SMR-11V-N , white (natural)  | Q'ty / bag 200 | SMP-11V-BC , black SMP-11V-NC , white (natural)  | Q'ty / bag 500 |

RoHS compliance

SM CONNECTOR

Housing

Material: PA 6, UL94V-0

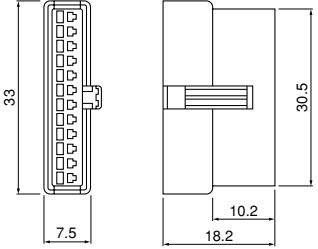
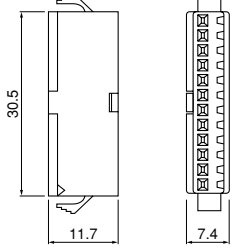
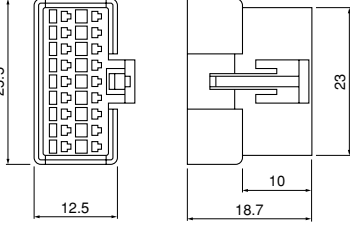
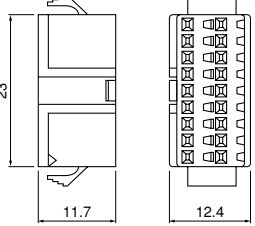
| Circuits | Current rating | Receptacle housing(for pin contact) | Q'ty / bag | Plug housing(for socket contact) | Q'ty / bag |
|----------|----------------|---|------------|---|------------|
| 12 | 3A | SMR-12V-B, black SMR-12V-N, white (natural)  | 500 | SMP-12V-BC, black SMP-12V-NC, white (natural)  | 500 |
| 18 | 2A | SMR-18V-B, black SMR-18V-N, white (natural)  | 200 | SMP-18V-BC, black SMP-18V-NC, white (natural)  | 200 |

RoHS compliance

Note: 1. SM connectors with any number of circuits can be used either panel mounted or free hanging.
 2. Contact JST for special products.

X-ON Electronics

Largest Supplier of Electrical and Electronic Components

Click to view similar products for [Headers & Wire Housings](#) category:

Click to view products by [JST](#) manufacturer:

Other Similar products are found below :

[95000-104TRLF](#) [10135584-644402LF](#) [DF62W-EP2022PCA](#) [95000-106TRLF](#) [DF62W-2022SCA](#) [DF62W-EP2022PC](#) [2203348](#) [DF62W-2022SC](#) [1084018](#) [1029039](#) [1084017](#) [802-10-012-10-002000](#) [1112640](#) [1112639](#) [891-007-9SS-BST1T](#) [000-34000](#) [0008550134](#) [0009482033](#) [0009507031](#) [57102-F02-18ULF](#) [57102-S06-03LF](#) [57202-S52-04LF](#) [PCN6-15S-2.5E](#) [0039019024](#) [58102-G61-06LF](#) [582553-1](#) [0009485154](#) [0009508121](#) [0022285053](#) [0050291907](#) [018731A](#) [LY20-4P-DT1-P1E-BR](#) [02.125.8002.8](#) [60101931](#) [60598-1 \(Cut Strip\)](#) [M1625-3R/100](#) [61062-3](#) [61082-181009](#) [CSU011177004](#) [636-1427](#) [638009-1](#) [641938-9](#) [641991-4](#) [644168-1](#) [644827-2](#) [647662-1](#) [65039-019ELF](#) [65692-001LF](#) [65781-018](#) [65781-047](#)